

## Programmable Controller

---

# Transition from MELSEC-A/QnA (Large Type), AnS/QnAS (Small Type) Series to Q Series Handbook

---

(Network Modules)

MELSEC-A/QnA

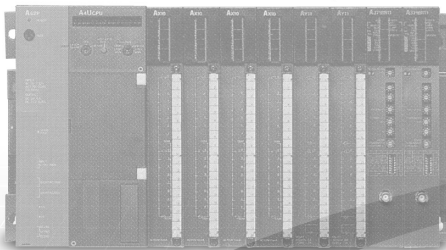

MELSEC-AnS/QnAS

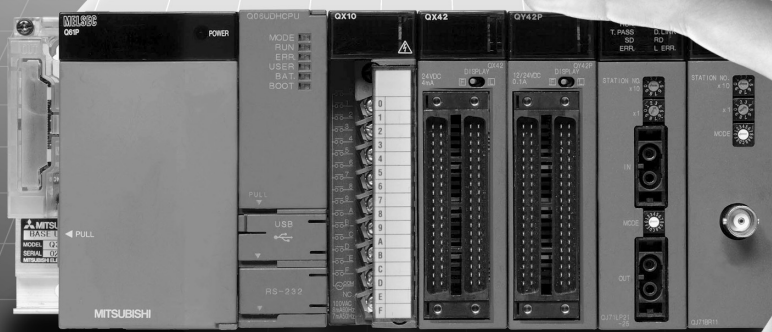

MELSEC  series



## ● SAFETY PRECAUTIONS ●

(Read these precautions before using this product.)

Before using this product, please read this handbook and the relevant manuals introduced in this handbook carefully and pay full attention to safety to handle the product correctly.

In this handbook, the safety precautions are classified into two levels: "⚠️ WARNING" and "⚠️ CAUTION".



Indicates that incorrect handling may cause hazardous conditions, resulting in death or severe injury.



Indicates that incorrect handling may cause hazardous conditions, resulting in minor or moderate injury or property damage.

Under some circumstances, failure to observe the precautions given under "⚠️ CAUTION" may lead to serious consequences.

Observe the precautions of both levels because they are important for personal and system safety.

Make sure that the end users read this handbook and then keep the handbook in a safe place for future reference.

## [Design Precautions]

### WARNING

- For the operating status of each station after a communication failure in the data link or the network, refer to the following manuals.  
Failure to do so may result in an accident due to an incorrect output or malfunction.
  - Q Corresponding MELSECNET/H Network System Reference Manual (PLC to PLC network)
  - Q Corresponding MELSECNET/H Network System Reference Manual (Remote I/O network)
  - Q Corresponding MELSECNET/H Remote I/O Module Reference Manual (MELSECNET/10 Mode)
  - CC-Link System Master/Local Module User's Manual
- If a coaxial cable is disconnected, the network may be unstable, resulting in a communication failure of multiple stations. Configure an interlock circuit in the program to ensure that the entire system will always operate safely even if communications fail. Failure to do so may result in an accident due to an incorrect output or malfunction.
- When connecting a peripheral with the CPU module or connecting a personal computer with an intelligent function module to modify data of a running programmable controller, configure an interlock circuit in the program to ensure that the entire system will always operate safely.  
For other forms of control (such as program modification or operating status change) of a running programmable controller, read the relevant manuals carefully and ensure that the operation is safe before proceeding. Especially, when a remote programmable controller is controlled by an external device, immediate action cannot be taken if a problem occurs in the programmable controller due to a communication failure. To prevent this, configure an interlock circuit in the program, and determine corrective actions to be taken between the external device and CPU module in case of a communication failure.
- Do not write any data to the "system area" of the buffer memory in each intelligent function module. Do not write any data to the "system area" of the buffer memory in the intelligent function module. Also, do not use any "use prohibited" signals as an output signal from the CPU module to the intelligent function module. Doing so may cause malfunction of the programmable controller system.
- To set the auto refresh parameter, select the device Y for the remote output (RY) refresh device. If a device other than Y is selected, the CPU module holds the device status even after its status is changed to STOP. For how to stop data link, refer to the following manual.
  - CC-Link System Master/Local Module User's Manual
- If a CC-Link dedicated cable is disconnected, the network may be unstable, resulting in a communication failure of multiple stations. Configure an interlock circuit in the program to ensure that the entire system will always operate safely even if communications fail.  
Failure to do so may result in an accident due to an incorrect output or malfunction.

 **CAUTION**

- After changing the parameter of the CPU module or the remote I/O module, reset the CPU module. Failure to do so may cause malfunction, since the previous parameter setting remains in the module.
- Do not install the control lines or communication cables together with the main circuit lines or power cables. Keep a distance of 100mm or more between them. Failure to do so may result in malfunction due to noise.

## [Installation Precautions]

### WARNING

- Shut off the external power supply (all phases) used in the system before mounting or removing a module.  
Failure to do so may result in electric shock or cause the module to fail or malfunction.

### CAUTION

- Use the programmable controller in an environment that meets the general specifications in the user's manual for the CPU module used.  
Failure to do so may result in electric shock, fire, malfunction, or damage to or deterioration of the product.
- To mount a Q series module, while pressing the module mounting lever located in the lower part of the module, fully insert the module fixing projection(s) into the hole(s) in the base unit and press the module until it snaps into place.  
Incorrect mounting may cause malfunction, failure or drop of the module.  
When using the programmable controller in an environment of frequent vibrations, fix the module with a screw.  
Tighten the screw within the specified torque range.  
Undertightening can cause drop of the screw, short circuit or malfunction.  
Overtightening can damage the screw and/or module, resulting in drop, short circuit, or malfunction.
- To mount an A/AnS/QnA/QnAS module, fully insert the module fixing projection(s) located in the lower part of the module into the hole(s) in the base unit and press the module until it snaps into place (To fix an AnS series module to the base unit, tighten the screws within the specified torque range).  
Incorrect mounting may cause malfunction, failure or drop of the module.
- Shut off the external power supply (all phases) used in the system before mounting or removing the module. Failure to do so may result in damage to the product.
- A MELSECNET/H module with function version D or later can be replaced online (while power is on) on any remote I/O station. Note that there are restrictions on the modules that can be replaced online, and each module has its predetermined replacement procedure.  
For details, refer to the relevant section in the following.
  - Q Corresponding MELSECNET/H Network System Reference Manual (Remote I/O network)
- Do not directly touch any conductive parts and electronic components of the module.  
Doing so can cause malfunction or failure of the module.

## [Wiring Precautions]

### **WARNING**

- Shut off the external power supply (all phases) used in the system before wiring.  
Failure to do so may result in electric shock or cause the module to fail or malfunction.
- After installation and wiring, attach the included terminal cover to the module before turning it on for operation.  
Failure to do so may result in electric shock.

### **CAUTION**

- Ground the FG terminal to the protective ground conductor dedicated to the programmable controller. Failure to do so may result in malfunction.
- Check the rated voltage and terminal layout before wiring the external power supply terminal block, and connect the cables correctly.  
Connecting a power supply with a different voltage rating or incorrect wiring may cause a fire or failure.
- Use applicable solderless terminals and tighten them within the specified torque range. If any spade solderless terminal is used, it may be disconnected when the terminal screw comes loose, resulting in failure.
- Correctly solder coaxial cable connectors. Incomplete soldering may result in malfunction.
- Do not install the control lines or communication cables together with the main circuit lines or power cables.  
Failure to do so may result in malfunction due to noise.
- Place the cables in a duct or clamp them.  
If not, dangling cable may swing or inadvertently be pulled, resulting in damage to the module or cables or malfunction due to poor contact.
- Tighten the terminal screw within the specified torque range.  
Undertightening can cause short circuit or malfunction.  
Overtightening can damage the screw and/or module, resulting in drop, short circuit, fire, or malfunction.
- When disconnecting the cable from the module, do not pull the cable by the cable part.  
For the cable with connector, hold the connector part of the cable.  
For the cable connected to the terminal block, loosen the terminal block screws.  
Pulling the cable connected to the module may result in malfunction and damage to the module or cable.

## [Wiring Precautions]

### CAUTION

- Mitsubishi Electric programmable controllers must be installed in control panels.  
Connect the main power supply to the power supply module in the control panel through a relay terminal block.  
Wiring and replacement of a power supply module must be performed by qualified maintenance personnel with knowledge of protection against electric shock. For wiring methods, refer to the QCPU User's Manual (Hardware Design, Maintenance and Inspection).
- Prevent foreign matter such as dust or wire chips from entering the module.  
Such foreign matter can cause a fire, failure, or malfunction.
- A protective film is attached to the top of the module to prevent foreign matter, such as wire chips, from entering the module during wiring.  
Do not remove the film during wiring.  
Remove it for heat dissipation before system operation.
- Use CC-Link dedicated cables for the CC-Link system. If not, the performance of the CC-Link system is not guaranteed.  
For the maximum station-to-station distance and the overall cable distance, follow the specifications in the following.  
If not, normal data transmission will not be guaranteed.
  - CC-Link System Master/Local Module User's Manual

## [Startup and Maintenance Precautions]

### WARNING

- Do not touch any terminal while power is on.  
Doing so will cause electric shock or malfunction.
- Shut off the external power supply (all phases) used in the system before cleaning the module or retightening the terminal screws or module fixing screws. Failure to do so may result in electric shock.



## [Startup and Maintenance Precautions]

### CAUTION

- Before performing online operations (especially, program modification, forced output, and operating status change) for the running CPU module on another station from GX Developer over the MELSECNET/H network, read relevant manuals carefully and ensure the safety.  
Improper operation may damage machines or cause accidents.
- Do not disassemble or modify the modules.  
Doing so may cause failure, malfunction, injury, or a fire.
- Use any radio communication device such as a cellular phone or PHS (Personal Handy-phone System) more than 25cm away in all directions from the programmable controller.  
Failure to do so may cause malfunction.
- Shut off the external power supply (all phases) used in the system before mounting or removing a module. Failure to do so may cause the module to fail or malfunction.  
A MELSECNET/H module with function version D or later can be replaced online (while power is on) on any remote I/O station.  
Note that there are restrictions on the modules that can be replaced online, and each module has its predetermined replacement procedure. For details, refer to the relevant section in the following manual.
  - Q Corresponding MELSECNET/H Network System Reference Manual (Remote I/O network)
- Do not touch any terminal while power is on.  
Doing so will cause malfunction.
- Tighten the module fixing screw and the terminal screw within the specified torque range.  
Undertightening can cause drop of the component or wire, short circuit, or malfunction.  
Overtightening can damage the screw and/or module, resulting in drop, short circuit, or malfunction.
- After the first use of the product, do not mount/remove the module to/from the base unit, and the terminal block to/from the module more than 50 times (IEC 61131-2 compliant) respectively.  
Exceeding the limit of 50 times may cause malfunction.
- Before handling the module, touch a grounded metal object to discharge the static electricity from the human body.  
Failure to do so may cause the module to fail or malfunction.

## [Disposal Precautions]

### CAUTION

- When disposing of this product, treat it as industrial waste.

## ● CONDITIONS OF USE FOR THE PRODUCT ●

- (1) Mitsubishi programmable controller ("the PRODUCT") shall be used in conditions;
  - i) where any problem, fault or failure occurring in the PRODUCT, if any, shall not lead to any major or serious accident; and
  - ii) where the backup and fail-safe function are systematically or automatically provided outside of the PRODUCT for the case of any problem, fault or failure occurring in the PRODUCT.
- (2) The PRODUCT has been designed and manufactured for the purpose of being used in general industries.

MITSUBISHI SHALL HAVE NO RESPONSIBILITY OR LIABILITY (INCLUDING, BUT NOT LIMITED TO ANY AND ALL RESPONSIBILITY OR LIABILITY BASED ON CONTRACT, WARRANTY, TORT, PRODUCT LIABILITY) FOR ANY INJURY OR DEATH TO PERSONS OR LOSS OR DAMAGE TO PROPERTY CAUSED BY the PRODUCT THAT ARE OPERATED OR USED IN APPLICATION NOT INTENDED OR EXCLUDED BY INSTRUCTIONS, PRECAUTIONS, OR WARNING CONTAINED IN MITSUBISHI'S USER, INSTRUCTION AND/OR SAFETY MANUALS, TECHNICAL BULLETINS AND GUIDELINES FOR the PRODUCT.

("Prohibited Application")

Prohibited Applications include, but not limited to, the use of the PRODUCT in;

- Nuclear Power Plants and any other power plants operated by Power companies, and/or any other cases in which the public could be affected if any problem or fault occurs in the PRODUCT.
- Railway companies or Public service purposes, and/or any other cases in which establishment of a special quality assurance system is required by the Purchaser or End User.
- Aircraft or Aerospace, Medical applications, Train equipment, transport equipment such as Elevator and Escalator, Incineration and Fuel devices, Vehicles, Manned transportation, Equipment for Recreation and Amusement, and Safety devices, handling of Nuclear or Hazardous Materials or Chemicals, Mining and Drilling, and/or other applications where there is a significant risk of injury to the public or property.

Notwithstanding the above restrictions, Mitsubishi may in its sole discretion, authorize use of the PRODUCT in one or more of the Prohibited Applications, provided that the usage of the PRODUCT is limited only for the specific applications agreed to by Mitsubishi and provided further that no special quality assurance or fail-safe, redundant or other safety features which exceed the general specifications of the PRODUCTS are required. For details, please contact the Mitsubishi representative in your region.

## REVISIONS

\* The handbook number is given on the bottom left of the back cover.

Print Date	* Handbook Number	Revision
Apr. 2005	L(NA)08048ENG-A	First edition
Oct. 2005	L(NA)08048ENG-B	<p>[Addition]</p> <p>Section 1.1.3, Section 2.5.3, Section 2.5.4, Appendix 1</p> <p>[Partial correction]</p> <p>Contents, Section 2.5.2, Section 2.7, Section 3.5.2, Appendix 1→Appendix 2</p>
Oct. 2006	L(NA)08048ENG-C	<p>[Addition]</p> <p>Chapter 6</p> <p>[Partial correction]</p> <p>Section 1.3, Chapter 6→Chapter 7, Chapter 7→Chapter 8</p>
Jul. 2007	L(NA)08048ENG-D	<p>[Addition]</p> <p>Section 1.1.4, Chapter 7</p> <p>[Partial correction]</p> <p>Section 1.1.3, Chapter 7→Chapter 8, Chapter 8→Chapter 9</p>
Nov. 2012	L(NA)08048ENG-E	<p>Revision on the new functions of the Universal model QCPU with a serial number (first five digits) of "13102" or later</p> <p>[Model Addition]</p> <p>QJ71NT11B, MELSEC-AnS/QnAS series, QA1S51B, 5C-FB</p> <p>[Partial correction]</p> <p>SAFETY PRECAUTIONS, Chapter 1 to 9, Appendix</p>
Mar. 2016	L(NA)08048ENG-F	<p>[Addition]</p> <p>Section 5.2</p> <p>[Change]</p> <p>Chapter 9 → Appendix 1, Appendix 1 → Appendix 2, Appendix 2 → Appendix 3</p> <p>[Partial correction]</p> <p>Cover, Section 1.1, 1.1.3, 1.2, 2.6.2, 4.1, 4.2, 4.4, 4.5, 4.6.2, 5.1, 7.4, Appendix 3.4, WARRANTY</p>
Apr. 2018	L(NA)08048ENG-G	<p>[Deletion]</p> <p>Chapter 6, 7</p> <p>[Change]</p> <p>Chapter 8 → Chapter 6</p> <p>[Partial correction]</p> <p>SAFETY PRECAUTIONS, GENERIC TERMS AND ABBREVIATIONS, Section 1.1, 2.3, 2.4, 2.5, 2.7, 3.3, 3.4, 3.5.2, 3.7, 4.3, 4.4, 4.5, 5.1, 5.2.4, 6.1, 6.2.1, Appendix 3.1, 3.4</p>

Print Date	* Handbook Number	Revision
Mar. 2020	L(NA)08048ENG-H	<div style="border: 1px solid black; display: inline-block; padding: 2px;">Addition</div> Appendix 3 <div style="border: 1px solid black; display: inline-block; padding: 2px;">Change</div> Appendix 3 → Appendix 4 <div style="border: 1px solid black; display: inline-block; padding: 2px;">Partial correction</div> Section 1.1
Mar. 2020	L(NA)08048ENG-I	<div style="border: 1px solid black; display: inline-block; padding: 2px;">Partial correction</div> Front cover, back cover
Sep. 2023	L(NA)08048ENG-J	<div style="border: 1px solid black; display: inline-block; padding: 2px;">Partial correction</div> Chapter 2, 3, 4, 5, 6

Japanese Handbook Version L08047-Q

This handbook confers no industrial property rights or any rights of any other kind, nor does it confer any patent licenses. Mitsubishi Electric Corporation cannot be held responsible for any problems involving industrial property rights which may occur as a result of using the contents noted in this handbook.

© 2005 MITSUBISHI ELECTRIC CORPORATION

# CONTENTS

SAFETY PRECAUTIONS .....	A - 1
CONDITIONS OF USE FOR THE PRODUCT .....	A - 8
REVISIONS .....	A - 9
CONTENTS .....	A - 11
GENERIC TERMS AND ABBREVIATIONS .....	A - 15

---

## **CHAPTER 1 INTRODUCTION** **1 - 1 to 1 - 17**

---

1.1 Transition from MELSECNET (II) and /B to MELSECNET/H .....	1 - 1
1.2 Replacement of the MELSECNET/10 for A/AnS/QnA/QnAS Series with the MELSECNET/H for Q Series .....	1 - 13
1.3 Replacing the CC-Link for A/AnS/QnA/QnAS Series with the CC-Link for Q Series .....	1 - 17

---

## **CHAPTER 2 REPLACEMENT OF MELSECNET (II) AND /B (PLC TO PLC NETWORK)** **2 - 1 to 2 - 75**

---

2.1 List of MELSECNET (II) and /B Alternative Models .....	2 - 1
2.2 Specifications Comparisons .....	2 - 3
2.2.1 Module specifications comparisons .....	2 - 3
2.2.2 Cable performance comparisons .....	2 - 7
2.3 Functional Comparisons .....	2 - 10
2.4 Switch Settings Comparisons .....	2 - 11
2.5 Parameter Comparisons .....	2 - 12
2.5.1 Parameter comparisons .....	2 - 12
2.5.2 Example of changing parameters on 2-tier system .....	2 - 13
2.5.3 Example of changing parameters on 3-tier system (When only the first half of link parameter is set) .....	2 - 27
2.5.4 Example of changing parameters on 3-tier system (When the first half/second half of link parameter is set) .....	2 - 43
2.6 Program Comparisons .....	2 - 63
2.6.1 Comparison of special relays M (SB) and special registers D (SW) .....	2 - 63
2.6.2 Transient instructions .....	2 - 70
2.7 Replacement Precautions .....	2 - 72

---

## **CHAPTER 3 REPLACEMENT OF MELSECNET (II) AND /B (REMOTE I/O NETWORK)** **3 - 1 to 3 - 29**

---

3.1 List of MELSECNET (II) and /B Alternative Models .....	3 - 1
3.2 Specifications Comparisons .....	3 - 3
3.2.1 Module specifications comparisons .....	3 - 3
3.2.2 Cable performance comparisons .....	3 - 8
3.3 Functional Comparisons .....	3 - 10

3.4	Switch Settings Comparisons .....	3 - 11
3.5	Parameter Comparisons .....	3 - 12
3.5.1	Parameter comparisons .....	3 - 12
3.5.2	Parameter change example .....	3 - 13
3.6	Program Comparisons .....	3 - 23
3.6.1	Comparison of special relays M (SB) and special registers D (SW) .....	3 - 23
3.6.2	Transient instructions .....	3 - 27
3.7	Replacement Precautions .....	3 - 28

---

## CHAPTER 4 REPLACEMENT OF THE MELSECNET/10 (PLC TO PLC NETWORK)

4 - 1 to 4 - 25

4.1	List of MELSECNET/10 Alternative Models .....	4 - 1
4.2	Specifications Comparisons .....	4 - 2
4.2.1	Module performance comparisons incompatible .....	4 - 2
4.2.2	Cable performance comparisons .....	4 - 8
4.3	Functional Comparisons .....	4 - 10
4.4	Switch Settings Comparisons .....	4 - 14
4.5	Parameter Comparisons .....	4 - 15
4.6	Program Comparisons .....	4 - 18
4.6.1	Comparison of link special relay (SB)/link special register (SW) .....	4 - 18
4.6.2	Comparison of dedicated instructions .....	4 - 21
4.7	Other Precautions .....	4 - 25

---

## CHAPTER 5 REPLACEMENT OF THE MELSECNET/10 (REMOTE I/O NETWORK)

5 - 1 to 5 - 47

5.1	Replacing MELSECNET/10 with MELSECNET/H .....	5 - 1
5.1.1	List of MELSECNET/10 alternative models .....	5 - 1
5.1.2	Specifications comparisons .....	5 - 3
5.1.3	Functional Comparisons .....	5 - 18
5.1.4	Switch setting comparisons .....	5 - 22
5.1.5	Parameter comparisons .....	5 - 24
5.1.6	Program comparisons .....	5 - 29
5.1.7	Comparison of dedicated instruction .....	5 - 30
5.1.8	Other precautions .....	5 - 35
5.2	Gradually replacing A series remote I/O stations with Q series remote I/O stations .....	5 - 36
5.2.1	List of MELSECNET/10 modules and the alternative modules .....	5 - 36
5.2.2	Module performance specifications comparisons .....	5 - 38
5.2.3	Functional comparisons .....	5 - 41
5.2.4	Switch setting comparisons .....	5 - 42
5.2.5	Parameter comparisons .....	5 - 43
5.2.6	Program comparisons .....	5 - 44
5.2.7	Last stage of the replacement .....	5 - 47

**CHAPTER 6 REPLACEMENT OF CC-LINK****6 - 1 to 6 - 27**

6.1	List of CC-Link Alternative Models .....	6 - 1
6.2	Specifications Comparisons .....	6 - 2
6.2.1	Module specifications comparisons .....	6 - 2
6.2.2	Cable performance comparisons .....	6 - 4
6.3	Functional Comparisons .....	6 - 5
6.4	Switch Settings Comparisons .....	6 - 9
6.5	Parameter Comparisons .....	6 - 11
6.6	Program Comparisons .....	6 - 12
6.6.1	Comparison of I/O signals .....	6 - 12
6.6.2	Buffer memory comparisons .....	6 - 16
6.6.3	Comparison of link special relay (SB)/link special register (SW) .....	6 - 18
6.7	Other Precautions .....	6 - 24
6.8	Parameter Setting Example .....	6 - 25
6.8.1	Parameter setting example on the A/AnS series .....	6 - 25
6.8.2	Parameter setting example on the Q series .....	6 - 27

**APPENDICES****APPX - 1 to APPX - 32**

Appendix 1	External Dimensions .....	APPX - 1
Appendix 2	Spare parts storage .....	APPX - 1
Appendix 3	Replacement using spare parts .....	APPX - 3
Appendix 3.1	Replacement using A/AnS/QnA/QnAS series MELSECNET/10 network modules .....	APPX - 3
Appendix 3.2	Replacement using MELSECNET local station data link modules .....	APPX - 17
Appendix 4	Related Manuals .....	APPX - 31
Appendix 4.1	Replacement handbooks .....	APPX - 31
Appendix 4.2	A/AnS series .....	APPX - 32
Appendix 4.3	QnA/QnAS series .....	APPX - 32
Appendix 4.4	Q series .....	APPX - 32

- For the products shown in handbooks for transition, catalogues, and transition examples, refer to the manuals for the relevant products and check the detailed specifications, precautions for use, and restrictions before replacement.

For the products manufactured by Mitsubishi Electric Engineering Co., Ltd., Mitsubishi Electric System & Service Co., Ltd., and other companies, refer to the catalogue for each product and check the detailed specifications, precautions for use, and restrictions before use.

The manuals and catalogues for our products, products manufactured by Mitsubishi Electric Engineering Co., Ltd., and Mitsubishi Electric System & Service Co., Ltd. are shown in Appendix of each handbook for transition.

- Products shown in this handbook are subject to change without notice.













## GENERIC TERMS AND ABBREVIATIONS

Unless otherwise specified, this handbook uses the following generic terms and abbreviations.

Generic term/abbreviation	Description
<b>■ Series</b>	
A series	Abbreviation for large types of Mitsubishi Electric MELSEC-A series programmable controllers
AnS series	Abbreviation for compact types of Mitsubishi Electric MELSEC-A series programmable controllers
A/AnS series	Generic term for A series and AnS series
QnA series	Abbreviation for large types of Mitsubishi Electric MELSEC-QnA series programmable controllers
QnAS series	Abbreviation for compact types of Mitsubishi Electric MELSEC-QnA series programmable controllers
QnA/QnAS series	Generic term for QnA series and QnAS series
A/AnS/QnA/QnAS series	Generic term for A series, AnS series, QnA series, and QnAS series
Q series	Abbreviation for Mitsubishi Electric MELSEC-Q series programmable controllers
<b>■ CPU module type</b>	
CPU module	Generic term for A series, AnS series, QnA series, QnAS series, and Q series CPU modules
Process CPU	Generic term for the Q02PHCPU, Q06PHCPU, Q12PHCPU, and Q25PHCPU
Redundant CPU	Generic term for the Q12PRHCPU and Q25PRHCPU
Universal model QCPU	Generic term for the Q00UJCPU, Q00UCPU, Q01UCPU, Q02UCPU, Q03UDCPU, Q03UDVCPU, Q03UDECPU, Q04UDHCPU, Q04UDVCPU, Q04UDEHCPU, Q06UDHCPU, Q06UDVCPU, Q06UDEHCPU, Q10UDHCPU, Q10UDEHCPU, Q13UDHCPU, Q13UDVCPU, Q13UDEHCPU, Q20UDHCPU, Q20UDEHCPU, Q26UDHCPU, Q26UDVCPU, and Q26UDEHCPU
<b>■ CPU module model</b>	
ACPU	Generic term for MELSEC-A series programmable controller CPUs
AnSCPU	Generic term for MELSEC-AnS series programmable controller CPUs
A/AnSCPU	Generic term for MELSEC-A series and MELSEC-AnS series programmable controller CPUs
AnNCP	Generic term for the A1NCP, A1NCPUP21/R21, A1NCPUP21-S3, A2NCP, A2NCP-S1, A2NCPUP21/R21, A2NCPUP21/R21-S1, A2NCPUP21-S3(S4), A3NCP, A3NCPUP21/R21, and A3NCPUP21-S3
AnACPU	Generic term for the A2ACPU, A2ACPU-S1, A3ACPU, A2ACPU21/R21, A2ACPU21/R21-S1, and A3ACPU21/R21
AnUCPU	Generic term for the A2UCPU, A2UCPU-S1, A3UCPU, A4UCPU, A2USCPU, A2USCPU-S1, and A2USHCPU-S1
AnN/AnACPU	Generic term for the AnNCP and AnACPU
AnN/AnA/AnSCPU	Generic term for the AnNCP, AnACPU, and AnSCPU
QnACPU	Generic term for MELSEC-QnA series programmable controller CPUs
QnASCPU	Generic term for MELSEC-QnAS series programmable controller CPUs
QnA/QnASCPU	Generic term for MELSEC-QnA series and MELSEC-QnAS series programmable controller CPUs
A/AnS/QnA/QnASCPU	Generic term for A series, AnS series, QnA series, and QnAS series programmable controller CPUs
QCPU	Generic term for MELSEC-Q series programmable controller CPUs

[About symbols used in figures]

MELSECNET( II )	MELSECNET/H
<p>   Master station             Local station    Remote I/O station            □ stands for the station No.         </p>	<p>  Control station            Normal station   Remote master station            Remote I/O station            ■ stands for the network No., and            □ stands for the station No.         </p>

# 1 INTRODUCTION

## 1.1 Transition from MELSECNET (II) and /B to MELSECNET/H

To replace the MELSECNET (II) and /B system with the Q series system, replace it with the MELSECNET/H system.

For a replacement method, refer to Appendix 3.

The following shows the configuration of the Q series MELSECNET/H system after the transition and the system configuration precautions at transition for each of the MELSECNET (II) and /B system configurations.

For details, refer to CHAPTER 2 and CHAPTER 3.

Network type	2-tier/3-tier	Component stations	Refer to
Optical loop	2-tier system	Local station only	Section 1.1 (1) (a)
		Remote I/O station only	Section 1.1 (1) (b)
		Mixture of local station and remote I/O station	Section 1.1 (1) (c)
	3-tier system	Local station only	Section 1.1 (1) (d)
		2-tier local station, 3-tier remote I/O station	Section 1.1 (1) (e)
		Mixture of local station and remote I/O station	Section 1.1 (1) (f)
Coaxial loop	2-tier system	Local station only	Section 1.1 (2) (a)
		Remote I/O station only	Section 1.1 (2) (b)
		Mixture of local station and remote I/O station	Section 1.1 (2) (c)
	3-tier system	Local station only	Section 1.1 (2) (d)
		2-tier local station, 3-tier remote I/O station	Section 1.1 (2) (e)
		Mixture of local station and remote I/O station	Section 1.1 (2) (f)
Twisted pair	2-tier system	Local station only	Section 1.1 (3) (a)
		Remote I/O station only	Section 1.1 (3) (b)
		Mixture of local station and remote I/O station	Section 1.1 (3) (c)
	3-tier system	Local station only	Section 1.1 (3) (d)
		2-tier local station, 3-tier remote I/O station	Section 1.1 (3) (e)
		Mixture of local station and remote I/O station	Section 1.1 (3) (f)

### (1) Optical cable system

#### (a) 2-tier system 1: System configuration example using local stations only

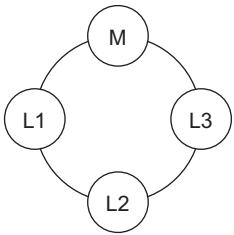
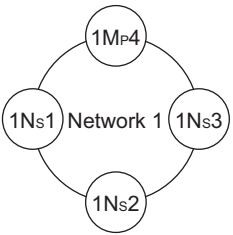
MELSECNET (II)	MELSECNET/H	System configuration precautions
<p>Optical loop</p> 	<p>Optical loop</p> 	<ol style="list-style-type: none"> <li>1) Distance between stations: If this value exceed the Q series specification values when re-using the MELSECNET(II) system cables, optical cables, etc. has to be changed.<sup>*1</sup></li> <li>2) CPU: When replacing from an integrated type CPU, one new slot (32 points) is required.</li> <li>3) Number of stations: When 65 modules are connected, measures (e.g. dividing into two networks of 64 modules or less having a different network No.) are required.</li> </ol>

\*1 As the transmission speed of MELSECNET/H is faster than that of MELSECNET(II), the distance between stations may become shorter.

#### (b) 2-tier system 2: System configuration example using remote I/O stations only

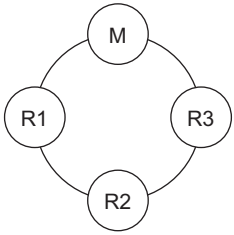
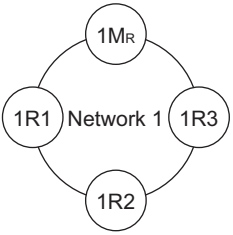
MELSECNET (II)	MELSECNET/H	System configuration precautions
<p>Optical loop</p> 	<p>Optical loop</p> 	<ol style="list-style-type: none"> <li>1) Distance between stations: If this value exceed the Q series specification values when re-using the MELSECNET(II) system cables, optical cables, etc. has to be changed.<sup>*1</sup></li> <li>2) CPU: When replacing from an integrated type CPU, one new slot (32 points) is required.</li> </ol>

\*1 As the transmission speed of MELSECNET/H is faster than that of MELSECNET(II), the distance between stations may become shorter.

### (c) 2-tier system 3: System configuration example using local stations/remote I/O stations

MELSECNET( II )	MELSECNET/H	System configuration precautions
<p>Optical loop</p>	<p>Optical loop</p>	<ol style="list-style-type: none"> <li>Distance between stations: If this value exceed the Q series specification values when re-using the MELSECNET(II) system cables, optical cables, etc. has to be changed.*<sup>1</sup></li> <li>CPU: When replacing from an integrated type CPU, one new slot (32 points) is required.</li> <li>Composite system: As a mixture of a PLC to PLC network and a remote I/O network is not allowed on the Q series, the network has to be divided into two networks having different network Nos. For this reason, a separate network module for the remote master station is required.</li> <li>New installation: A separate optical cable is required for the remote I/O stations.</li> </ol>

\*1 As the transmission speed of MELSECNET/H is faster than that of MELSECNET(II), the distance between stations may become shorter.

### (d) 3-tier system 1: System configuration example using local stations only

MELSECNET( II )	MELSECNET/H	System configuration precautions
<p>Optical loop</p>	<p>Optical loop</p>	<ol style="list-style-type: none"> <li>Distance between stations: If this value exceed the Q series specification values when re-using the MELSECNET(II) system cables, optical cables, etc. has to be changed.*<sup>1</sup></li> <li>CPU: When replacing from an integrated type CPU, one new slot (32 points) is required.</li> <li>Number of stations: When 65 modules are connected, measures (e.g. dividing into two networks of 64 modules or less having a different network No.) are required.</li> </ol>

\*1 As the transmission speed of MELSECNET/H is faster than that of MELSECNET(II), the distance between stations may become shorter.

### (e) 3-tier system 2: System configuration example using 2-tier local stations and 3-tier remote I/O stations

MELSECNET(II)	MELSECNET/H	System configuration precautions
<p>Optical loop</p>	<p>Optical loop</p>	<ol style="list-style-type: none"> <li>Distance between stations: If this value exceed the Q series specification values when re-using the MELSECNET(II) system cables, optical cables, etc. has to be changed.*1</li> <li>CPU: When replacing from an integrated type CPU, one new slot (32 points) is required.</li> <li>Number of stations: When 65 modules are connected, measures (e.g. dividing into two networks of 64 modules or less having a different network No.) are required.</li> </ol>

\*1 As the transmission speed of MELSECNET/H is faster than that of MELSECNET(II), the distance between stations may become shorter.

### (f) 3-tier system 3: System configuration example using local stations/remote I/O stations

MELSECNET(II)	MELSECNET/H	System configuration precautions
<p>Optical loop</p>	<p>Optical loop</p>	<ol style="list-style-type: none"> <li>Distance between stations: If this value exceed the Q series specification values when re-using the MELSECNET(II) system cables, optical cables, etc. has to be changed.*1</li> <li>CPU: When replacing from an integrated type CPU, one new slot (32 points) is required.</li> <li>Composite system: As a mixture of a PLC to PLC network and a remote I/O network is not allowed on the Q series, the network has to be divided into two networks having different network Nos. For this reason, a separate network module for the remote master station is required.</li> <li>New installation: A separate optical cable is required for the remote I/O stations.</li> </ol>

\*1 As the transmission speed of MELSECNET/H is faster than that of MELSECNET(II), the distance between stations may become shorter.

### (2) Coaxial cable system

#### (a) 2-tier system 1: System configuration example using local stations only

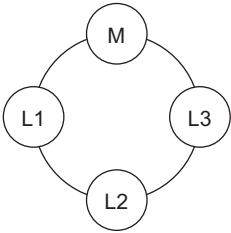
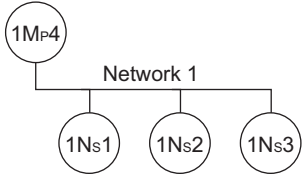
MELSECNET( II )	MELSECNET/H	System configuration precautions
<p>Coaxial loop</p> 	<p>Coaxial bus</p> 	<ol style="list-style-type: none"> <li>Distance between stations: If this value exceed the Q series specification values when re-using the MELSECNET(II) system cables, 3C-2V has to be changed to 5C-2V.*1</li> <li>Overall distance: If this value exceeds the Q series specification value when MELSECNET(II) system cables are re-used, measures (e.g. adding a repeater unit) are required.*1</li> <li>CPU: When replacing an integrated type CPU, one new slot (32 points) is required.</li> <li>Number of stations: When 65 modules are connected, measures (e.g. dividing into two or three networks of 32 modules or less having a different network No.) are required.</li> <li>Duplex loop: When the transmission path has to be duplexed, changes to an optical loop system, etc. are required.</li> </ol>

\*1 As the transmission speed of MELSECNET/H is faster than MELSECNET(II), and as the transmission method is different, the distance between stations and overall distance become shorter.

#### (b) 2-tier system 2: System configuration example using local stations only

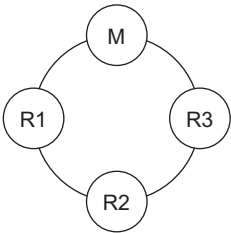
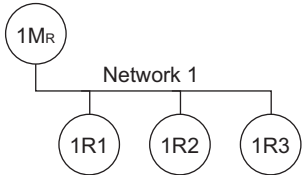
MELSECNET( II )	MELSECNET/H	System configuration precautions
<p>Coaxial loop</p> 	<p>Coaxial bus</p> 	<ol style="list-style-type: none"> <li>Distance between stations: If this value exceed the Q series specification values when re-using the MELSECNET(II) system cables, 3C-2V has to be changed to 5C-2V.*1</li> <li>Overall distance: If this value exceeds the Q series specification value when MELSECNET(II) system cables are re-used, measures (e.g. adding a repeater unit) are required.*1</li> <li>CPU: When replacing an integrated type CPU, one new slot (32 points) is required.</li> <li>Number of stations: When 65 modules are connected, measures (e.g. dividing into two or three networks of 32 modules or less having a different network No.) are required.</li> <li>Duplex loop: When the transmission path has to be duplexed, changes to an optical loop system, etc. are required.</li> </ol>

\*1 As the transmission speed of MELSECNET/H is faster than MELSECNET(II), and as the transmission method is different, the distance between stations and overall distance become shorter.

### (c) 2-tier system 3: System configuration example using local stations/remote I/O stations

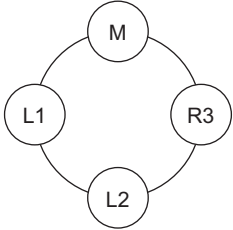
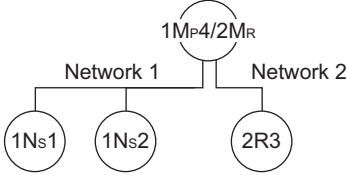
MELSECNET(II)	MELSECNET/H	System configuration precautions
<p>Coaxial loop</p> 	<p>Coaxial bus</p> 	<ol style="list-style-type: none"> <li>1) Distance between stations: If this value exceed the Q series specification values when re-using the MELSECNET(II) system cables, 3C-2V has to be changed to 5C-2V.*1</li> <li>2) Overall distance: If this value exceeds the Q series specification value when MELSECNET(II) system cables are re-used, measures (e.g. adding a repeater unit) are required.*1</li> <li>3) CPU: When replacing an integrated type CPU, one new slot (32 points) is required.</li> <li>4) Duplex loop: When the transmission path has to be duplexed, changes to an optical loop system, etc. are required.</li> <li>5) Composite system: As a mixture of a PLC to PLC network and a remote I/O network is not allowed on the Q series, the network has to be divided into two networks having different network Nos. For this reason, a separate network module for the remote master station is required.</li> <li>6) New installation: A separate coaxial cable is required for the remote I/O stations.</li> </ol>

\*1 As the transmission speed of MELSECNET/H is faster than MELSECNET(II), and as the transmission method is different, the distance between stations and overall distance become shorter.

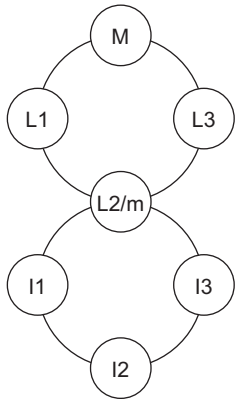
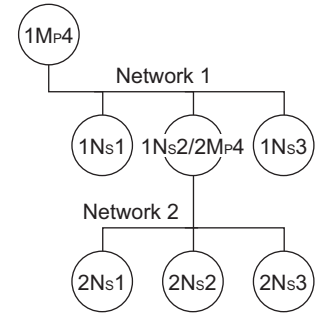

(d) 3-tier system 1: System configuration example using local stations only

MELSECNET(II)	MELSECNET/H	System configuration precautions
<p>Coaxial loop</p> 	<p>Coaxial bus</p> 	<ol style="list-style-type: none"> <li>Distance between stations: If this value exceed the Q series specification values when re-using the MELSECNET(II) system cables, 3C-2V has to be changed to 5C-2V.*1</li> <li>Overall distance: If this value exceeds the Q series specification value when MELSECNET(II) system cables are re-used, measures (e.g. adding a repeater unit) are required.*1</li> <li>CPU: When replacing an integrated type CPU, one new slot (32 points) is required.</li> <li>Number of stations: When 65 modules are connected, measures (e.g. dividing into two or three networks of 32 modules or less having a different network No.) are required.</li> <li>Duplex loop: When the transmission path has to be duplexed, changes to an optical loop system, etc. are required.</li> </ol>

\*1 As the transmission speed of MELSECNET/H is faster than MELSECNET(II), and as the transmission method is different, the distance between stations and overall distance become shorter.

(e) 3-tier system 2: System configuration example using 2-tier local stations and 3-tier remote I/O stations

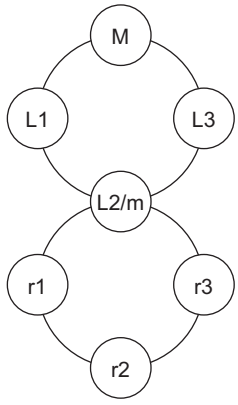
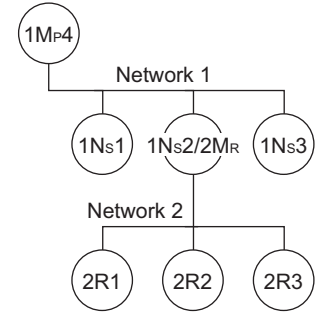
MELSECNET(II)	MELSECNET/H	System configuration precautions
<p>Coaxial loop</p> 	<p>Coaxial bus</p> 	<ol style="list-style-type: none"> <li>Distance between stations: If this value exceed the Q series specification values when re-using the MELSECNET(II) system cables, 3C-2V has to be changed to 5C-2V.*1</li> <li>Overall distance: If this value exceeds the Q series specification value when MELSECNET(II) system cables are re-used, measures (e.g. adding a repeater unit) are required.*1</li> <li>CPU: When replacing an integrated type CPU, one new slot (32 points) is required.</li> <li>Number of stations: When 65 modules are connected, measures (e.g. dividing into two or three networks of 32 modules or less having a different network No.) are required.</li> <li>Duplex loop: When the transmission path has to be duplexed, changes to an optical loop system, etc. are required.</li> </ol>

\*1 As the transmission speed of MELSECNET/H is faster than MELSECNET(II), and as the transmission method is different, the distance between stations and overall distance become shorter.

### (f) 3-tier system 3: System configuration example using local stations/remote I/O stations

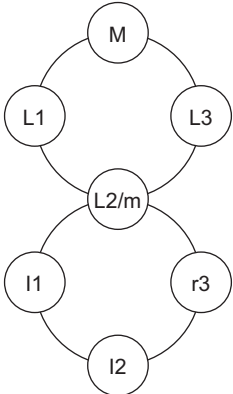
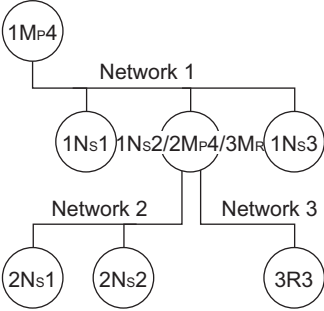
MELSECNET(II)	MELSECNET/H	System configuration precautions
<p>Coaxial loop</p> 	<p>Coaxial bus</p> 	<ol style="list-style-type: none"> <li>1) Distance between stations: If this value exceed the Q series specification values when re-using the MELSECNET(II) system cables, 3C-2V has to be changed to 5C-2V.*1</li> <li>2) Overall distance: If this value exceeds the Q series specification value when MELSECNET(II) system cables are re-used, measures (e.g. adding a repeater unit) are required.*1</li> <li>3) CPU: When replacing an integrated type CPU, one new slot (32 points) is required.</li> <li>4) Duplex loop: When the transmission path has to be duplexed, changes to an optical loop system, etc. are required.</li> <li>5) Composite system: As a mixture of a PLC to PLC network and a remote I/O network is not allowed on the Q series, the network has to be divided into two networks having different network Nos. For this reason, a separate network module for the remote master station is required.</li> <li>6) New installation: A separate coaxial cable is required for the remote I/O stations.</li> </ol>

\*1 As the transmission speed of MELSECNET/H is faster than MELSECNET(II), and as the transmission method is different, the distance between stations and overall distance become shorter.

### (3) Twisted cable system

#### (a) 2-tier system 1: System configuration example using local stations only

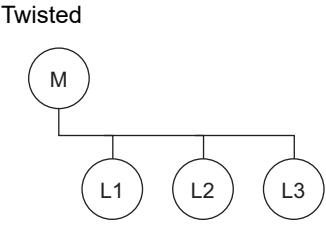
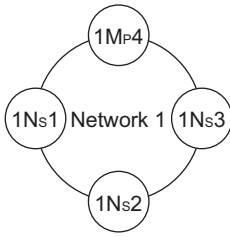
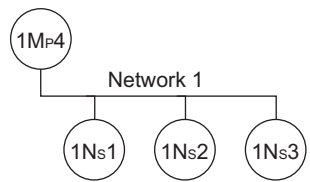
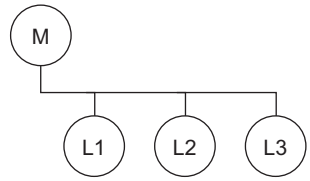
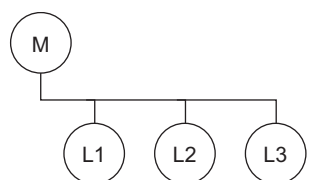
MELSECNET/B	MELSECNET/H	System configuration precautions
<p>Twisted</p> 	<p>Optical loop</p> 	<p>New installation: The installation has to be changed for an optical loop system or a coaxial bus system.</p>
	<p>Coaxial bus</p> 	
	<p>Twisted cables (using existing cables)</p> 	<p>Existing cables: Process the terminals for MELSECNET/H connection.</p>
	<p>Twisted cables (using CC-Link dedicated cables)</p> 	<p>New installation: Change the cables to CC-Link dedicated cables.</p>

#### (b) 2-tier system 2: System configuration example using remote I/O stations only

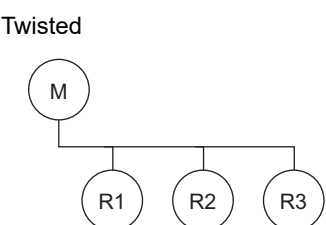
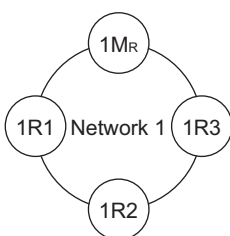
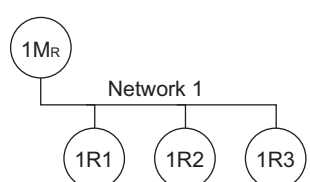
MELSECNET/B	MELSECNET/H	System configuration precautions
<p>Twisted</p> 	<p>Optical loop</p> 	<p>1) New installation: The installation has to be changed for an optical loop system or a coaxial bus system.</p> <p>2) Wire-saving: Changing to a wire-saving network by using CC-Link or CC-Link/LT is also recommended.</p>
	<p>Coaxial bus</p> 	

### (c) 2-tier system 3: System configuration example using local stations/remote I/O stations

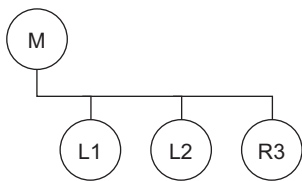
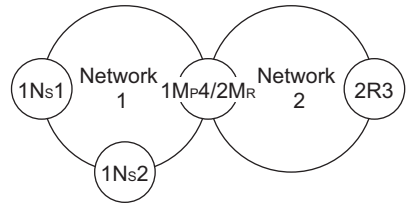
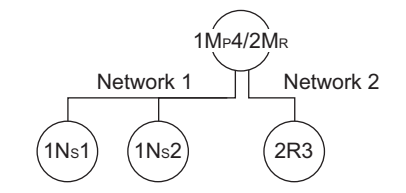
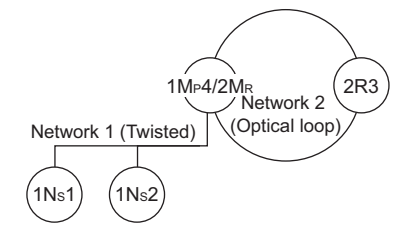
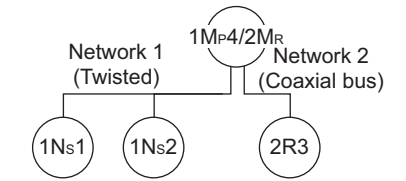
MELSECNET/B	MELSECNET/H	System configuration precautions
<p>Twisted</p> 	<p>Optical loop</p> 	<ol style="list-style-type: none"> <li>1) New installation: The installation has to be changed for an optical loop system or a coaxial bus system.</li> <li>2) Composite system: As a mixture of a PLC to PLC network and a remote I/O network is not allowed on the Q series, the network has to be divided into two networks having different network Nos. For this reason, a separate network module for the remote master station is required.</li> <li>3) Wire-saving: Changing to a wire-saving network by using CC-Link or CC-Link/LT is also recommended for remote I/O stations.</li> </ol>
	<p>Coaxial bus</p> 	
	<p>Twisted/Optical loop</p> 	
	<p>Twisted/Coaxial bus</p> 	

### (d) 3-tier system 1: System configuration example using local stations only

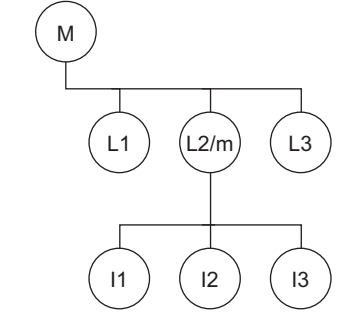
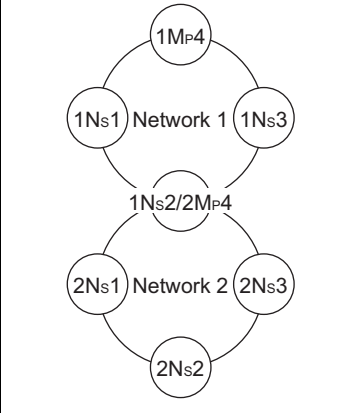
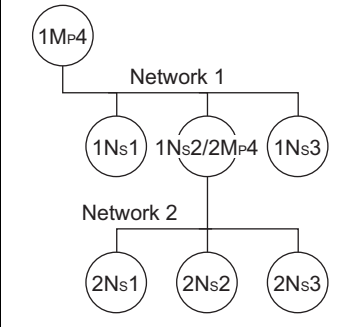
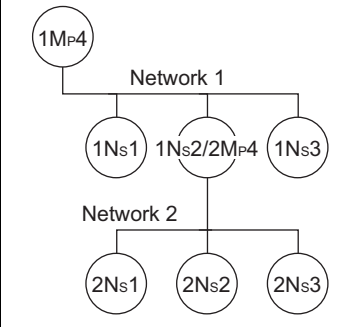
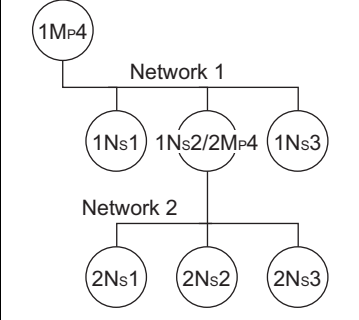
MELSECNET/B	MELSECNET/H	System configuration precautions
<p>Twisted</p> 	<p>Optical loop</p> 	<p>New installation: The installation has to be changed for an optical loop system or a coaxial bus system.</p>
	<p>Coaxial bus</p> 	
	<p>Twisted (using existing cables)</p> 	<p>Existing cables: Process the terminals for MELSECNET/H connection.</p>
	<p>Twisted (using CC-Link dedicated cables)</p> 	<p>New installation: Change the cables to CC-Link dedicated cables.</p>

**(e) 3-tier system 2: System configuration example using 2-tier local stations and 3-tier remote I/O stations**

MELSECNET/B	MELSECNET/H	System configuration precautions
<p>Twisted</p>	<p>Optical loop</p>	<p>New installation: The installation has to be changed for an optical loop system or a coaxial bus system.</p> <p>A PLC to PLC network can be changed to a twisted bus system, and a remote I/O network can be changed to an optical loop or coaxial bus system (refer to (c)).</p>
	<p>Coaxial bus</p>	

**(f) 3-tier system 3: System configuration example using local stations/remote I/O stations**

MELSECNET/B	MELSECNET/H	System configuration precautions
<p>Twisted</p>	<p>Optical loop</p>	<ol style="list-style-type: none"> <li>1) New installation: The installation has to be changed for an optical loop system or a coaxial bus system. A PLC to PLC network can be changed to a twisted bus system, and a remote I/O network can be changed to an optical loop or coaxial bus system (refer to (c)). By processing the terminals, the existing cables can be used for the twisted bus system.</li> <li>2) Composite system: As a mixture of a PLC to PLC network and a remote I/O network is not allowed on the Q series, the network has to be divided into two networks having different network Nos. For this reason, a separate network module for the remote master station is required.</li> <li>3) Wire-saving: Changing to a wire-saving network by using CC-Link or CC-Link/LT is also recommended for remote I/O stations.</li> </ol>
	<p>Coaxial bus</p>	

## 1.2 Replacement of the MELSECNET/10 for A/AnS/QnA/QnAS Series with the MELSECNET/H for Q Series

The following shows the configuration of a MELSECNET/H network system for Q after transition and the system configuration precautions for transition for each of the system configurations for MELSECNET/10 network systems for A/AnS/QnA/QnAS series.

For details, refer to CHAPTER 4 REPLACEMENT OF THE MELSECNET/10 (PLC TO PLC NETWORK) and CHAPTER 5 REPLACEMENT OF THE MELSECNET/10(REMOTE I/O NETWORK).

### (1) PLC to PLC network

Pay attention to the following common precautions when replacing PLC to PLC networks.

#### Common precautions

- 1) Network parameters must be set for MELSECNET/H module of normal stations.  
When replacing MELSECNET/10 module mounted on the CPU module of the AnN/AnA/AnSCPU (excluding AnUS(H)CPU), newly set network parameters.

#### (a) Optical loop system

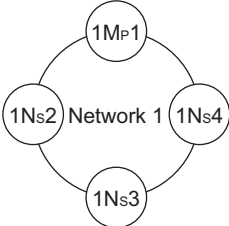
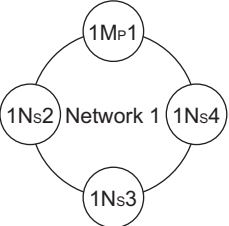
MELSECNET/10	MELSECNET/H	System configuration precautions
Optical loop 	Optical loop 	The following item is provided in addition to common precautions (1) above. <ul style="list-style-type: none"> <li>• When mixing with MELSECNET/10 modules for A/AnS/QnA/QnAS series, set the MELSECNET/10 mode (control station) or MELSECNET/10 mode (normal station) as the network type.</li> </ul>

#### (b) Coaxial bus system

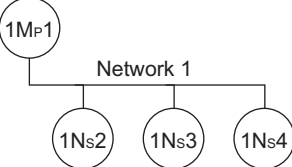
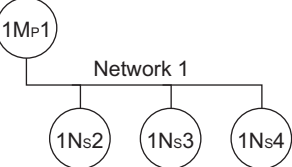
MELSECNET/10	MELSECNET/H	System configuration precautions
Coaxial bus 	Coaxial bus 	The following item is provided in addition to common precautions (1) above. <ul style="list-style-type: none"> <li>• When mixing with MELSECNET/10 modules for A/AnS/QnA/QnAS series, set the MELSECNET/10 mode (control station) or MELSECNET/10 mode (normal station) as the network type.</li> </ul>

### (c) Coaxial loop system

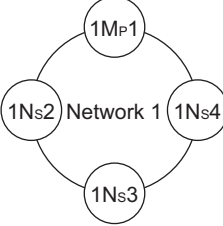
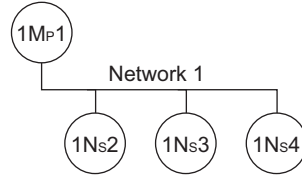
MELSECNET/10	MELSECNET/H	System configuration precautions
<p>Coaxial loop</p> 	<p>Coaxial bus</p> 	<p>The following item is provided in addition to common precautions (1) described on the previous page.</p> <ul style="list-style-type: none"> <li>• Overall distance: If this value exceeds the Q series specification value when the MELSECNET/10 system cables are re-used, measures (e.g. adding a repeater unit) are required.</li> <li>• Number of stations: When 64 modules are connected, measures (e.g. dividing into two or three networks of 32 modules or less having a different network No.) are required.</li> <li>• Duplex loop: When the transmission path has to be duplexed, changes to an optical loop system, etc. are required.</li> </ul>

## (2) Remote I/O network

Pay attention to the following common precautions when replacing remote I/O networks.

### Common precautions

- 1) Modules for remote I/O of the CPU module on each master station
  - (a) When the Q series CPU module on the master station is used
 

On the remote I/O network, the MELSECNET/H module and MELSECNET/10 module for A/AnS/QnA/QnAS series cannot be used in combination. When the master station is replaced with the Q series modules, replace all remote I/O station with the MELSECNET/H module for the Q series.
  - (b) When the AnU(S)/QnA(S) series CPU module on the master station is used
 

On the remote I/O network, the MELSECNET/H module for the Q series and MELSECNET/10 module for the A/AnS/QnA/QnAS series can be used in combination using MELSECNET/10 mode.

○: Connection allowed, ×: Connection not allowed

Remote I/O station	MELSECNET/10 module for A/AnS/QnA/QnAS series	MELSECNET/H module for Q series
Remote master station AnU(S)/QnA(S)CPU + MELSECNET/10 module for A/AnS/QnA/QnAS series	○	○ <sup>*1</sup> (MELSECNET/10 mode)
Q series CPU module + MELSECNET/H module for Q series	×	○ (MELSECNET/H mode)

\*1 Modules with a serial number (first five digits) of "15012" or later

- 1) When replacing a multiplex master system, select Q12PHCPU, Q25PHCPU, Q12PRHCPU, or Q25PRHCPU as the CPU module.
- 2) When replacing a parallel master system, build a separate network having a different network No.



### (a) Optical loop system

- When the master station is replaced

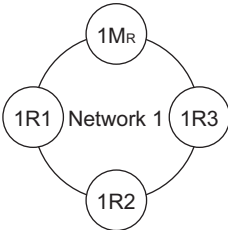
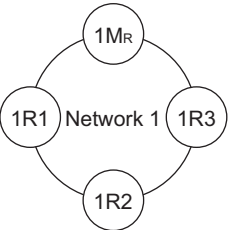
MELSECNET/10	MELSECNET/H	System configuration precautions
<p>Optical loop</p> 	<p>Optical loop</p> 	<p>The module configuration example when the master station is replaced            1M<sub>R</sub>: QCPU + QJ71LP21-25            1R1 to 1R3:            QJ72LP25-25 (MELSECNET/H mode)</p>

- When the module is replaced gradually

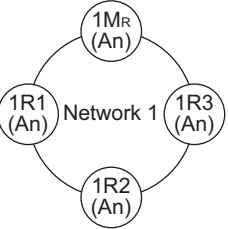
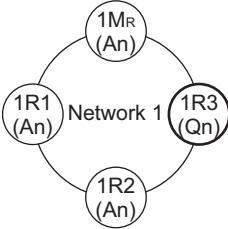
MELSECNET/10	MELSECNET/10	System configuration precautions
<p>Optical loop</p> 	<p>Optical loop</p> 	<p>The example when the module is replaced gradually            (1R3 is replaced with the Q series module)            1R3: A(1S)J72(Q)LP25 → QJ72LP25-25            (MELSECNET/10 mode)</p>

### (b) Coaxial bus system

- When the master station is replaced

MELSECNET/10	MELSECNET/H	System configuration precautions
<p>Coaxial bus</p>	<p>Coaxial bus</p>	<p>The module configuration example when the master station is replaced            1MR: QCPU + QJ71BR11            1R1 to 1R3: QJ72BR15 (MELSECNET/H mode)</p>

- When the module is replaced gradually

MELSECNET/10	MELSECNET/10	System configuration precautions
<p>Coaxial bus</p>	<p>Coaxial bus</p>	<p>The example when the module is replaced gradually            (1R3 is replaced with the Q series module)            1R3: A(1S)J72(Q)BR15 → QJ72BR15            (MELSECNET/10 mode)</p>

### (c) Coaxial loop system

MELSECNET/10	MELSECNET/H	System configuration precautions
<p>Coaxial loop</p>	<p>Coaxial bus</p>	<ul style="list-style-type: none"> <li>• The Q series modules do not support the coaxial loop system. When the existing system is replaced with the coaxial loop system, replace all remote I/O stations.</li> <li>• Overall distance: If this value exceeds the Q series specification value when the MELSECNET/10 system cables are re-used, measures (e.g. adding a repeater unit) are required.</li> <li>• Number of stations: When 64 modules are connected, measures (e.g. dividing into two or three networks of 32 modules or less having a different network No.) are required.</li> <li>• Duplex loop: When the transmission path has to be duplexed, changes to an optical loop system, etc. are required.</li> </ul>

### 1.3 Replacing the CC-Link for A/AnS/QnA/QnAS Series with the CC-Link for Q Series

When using the A/AnS/QnA/QnAS series CC-Link system master/local module, replace it with the QJ61BT11N CC-Link system master/local module.

Currently used CC-Link dedicated cables, remote I/O stations, remote device stations, and intelligent device stations can be used excluding some models.

For details on models that cannot be used, check Section 6.7 Other Precautions.

# 2 REPLACEMENT OF MELSECNET (II) AND /B (PLC TO PLC NETWORK)

## 2.1 List of MELSECNET (II) and /B Alternative Models

### (1) Replacement of MELSECNET (II) modules with MELSECNET/H modules

Network type	A/AnS/A0J2(H) series	Alternative models for Q series
Optical loop (CPU integrated type)	A1NCPUP21	CPU module + QJ71LP21-25 (Optical loop: SI cable supported)
	A2NCPUP21	
	A2NCPUP21-S1	
	A3NCPUP21	
	A2ACPUP21	
	A2ACPUP21-S1	
	A3ACPUP21	
	A2CCPUP21	
	A0J2HCPUP21	
Optical loop (CPU integrated type)	A1NCPUP21-S3	CPU module + QJ71LP21G (Optical loop: GI cable supported)
	A2NCPUP21-S3	
	A2NCPUP21-S4	
	A3NCPUP21-S3	
	A2ACPUP21-S3	
	A2ACPUP21-S4	
	A3ACPUP21-S3	
Coaxial loop (CPU integrated type)	A1NCPUR21	CPU module + QJ71BR11 (Coaxial bus)
	A2NCPUR21	
	A2NCPUR21-S1	
	A3NCPUR21	
	A2ACPUR21	
	A2ACPUR21-S1	
	A3ACPUR21	
	A2CCPUR21	
	A0J2HCPUR21	
Optical loop (Standalone)	AJ71AP21	QJ71LP21-25 (Optical loop: SI cable supported)
	A1SJ71AP21	
Optical loop (Standalone)	AJ71AP21-S3	QJ71LP21G (Optical loop: GI cable supported)
	AJ71P22-S3 <sup>*1</sup>	
	AJ71AP22-S3 <sup>*1</sup>	
	A1SJ71AP21-S3	
Coaxial loop (Standalone)	AJ71AR21	QJ71BR11 (Coaxial bus)
	A1SJ71AR21	

\*1 These modules can be used as the master station only.

## (2) Replacement of MELSECNET/B modules with MELSECNET/H modules

Network type	A/AnS series	Alternative models for Q series
Twisted pair	AJ71AT21B	QJ71NT11B (Twisted bus) <sup>*1</sup>
	A1SJ71AT21B	QJ71LP21-25 (Optical loop: SI cable supported) QJ71BR11 (Coaxial bus)

\*1 Supported by the QCPU only. A system including an A/AnS/QnA/QnAS series module cannot be configured.  
The twisted bus system can be employed for a PLC to PLC network, but not for a remote I/O network.

## 2.2 Specifications Comparisons

### 2.2.1 Module specifications comparisons

#### (1) Comparison between MELSECNET (II) module (optical loop) and MELSECNET/H module (optical loop)

##### (a) SI optical fiber cable, H-PCF optical fiber cable

○: Compatible, △: Partial change required, ×: Incompatible

Item	Specifications		Compat- ibility	Precautions for replacement	
	MELSECNET (II) module	MELSECNET/H module			
	Optical loop	Optical loop (QJ71LP21-25)			
Maximum number of link points per network	X/Y	Max. 2048 points and max. number of I/O points of CPU module on master station	(MELSECNET/10 mode), (MELSECNET/H mode), (MELSECNET/H extended mode) 8192 points	○	
	B	• (MELSECNET mode) 1024 points • (MELSECNET II mode), (MELSECNET II composite mode) 4096 points	• (MELSECNET/10 mode) 8192 points • (MELSECNET/H mode), (MELSECNET/H extended mode) 16384 points	○	
	W	• (MELSECNET mode) 1024 points • (MELSECNET II mode), (MELSECNET II composite mode) 4096 points	• (MELSECNET/10 mode) 8192 points • (MELSECNET/H mode), (MELSECNET/H extended mode) 16384 points	○	
Maximum number of link points per station	• (MELSECNET mode) 1024 bytes • (MELSECNET II mode), (MELSECNET II composite mode) First half: 1024 bytes Second half: 1024 bytes	• (MELSECNET/10 mode), (MELSECNET/H mode) $\{(LY+LB) \div 8 + (2 \times LW)\} \leq 2000$ bytes • (MELSECNET/H extended mode) $\{(LY + LB) \div 8 + (2 \times LW)\} \leq 35840$ bytes	△	When the number of bytes exceeds 2000, mount two modules having the same network No., or set all modules on the network in the MELSECNET/H extended mode.	
Communication speed	1.25Mbps	25Mbps/10Mbps	○		
Number of stations connected in one network	65 stations (master station: 1, local station + remote I/O station: 64)	64 stations (control station: 1 normal station: 63)	△	• Set the remote I/O network to a separate network. • For the 65th station, configure a separate network.	
Applicable cable	SI optical cable H-PCF optical cable	SI optical cable H-PCF optical cable Broad-band H-PCF optical cable QSI optical cable	△	When using existing SI cables, the distance between stations may be shortened. (Refer to Section 2.2.2.)	
Overall distance	10km	30km	○		
Distance between stations	Refer to Section 2.2.2.	Refer to Section 2.2.2.	△	To ensure the same distance as before replacement, either change the optical cable, or install a gateway station midway along existing cables.	
Maximum number of networks	-	239	△	New MELSECNET/H parameter (mandatory)	
Communication method	Half duplex bit serial method	Token ring method	△	Nothing to be noted though the communication method differs.	
Transmission method	Duplex loop		○		
Modulation method (Encoding method)	(Modulation method) CMI method	(Encoding method) NRZI coding	△	Nothing to be noted though the modulation method differs.	
Transmission format	HDLC standards (frame format)		○		
Error control system	CRC( $X^{16}+X^{12}+X^5+1$ ) and retry by a time over		○		
RAS function	• Loop-back function due to error detection or broken cable • Diagnostic function for checking local link lines		○		
Number of occupied I/O points	CPU integrated type: 0 point, standalone:32 points per slot (I/O assignment: special 32 points)	32 points per slot (I/O assignment: intelli. 32 points)	△	When replacing from a CPU integrated type, an additional slot (32 points) is required.	

## (b) Modules for GI optical cable

○: Compatible, △: Partial change required, ×: Incompatible

Item	Specifications		Compat- ibility	Precautions for replacement	
	MELSECNET (II) module	MELSECNET/H module			
	Optical loop	Optical loop (QJ71LP21-25)			
Maximum number of link points per network	X/Y	Max. 2048 points and max. number of I/O points of CPU module on master station	(MELSECNET/10 mode), (MELSECNET/H mode), (MELSECNET/H extended mode) 8192 points	○	
	B	<ul style="list-style-type: none"> <li>• (MELSECNET mode) 1024 points</li> <li>• (MELSECNET II mode), (MELSECNET II composite mode) 4096 points</li> </ul>	<ul style="list-style-type: none"> <li>• (MELSECNET/10 mode) 8192 points</li> <li>• (MELSECNET/H mode), (MELSECNET/H extended mode) 16384 points</li> </ul>	○	
	W	<ul style="list-style-type: none"> <li>• (MELSECNET mode) 1024 points</li> <li>• (MELSECNET II mode), (MELSECNET II composite mode) 4096 points</li> </ul>	<ul style="list-style-type: none"> <li>• (MELSECNET/10 mode) 8192 points</li> <li>• (MELSECNET/H mode), (MELSECNET/H extended mode) 16384 points</li> </ul>	○	
Maximum number of link points per station	<ul style="list-style-type: none"> <li>• (MELSECNET mode) 1024 bytes</li> <li>• (MELSECNET II mode), (MELSECNET II composite mode) First half: 1024 bytes Second half: 1024 bytes</li> </ul>	<ul style="list-style-type: none"> <li>• (MELSECNET/10 mode), (MELSECNET/H mode) <math>\{(LY + LB) \div 8 + (2 \times LW)\} \leq 2000</math> bytes</li> <li>• (MELSECNET/H extended mode) <math>\{(LY + LB) \div 8 + (2 \times LW)\} \leq 35840</math> bytes</li> </ul>	△	When the number of bytes exceeds 2000, mount two modules having the same network No., or set all modules on the network in the MELSECNET/H extended mode.	
Communication speed	1.25Mbps	10Mbps	○		
Number of stations connected in one network	65 stations (master station: 1, local station + remote I/O station: 64)	64 stations (control station: 1 normal station: 63)	△	<ul style="list-style-type: none"> <li>• Set the remote I/O network to a separate network.</li> <li>• For the 65th station, configure a separate network.</li> </ul>	
Applicable cable	GI optical cable		○		
Overall distance	10km	30km	○		
Distance between stations	GI optical cable: 2km		○		
Maximum number of networks	-	239	△	New MELSECNET/H parameter (mandatory)	
Communication method	Half duplex bit serial method	Token ring method	△	Nothing to be noted though the communication method differs.	
Transmission method	Duplex loop		○		
Modulation method (Encoding method)	(Modulation method) CMI method	(Encoding method) NRZI coding	△	Nothing to be noted though the modulation method differs.	
Transmission format	HDLC standards (frame format)		○		
Error control system	CRC( $X^{16}+X^{12}+X^5+1$ ) and retry by a time over		○		
RAS function	<ul style="list-style-type: none"> <li>• Loop-back function due to error detection or broken cable</li> <li>• Diagnostic function for checking local link lines</li> </ul>		○		
Number of occupied I/O points	CPU integrated type: 0 point, Standalone:32 points per slot (I/O assignment: special 32 points)	32 points per slot (I/O assignment: intelli. 32 points)	△	When replacing from a CPU integrated type, an additional slot (32 points) is required.	

## (2) Comparison between MELSECNET (II) module (coaxial loop) and MELSECNET/H module (coaxial bus)

○: Compatible, △: Partial change required, ×: Incompatible

Item	Specifications		Compat- ibility	Precautions for replacement
	MELSECNET ( II ) module	MELSECNET/H module		
	Coaxial loop	Coaxial bus (QJ71BR11)		
Maximum number of link points per network	X/Y	Max. 2048 points and max. number of I/O points of CPU module on master station	(MELSECNET/10 mode), (MELSECNET/H mode), (MELSECNET/H extended mode) 8192 points	○
	B	• (MELSECNET mode) 1024 points • (MELSECNET II mode), (MELSECNET II composite mode) 4096 points	• (MELSECNET/10 mode) 8192 points • (MELSECNET/H mode), (MELSECNET/H extended mode) 16384 points	○
	W	• (MELSECNET mode) 1024 points • (MELSECNET II mode), (MELSECNET II composite mode) 4096 points	• (MELSECNET/10 mode) 8192 points • (MELSECNET/H mode), (MELSECNET/H extended mode) 16384 points	○
Maximum number of link points per station	• (MELSECNET mode) 1024 bytes • (MELSECNET II mode), (MELSECNET II composite mode) First half: 1024 bytes Second half: 1024 bytes	• (MELSECNET/10 mode), (MELSECNET/H mode) $\{(LY + LB) \div 8 + (2 \times LW)\} \leq 2000$ bytes • (MELSECNET/H extended mode) $\{(LY + LB) \div 8 + (2 \times LW)\} \leq 35840$ bytes	△	When the number of bytes exceeds 2000, mount two modules having the same network No., or set all modules on the network in the MELSECNET/H extended mode.
Communication speed	1.25Mbps	10Mbps	○	
Number of stations connected in one network	65 stations (master station: 1, local station + remote I/O station: 64)	32 stations (control station: 1, normal station: 31)	△	• Set the remote I/O network to a separate network. • For the 33th station, configure a separate network.
Applicable cable	3C-2V 5C-2V		△	When using existing cables, the overall distance and distance between stations becomes shorter.
Overall distance	3C-2V: 10km 5C-2V: 10km	3C-2V: 300m 5C-2V: 500m	△	Either use an A6BR10/A6BR10-DC type repeater unit, or configure a separate network.
Distance between stations	3C-2V: 500m 5C-2V: 500m	3C-2V: 300m 5C-2V: 500m	△	When using the 3C-2V, use the A6BR10/A6BR10-DC type repeater unit.
Maximum number of networks	-	239	△	New MELSECNET/H parameter (mandatory)
Communication method	Half duplex bit serial method	Token ring method	△	Nothing to be noted though the communication method differs.
Transmission method	Duplex loop	Single bus	△	Nothing to be noted though the transmission method differs.
Modulation method (Encoding method)	(Modulation method) CMI method	(Encoding method) Manchester code	△	Nothing to be noted though the modulation method differs.
Transmission format	HDLC standards (frame format)		○	
Error control system	CRC( $X^{16}+X^{12}+X^5+1$ ) and retry by a time over		○	
RAS function	• Loop-back function due to error detection or broken cable • Diagnostic function for checking local link lines	Diagnostic function for checking local link lines	△	The loopback function cannot be used on a coaxial bus system. To use the loopback function, using an optical loop system is recommended.
Number of occupied I/O points	CPU integrated type: 0 point, Standalone: 32 points per slot (I/O assignment: special 32 points)	32 points per slot (I/O assignment: intelli. 32 points)	△	When replacing from a CPU integrated type, an additional slot (32 points) is required.



## (3) Comparison between MELSECNET/B module (twisted pair) and MELSECNET/H module (optical loop/coaxial bus)

○: Compatible, △: Partial change required, ×: Incompatible

Item	Specifications			Compat- ibility	Precautions for replacement
	MELSECNET/B module		MELSECNET/H module		
	Twisted pair	Optical loop (QJ71LP21-25)	Coaxial bus (QJ71BR11)		
Maximum number of link points per network	X/Y	Max. 2048 points and max. number of I/O points of CPU module on master station	(MELSECNET/10 mode), (MELSECNET/H mode), (MELSECNET/H extended mode) 8192 points	○	
	B	• (MELSECNET mode) 1024 points • (MELSECNET II mode), (MELSECNET II composite mode) 4096 points	• (MELSECNET/10 mode) 8192 points • (MELSECNET/H mode), (MELSECNET/H extended mode) 16384 points	○	
	W	• (MELSECNET mode) 1024 points • (MELSECNET II mode), (MELSECNET II composite mode) 4096 points	• (MELSECNET/10 mode) 8192 points • (MELSECNET/H mode), (MELSECNET/H extended mode) 16384 points	○	
Maximum number of link points per station		• (MELSECNET mode) 1024 bytes • (MELSECNET II mode), (MELSECNET II composite mode) Link parameter first half: 1024 bytes Link parameter second half: 1024 bytes	• (MELSECNET/10 mode), (MELSECNET/H mode) $\{(LY + LB) \div 8 + (2 \times LW)\} \leq 2000$ bytes • (MELSECNET/H extended mode) $\{(LY + LB) \div 8 + (2 \times LW)\} \leq 35840$ bytes	△	When the number of bytes exceeds 2000, mount two modules having the same network No., or set all modules on the network in the MELSECNET/H extended mode.
Communication speed	125kbps/250kbps/500kbps/1Mbps	25Mbps/10Mbps	-	○	
		-	10Mbps	○	
Number of stations connected in one network	32 stations (master station: 1, local station + remote I/O station: 31)	64 stations (control station: 1 normal station: 63)	-	△	Set the remote I/O network to a separate network.
		-	32 stations (control station: 1 normal station: 31)	△	Set the remote I/O network to a separate network.
Applicable cable	Shielded twisted pair cable	SI optical cable H-PCF optical cable Broad-band H-PCF optical cable QSI optical cable	-	△	A new optical cable has to be installed.
		-	3C-2V 5C-2V	△	A new coaxial cable has to be installed.
Overall distance	125kbps: 1200m 250kbps: 600m 500kbps: 400m 1Mbps: 200m	30km	-	○	
		-	3C-2V: 300m 5C-2V: 500m	△	Either use an A6BR10/A6BR10-DC type repeater unit, or configure a separate network.
Distance between stations	125kbps: 1200m 250kbps: 600m 500kbps: 400m 1Mbps: 200m	Refer to Section 2.2.2.	-	△	When 1200 m is required, use GI optical cables for all optical cables, and use QJ71LP21G as the module.
		-	3C-2V: 300m 5C-2V: 500m	△	Either use an A6BR10/A6BR10-DC type repeater unit, or configure a separate network.
Maximum number of networks	-	239		△	New MELSECNET/H parameter (mandatory)
Communication method	Half duplex bit serial method	Token bus method		△	Nothing to be noted though the communication method differs.
Transmission method	Single bus	Duplex loop	-	△	Nothing to be noted though the transmission method differs.
		-	Single bus	○	

Item	Specifications			Compat- ibility	Precautions for replacement
	MELSECNET/B module	MELSECNET/H module			
	Twisted pair	Optical loop (QJ71LP21-25)	Coaxial bus (QJ71BR11)		
Modulation method (Encoding method)	(Modulation method) NRZI method	(Encoding method) NRZI coding	-	○	Nothing to be noted though the modulation method differs.
		-	(Encoding method) Manchester code	△	
Transmission format	HDLC standards (frame format)			○	
Error control system	CRC( $X^{16}+X^{12}+X^5+1$ ) and retry by a time over			○	
RAS function	Diagnostic function for checking local link lines			○	
Occupied I/O points	Standalone:32 points per slot (I/O assignment: special 32 points)	32 points per slot (I/O assignment: intelli. 32 points)		○	

## 2.2.2 Cable performance comparisons

### (1) Optical fiber cable

#### (a) Overall distance

The overall distance (30km) does not differ according to the optical fiber cable.

#### (b) Distance between stations

##### 1) SI optical fiber cable

○: Compatible, △: Partial change required, ×: Incompatible

Type		MELSECNET (II) module (optical loop)	MELSECNET/H module (optical loop)		Compat- ibility	Precautions for replacement
			10Mbps	25Mbps		
SI optical fiber cable (Type: A-2P-□)	L type	1km	500m	200m	△	Refer to*1 below.
	H type	500m	300m	100m	△	
SI optical fiber cable (Type: AN-2P-□)		1km	500m	200m	△	
H-PCF optical fiber cable		1km	1km	400m	△	Refer to*2 below.
Broad-band H-PCF optical fiber cable		-	1km	1km	○	
QSI optical fiber cable		-	1km	1km	○	

\*1 When the distance between stations does not satisfy the MELSECNET/H specifications, either change the type of optical fiber cable, or install a gateway station midway along existing cables.

\*2 When the distance between stations does not satisfy the MELSECNET/H specifications, use at a communication speed of 10 Mbps, change the type of optical fiber cable, or install a gateway station midway along existing cables.

##### 2) GI optical fiber cable

○: Compatible, △: Partial change required, ×: Incompatible

Type	MELSECNET (II) module (optical loop)	MELSECNET/H module (optical loop)	Compat- ibility	Precautions for replacement
GI optical fiber cable	2km	2km	○	

### (2) Coaxial cable

#### (a) Overall distance

○: Compatible, △: Partial change required, ×: Incompatible

Type	MELSECNET (II) module (coaxial loop)	MELSECNET/H module (coaxial bus)	Compatibility	Precautions for replacement
3C-2V	10km	300m	△	Refer to*3 below.
5C-2V	10km	500m	△	

\*3 When the overall distance does not satisfy the MELSECNET/H specifications, either use an A6BR10/A6BR10-DC type repeater unit in the network, or configure a separate network.

#### (b) Distance between stations

○: Compatible, △: Partial change required, ×: Incompatible

Type	MELSECNET (II) module (coaxial loop)	MELSECNET/H module (coaxial bus)	Compatibility	Precautions for replacement
3C-2V	500m	300m	△	Refer to*4 below.
5C-2V	500m	500m	○	

\*4 When the distance between stations does not satisfy the MELSECNET/H specifications, either use an A6BR10/A6BR10-DC type repeater unit in the network.

#### Remarks

The following shows the extension method when a repeater unit for the A6BR10/A6BR10-DC type MELSECNET/10 coaxial bus system is used.

For details, refer to the Repeater Unit for the MELSECNET/10 Coaxial Bus System type A6BR10/A6BR10-DC User's Manual (IB-66499).

(1) The distance between stations of 500m (5C-2V) and 300m (3C-2V) can be extended.

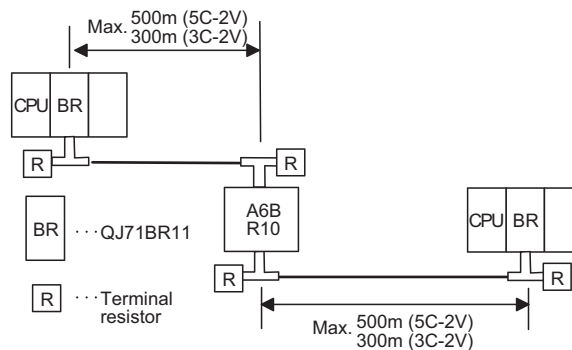

(2) Up to four repeater units can be used in a single network.\*5

The overall distance can be extended to a maximum distance of 2.5 km.

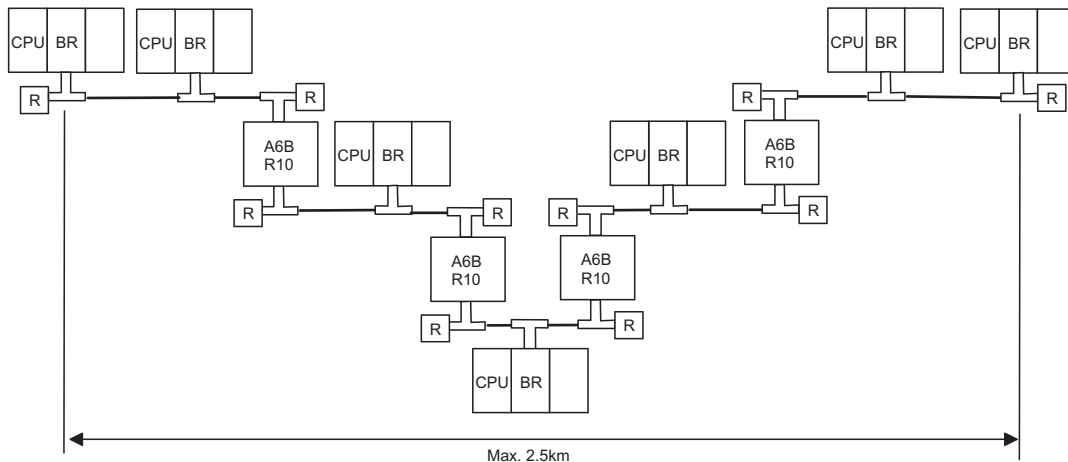

\*5 It is necessary to add terminal resistor A6RCON-R75 (sold separately).

**(3) Twisted pair cable****(a) Overall distance, Distance between stations**

○: Compatible, △: Partial change required, ×: Incompatible

Communication speed	Specifications			Compatibility	Precautions for replacement
	MELSECNET/B module	MELSECNET/H module (QJ71NT11B)			
	Twisted pair cable	Twisted pair cable	CC-Link dedicated cable		
125kbps	1200m	1200m	1200m	○	
250kbps	600m	-	-	○	Change the communication speed from 250Kbps to 312Kbps.
312kbps	-	600m	900m	○	
500kbps	400m	-	-	○	Change the communication speed from 500Kbps to 625Kbps.
625kbps	-	400m	600m	○	
1Mbps	200m	-	-	○	Change the communication speed from 1Mbps to 1.25Mbps.
1.25Mbps	-	200m	400m	○	
2.5Mbps	-	(Not available)	200m	-	New function of MELSECNET/H
5Mbps	-		150m	-	
10Mbps	-		100m	-	

**(b) Cable performance****1) Twisted pair cable**

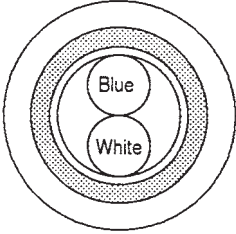
Item	Specifications (KNPEV-SB 0.5SQ × 1P <sup>*1</sup> )
Cable type	Shielded twisted pair cable
Number of cores	2
Conductive resistance (20°C)	39.4 Ω/km or lower
Insulation resistance (20°C)	10 MΩ/km or higher
Dielectric withstand voltage (V-min)	1000 V AC for one minute
Electrostatic capacity (1kHz)	70 nF/km or less (on average)
Characteristic impedance (100kHz)	110 ± 10Ω
Cross section	

- \*1 The same specifications as the MELSECNET/B twisted pair cable.  
 To use the existing MELSECNET/B twisted pair cables, process the terminals.  
 For details, refer to the Q Corresponding MELSECNET/H Network System Reference Manual (PLC to PLC network) (SH-080049).

**2) CC-Link dedicated cable**

Product name	Model name	Remark
Ver. 1.10-compatible CC-Link dedicated cable	FANC-110SBH	
	FA-CBL200PSBH	

## 2.3 Functional Comparisons

○: Compatible, △: Partial change required, ×: Incompatible

Item	Description		Compat- ibility	Precautions for replacement
	MELSECNET ( II ) module MELSECNET/B module	MELSECNET/H module		
Cyclic transmission	<ul style="list-style-type: none"> <li>• X/Y are used to perform 1:1 communications between the master station and local stations, and the master station and remote I/O stations.</li> <li>• B/W are used to perform communications between the master station and all local stations.</li> </ul>	<ul style="list-style-type: none"> <li>• LX/LY are used to perform 1:1 communications between the control station and normal stations.</li> <li>• LB/LW are used to perform communications between the control station and all normal stations.</li> </ul>	○	
Transient transmission	<ul style="list-style-type: none"> <li>• The LRDP/LWTP instructions issued from the master station are used to read/write devices on the programmable controller CPU of local stations.</li> <li>• Other stations are accessed from GX Developer connected to the master station.</li> <li>• The master station is accessed from GX Developer connected to local stations.</li> </ul>	<ul style="list-style-type: none"> <li>• The READ/WRITE/ZNRD/ZNWR instructions issued from the control station are used to read/write devices on the programmable controller CPU of normal stations.</li> <li>• Other stations are accessed from GX Works2 or GX Developer connected to the control station.</li> <li>• The control station and other normal stations are accessed from GX Works2 or GX Developer connected to a normal station.</li> </ul>	△	Correct the LRDP/LWTP instructions for reading/writing devices on the programmable controller CPU of other stations to the READ/WRITE or ZNRD/ZNWR instructions. (Refer to Section 2.6.2.)
Automatic return function	When a disconnected local station returns to normal status, it is automatically restored and the data link is resumed.	When a disconnected normal station returns to normal status, it is automatically restored and the data link is resumed.	○	
Loopback function	In the case of an optical loop system and coaxial loop system, faulty parts are disconnected when a fault (e.g. cable disconnection) occurs, and normal operation is continued on operable stations as a result of the loopback.	In the case of an optical loop system, faulty parts are disconnected when a fault (e.g. cable disconnection) occurs, and normal operation is continued on operable stations as a result of the loopback.	○	
Error detection	Faulty parts are detected by the data of special relays (M9200 to 9255) and special registers (D9200 to 9255).	Faulty parts are detected by the data of link special relays (SB0 to 1FF) and link special registers (SW0 to 1FF).	△	Change the devices in the sequence program. (Refer to Section 2.6.2.)
Self-diagnosis test function	Set the following test items by the mode setting switch: <ul style="list-style-type: none"> <li>• Self-loopback test</li> <li>• Station-to-station test</li> <li>• Forward loop/reverse loop test</li> </ul>	Set the following test items by the mode setting switch: <ul style="list-style-type: none"> <li>• Self-loopback test</li> <li>• Internal self-loopback test</li> <li>• Hardware test</li> </ul> Set the following test items in the network parameters: <ul style="list-style-type: none"> <li>• Station-to-station test</li> <li>• Forward loop/reverse loop test</li> </ul>	△	Set the station-to-station test and forward loop/reverse loop test in the network parameter settings.

## 2.4 Switch Settings Comparisons

### (1) Comparison between MELSECNET (II) modules and MELSECNET/H (optical loop and coaxial bus) modules

○: Compatible, △: Partial change required, ×: Incompatible

Switch name	Description		Compat- ibility	Precautions for replacement
	MELSECNET ( II ) module	MELSECNET/H module		
Station number setting switch	Sets the station number.	Sets the station number.	○	
Mode select switch	Sets the mode for operation or self-diagnostics test.	Sets the mode for operation or self-diagnostics test.	△	Set the station-to-station test and forward loop/ reverse loop test in the GX Works2 or GX Developer network parameters.

### (2) Comparison between MELSECNET/B modules and MELSECNET/H (optical loop and coaxial bus) modules

○: Compatible, △: Partial change required, ×: Incompatible

Switch name	Description		Compat- ibility	Precautions for replacement
	MELSECNET/B module	MELSECNET/H module		
Station number setting switch	Sets the station number.	Sets the station number.	○	
Mode select switch	Sets the mode for operation or self-diagnostics test.	Sets the mode for operation or self-diagnostics test.	△	Set the station-to-station test and forward loop/ reverse loop test in the GX Works2 or GX Developer network parameters
Communication speed setting switch	Sets the communication speed.	-	△	The setting is not required.

### (3) Comparison between MELSECNET/B modules and MELSECNET/H (twisted bus) modules

○: Compatible, △: Partial change required, ×: Incompatible

Switch name	Description		Compat- ibility	Precautions for replacement
	MELSECNET/B module	MELSECNET/H module		
Station number setting switch	Sets the station number.	A station number is set using the station number/mode setting switch.	○	
Mode select switch	Sets the mode for operation or self-diagnostics test.	A self-diagnostic test is set using the station number/mode setting switch.	○	
Communication speed setting switch	Sets the communication speed.	Sets the communication speed.	△	Set a communication speed in the GX Works2 or GX Developer network parameters.

## 2.5 Parameter Comparisons

### 2.5.1 Parameter comparisons

The network parameters of MELSECNET (II) are deleted when the programmable controller type is changed with the GX Developer. After changing the programmable controller type, set the MELSECNET/H network parameters again.

#### (1) Replacing MELSECNET (II) with MELSECNET/H

The following shows a comparison between MELSECNET (II) network parameter settings and MELSECNET/H network parameter settings.

The MELSECNET (II) master station settings are compared with the MELSECNET/H control station settings, and the MELSECNET (II) local station settings are compared with the MELSECNET/H normal station settings.

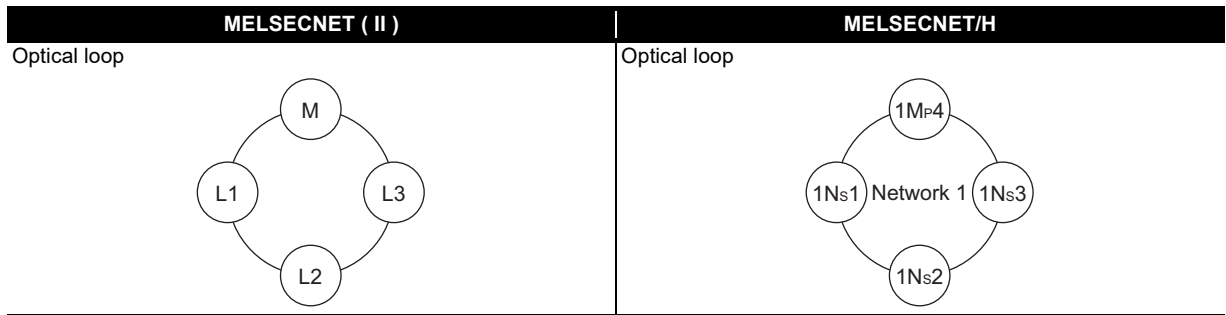

○: Compatible, △: Partial change required, ×: Incompatible

MELSECNET ( II )		MELSECNET/H		Compat- ibility	Precautions for replacement			
Master station	Network type	Network type		○				
	Starting I/O No.*1	Starting I/O No.		○				
	- (No setting)	Network No.		△	Mandatory for the MELSECNET/H.			
	Total number of (normal) stations	Total number of (normal) stations		△	The total number of stations is 64 at maximum.			
	- (No setting)	Group No.		△	Mandatory for the MELSECNET/H.			
	Network range assignments	LB/LW assignments (first half, second half) on the master station and local stations	Control station	Network range assignments	LX/LY assignments on the control station and normal stations	○		
					Station inherent parameter	△	*2	
					Supplemental settings-Secured data send	△	*3	
		LX/LY assignments on the master station and local stations	Normal station	Network range assignments	I/O master station specification	LX/LY assignments on the control station and normal stations	○	
						I/O master station specification	△	Mandatory on communications of LX/LY
Refresh parameters*1	Refresh parameters			○				
Local station	Network type*1	Network type		○				
	Starting I/O No.*1	Starting I/O No.		○				
	- (No setting)	Network No.		△	Mandatory for the MELSECNET/H.			
		Group No.		△	Mandatory for the MELSECNET/H.			
		Station inherent parameter		△	*2			
	Refresh parameters*1	Refresh parameters			○			

\*1 This is set when the AnU/AnUS(H)/QnA/QnASCPU is mounted.

\*2 Applied when LB/LW are set for both the first half/second half on MELSECNET (II). (For details, refer to Section 2.5.2 Example of changing parameters on 2-tier system.)

\*3 This is the data separation prevention function for reading/writing cyclic data of two words or more in a single operation. (For details, refer to Section 2.7 Replacement Precautions.)

## 2.5.2 Example of changing parameters on 2-tier system

The following shows examples of how to change the LB/LW network parameters when replacing the MELSECNET (II) with MELSECNET/H.

As MELSECNET (II) has three operation modes, the examples are shown for each operation mode.

- MELSECNET mode
- MELSECNET II mode
- MELSECNET II composite mode

### (1) MELSECNET mode

The following shows the procedure for changing the parameters in the case of a MELSECNET mode 2-tier system configuration.

The MELSECNET master station is replaced with the MELSECNET/H control station, and MELSECNET local stations are replaced with MELSECNET/H normal stations.

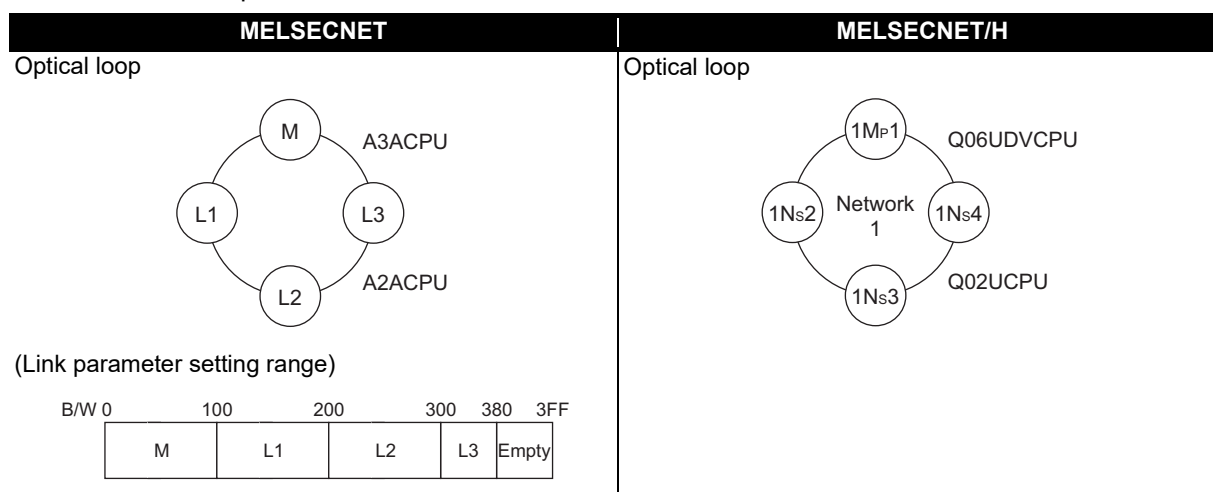

A MELSECNET/H module set as normal station requires network parameter setting. For replacement of MELSECNET (II) module mounted on the CPU module of the AnN/AnA/AnSCPU (excluding AnUS(H)CPU), newly set network parameters.

The following shows parameters required on each station of MELSECNET/H.

	Common parameter (Network range assignment)	Refresh parameter
1Mp1	○ (Refer to example in (c) 2))	△ (Refer to example in (c) 3))
1Ns2		△ (Refer to example in (d) 2))
1Ns3		△ (Refer to example in (d) 2))
1Ns4		△ (Refer to example in (d) 2))

○: Setting required/ △: Setting required (Default setting is also acceptable)



### (a) MELSECNET master station

The following shows the network parameter settings of the MELSECNET master station (A3ACPU).

1) Network parameter setting (A3ACPU: MELSECNET master station)

	Module No.1	Module No.2	Module No.3	Module No.4
Network type	MNET(Master station)	None	None	None
Start I/O No.				
Network No.				
Total stations	3			
Group No.				
Station No.				
Network range assignment				

Necessary setting( No setting / Already set ) Set if it is needed( No setting / Already set )

Start I/O No.:  Valid module during other station access:

Interlink transmission parameters: Input the start I/O No. installed in the module in 16-point unit.

Acknowledge XY assignment    Routing parameters    Check    End    Cancel

2) Network range assignment (A3ACPU: MELSECNET master station)

Setup common parameters

Assignment method:  Points/Start     Start/End

Monitoring time:  × 10ms

Total slave stations:

Switch screens:

L/R station No.	Send range for each station			Send range for each station			M station -> R station			M station <- R station		
	LB			LW			LW			LW		
	Points	Start	End	Points	Start	End	Points	Start	End	Points	Start	End
M 0	256	0000	00FF	256	0000	00FF						
L 1	256	0100	01FF	256	0100	01FF						
L 2	256	0200	02FF	256	0200	02FF						
L 3	128	0300	037F	128	0300	037F						

### (b) MELSECNET local station

As all stations perform cyclic communication according to the network range assignments of the master station (A3ACPU), there are no parameter settings for network range assignment on local stations.

(c) MELSECNET/H control station

The following shows the network parameter settings after replacing with the MELSECNET/H control station (Q06UDVCPU).

1) Network parameter setting (Q06UDVCPU: MELSECNET/H control station)

	Module 1	Module 2	Module 3	Module 4
Network Type	MNET/H Mode(Control Station)	None	None	None
Start I/O No.	0000			
Network No.	1			
Total Stations	4			
Group No.	0			
Station No.				
Mode	Online			
Network Range Assignment				
Refresh Parameters				
Interrupt Settings				
Return as Control Station				
Optical/Coaxial				

2) Network range assignment (Q06UDVCPU: MELSECNET/H control station)

Set up common and station inherent parameters.

Assignment Method:  Points/Start  Start/End

Monitoring Time: 200 X 10ms

Parameter Name:

Total Slave Stations: 4

Switch Screens: LB/LW Setting

Station No.	Send Range for each Station			Send Range for each Station			Send Range for each Station			Send Range for each Station			Pairing	
	LB	LW	Low Speed LB	Low Speed LW	Points	Start	End	Points	Start	End	Points	Start		End
1	256	0000	00FF	256	0000	00FF								Disable
2	256	0100	01FF	256	0100	01FF								Disable
3	256	0200	02FF	256	0200	02FF								Disable
4	128	0300	037F	128	0300	037F								Disable

3) Refresh parameters (Q06UDVCPU: MELSECNET/H control station)

Assignment Method:  Points/Start  Start/End

Transient Transmission Error History Status:  Overwrite  Hold

	Link Side					PLC Side			
	Dev. Name	Points	Start	End		Dev. Name	Points	Start	End
Transfer SB	SB	512	0000	01FF	↔	SB	512	0000	01FF
Transfer SW	SW	512	0000	01FF	↔	SW	512	0000	01FF
Random Cyclic	LB				↔				
Random Cyclic	LW				↔				
Transfer 1	LB	896	0000	037F	↔	B	896	0000	037F
Transfer 2	LW	896	0000	037F	↔	W	896	000000	00037F
Transfer 3					↔				
Transfer 4					↔				
Transfer 5					↔				
Transfer 6					↔				

\* MELSECNET diagnostics may not be displayed correctly although END processing time of CPU is shortened when the points of SB transfer/SW transfer are reduced.

### (d) MELSECNET/H normal station

The following shows the network parameter settings after replacing with a MELSECNET/H normal station (Q02UCPU).

The same parameter settings are required on all normal stations.

1) Network parameter setting (Q02UCPU: MELSECNET/H normal station)

	Module 1	Module 2	Module 3	Module 4
Network Type	MNET/H Mode(Normal Station)	None	None	None
Start I/O No.	0000			
Network No.	1			
Total Stations				
Group No.	0			
Station No.				
Mode	Online			
Station Inherent Parameters				
Refresh Parameters				
Interrupt Settings				

2) Refresh parameters (Q02UCPU: MELSECNET/H normal station)

Assignment Method

Points/Start

Start/End

Transient Transmission Error History Status

Overwrite  Hold

	Link Side					PLC Side			
	Dev. Name	Points	Start	End		Dev. Name	Points	Start	End
Transfer SB	SB	512	0000	01FF	↔	SB	512	0000	01FF
Transfer SW	SW	512	0000	01FF	↔	SW	512	0000	01FF
Random Cyclic	LB				↔				
Random Cyclic	LW				↔				
Transfer 1	LB	896	0000	037F	↔	B	896	0000	037F
Transfer 2	LW	896	0000	037F	↔	W	896	000000	00037F
Transfer 3					↔				
Transfer 4					↔				
Transfer 5					↔				
Transfer 6					↔				

\* MELSECNET diagnostics may not be displayed correctly although END processing time of CPU is shortened when the points of SB transfer/SW transfer are reduced.

### (2) MELSECNET II mode

The following shows the procedure for changing the parameters in the case of a MELSECNET II mode 2-tier system configuration.

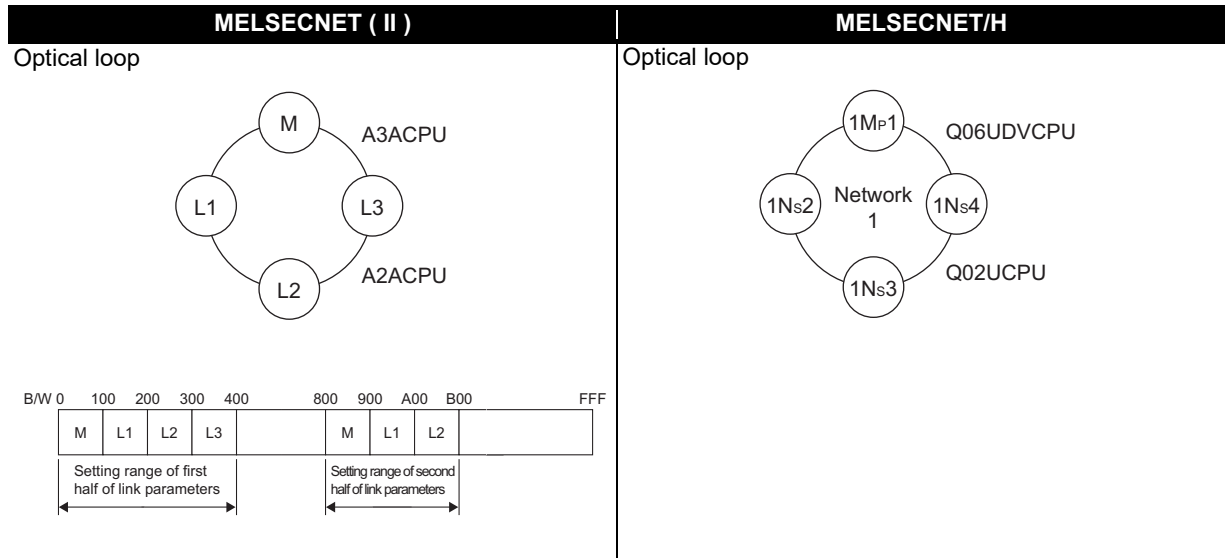

Each of the MELSECNET II first and second half settings correspond to [Setting1] and [Setting2] set to all stations according to the "Station inherent parameters" on MELSECNET/H.

(Example) Station inherent parameters of a normal station (1Ns2)

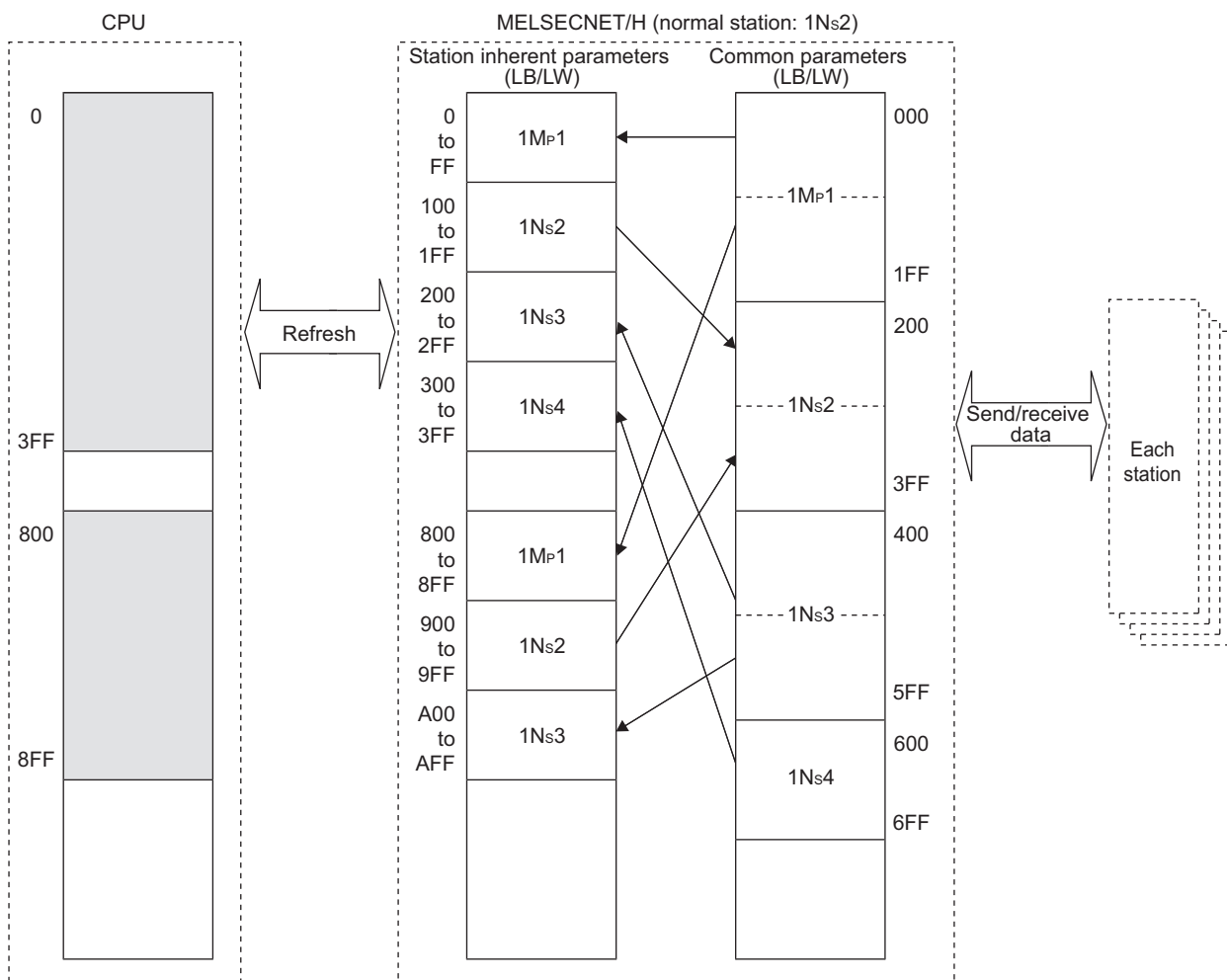

A MELSECNET/H module set as normal station requires network parameter setting. For replacement of MELSECNET (II) module mounted on the CPU module of the AnN/AnA/AnSCPU (excluding AnUS(H)CPU), newly set network parameters.

The following shows parameters required on each station of MELSECNET/H.

	Common parameter (Network range assignment)	Station inherent parameter	Refresh parameter
1Mp1	○ (Refer to example in (b) 2))	○ (Refer to example in (b) 3))	△ (Refer to example in (b) 4))
1Ns2		○ (Refer to example in (c) 2))	△ (Refer to example in (c) 3))
1Ns3		○ (Refer to example in (c) 2))	△ (Refer to example in (c) 3))
1Ns4		○ (Refer to example in (c) 2))	△ (Refer to example in (c) 3))

○: Setting required/ △: Setting required (Default setting is also acceptable)

### (a) MELSECNET II master station

The following shows the network parameter settings of the MELSECNET II master station (A3ACPU).

#### 1) Network parameter setting (A3ACPU: MELSECNET II master station)

#### 2) Network range assignment (A3ACPU: MELSECNET II master station)

L/R station No.	Send range for each station			Send range for each station			Send range for each station			Send range for each station		
	First half LB			First half LW			Second half LB			Second half LW		
	Points	Start	End	Points	Start	End	Points	Start	End	Points	Start	End
M 0	256	0000	00FF	256	0000	00FF	256	0800	08FF	256	0800	08FF
II L 1	256	0100	01FF	256	0100	01FF	256	0900	09FF	256	0900	09FF
II L 2	256	0200	02FF	256	0200	02FF	256	0A00	0AFF	256	0A00	0AFF
II L 3	256	0300	03FF	256	0300	03FF						

### (b) MELSECNET/H control station

Each of the MELSECNET II first and second half settings correspond to [Setting1] and [Setting2] set according to the "Station inherent parameters" on MELSECNET/H.

Points when replacing the first and second half of MELSECNET II

MELSECNET sequence programs can be re-used more efficiently by using the station inherent parameters of MELSECNET/H. The followings describe the points when setting station inherent parameters.

- Set station inherent parameters to all stations.

#### 1) Network parameter

The network parameter settings of the MELSECNET/H control station (Q06UDVCPU) are the same as the parameters when replaced with the MELSECNET mode.

Network parameter setting (Q06UDVCPU: MELSECNET/H control station)

	Module 1	Module 2	Module 3	Module 4
Network Type	MNET/H Mode(Control Station)	None	None	None
Start I/O No.	0000			
Network No.	1			
Total Stations	4			
Group No.	0			
Station No.				
Mode	Online			
	Network Range Assignment			
	Refresh Parameters			
	Interrupt Settings			
	Return as Control Station			
	Optical/Coaxial			

#### 2) Network range assignment parameter

Set the total number of points in the first half and second half for the common parameters.

Network range assignment (Q06UDVCPU: MELSECNET/H control station)

Set up common and station inherent parameters.

Assignment Method  
 Points/Start  
 Start/End

Monitoring Time: 200 X 10ms  
 Total Slave Stations: 4  
 Parameter Name:   
 Switch Screens: LB/LW Setting

Station No.	Send Range for each Station LB			Send Range for each Station LW			Low Speed LB			Low Speed LW			Pairing
	Points	Start	End	Points	Start	End	Points	Start	End	Points	Start	End	
1	512	0000	01FF	512	0000	01FF							Disable
2	512	0200	03FF	512	0200	03FF							Disable
3	512	0400	05FF	512	0400	05FF							Disable
4	256	0600	06FF	256	0600	06FF							Disable

### 3) Station inherent parameter

Set the first half in [Setting1] and the second half in [Setting2] as the inherent parameters.

Station inherent parameter (Q06UDVCPUCPU: MELSECNET/H control station)

Reference Network Range Assignment

Workspace Location:

Workspace Name:

Project Name:  Board No.:

Reference    Read    Cancel

Assignment Method

Points/Start

Start/End

Parameter Name:

Switch Screens:

Station No.	Setting 1			Setting 2			Network Range Assignment			Pairing
	LB			LB			LB			
	Points	Start	End	Points	Start	End	Points	Start	End	
1	256	0000	00FF	256	0800	08FF				Disable
2	256	0100	01FF	256	0900	09FF				Disable
3	256	0200	02FF	256	0A00	0AFF				Disable
4	256	0300	03FF							Disable

### 4) Refresh parameters

Refresh parameters (Q06UDVCPUCPU: MELSECNET/H control station)

Assignment Method

Points/Start

Start/End

Transient Transmission Error History Status

Overwrite     Hold

	Link Side					PLC Side			
	Dev. Name	Points	Start	End		Dev. Name	Points	Start	End
Transfer SB	SB	512	0000	01FF	↔	SB	512	0000	01FF
Transfer SW	SW	512	0000	01FF	↔	SW	512	0000	01FF
Random Cyclic	LB				↔				
Random Cyclic	LW				↔				
Transfer 1	LB	8192	0000	1FFF	↔	B	8192	0000	1FFF
Transfer 2	LB	768	0800	0AFF	↔	B	768	0800	0AFF
Transfer 3	LW	1024	0000	03FF	↔	W	1024	000000	0003FF
Transfer 4	LW	768	0800	0AFF	↔	W	768	000800	000AFF
Transfer 5					↔				
Transfer 6					↔				

\* MELSECNET diagnostics may not be displayed correctly although END processing time of CPU is shortened when the points of SB transfer/SW transfer are reduced.

(c) MELSECNET/H normal station

1) Network parameter setting

The network parameter settings of MELSECNET/H normal stations (Q02UCPU) are the same as those of MELSECNET/H normal stations when replaced with the MELSECNET mode. (Refer to the Section 2.5.2 (1) MELSECNET mode.)

2) Station inherent parameter

For the station inherent parameter settings, settings of the same content as that for the control stations has to be set to all normal stations.

Station inherent parameter (Q02UCPU: MELSECNET/H normal station)

Station No.	Setting 1			Setting 2			Network Range Assignment			Pairing
	Points	Start	End	Points	Start	End	Points	Start	End	
1	256	0000	00FF	256	0800	08FF	512	0000	01FF	Disable
2	256	0100	01FF	256	0900	09FF	512	0200	03FF	Disable
3	256	0200	02FF	256	0A00	0AFF	512	0400	05FF	Disable
4	256	0300	03FF				256	0600	06FF	Disable

3) Refresh parameters

The same parameter settings are required on all normal stations.

Refresh parameters (Q02UCPU: MELSECNET/H normal station)

	Link Side					PLC Side			
	Dev. Name	Points	Start	End		Dev. Name	Points	Start	End
Transfer SB	SB	512	0000	01FF	↔	SB	512	0000	01FF
Transfer SW	SW	512	0000	01FF	↔	SW	512	0000	01FF
Random Cyclic	LB				↔				
Random Cyclic	LW				↔				
Transfer 1	LB	1024	0000	03FF	↔	B	1024	0000	03FF
Transfer 2	LB	768	0800	0AFF	↔	B	768	0800	0AFF
Transfer 3	LW	1024	0000	03FF	↔	W	1024	000000	0003FF
Transfer 4	LW	768	0800	0AFF	↔	W	768	000800	000AFF
Transfer 5					↔				
Transfer 6					↔				

\* MELSECNET diagnostics may not be displayed correctly although END processing time of CPU is shortened when the points of SB transfer/SW transfer are reduced.



### (3) MELSECNET II composite mode

The following shows the procedures for changing the parameters in the case of a MELSECNET II composite mode 2-tier system configuration on an A3ACPU.

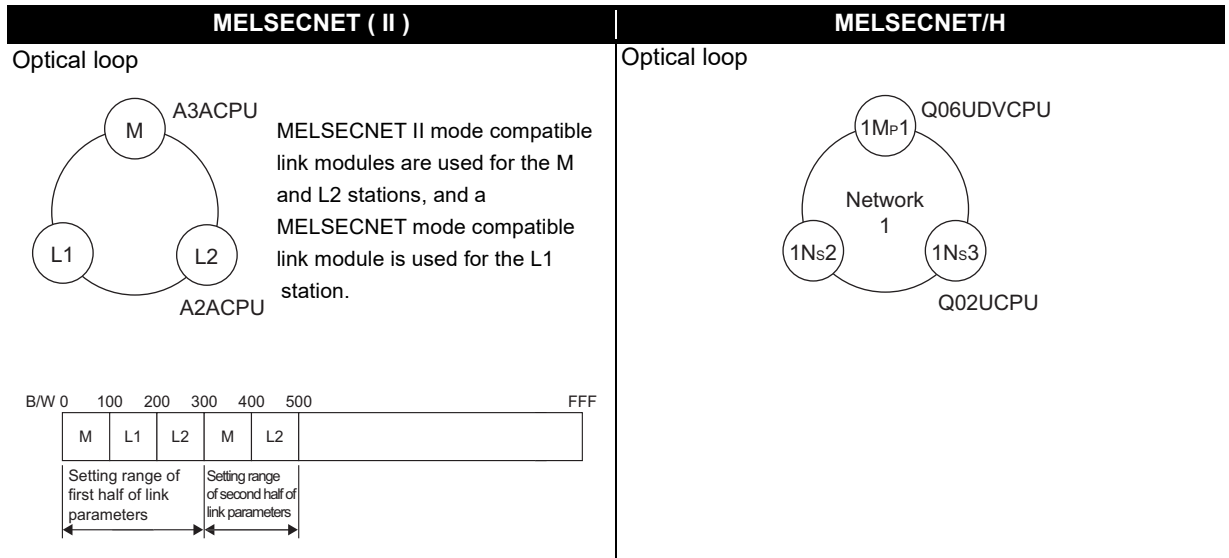

A MELSECNET/H module set as normal station requires network parameter setting. For replacement of MELSECNET (II) module mounted on the CPU module of the AnN/AnA/AnSCPU (excluding AnUS(H)CPU), newly set network parameters.

The following shows parameters required on each station of MELSECNET/H.

	Common parameter (Network range assignment)	Station inherent parameter	Refresh parameter
1Mp1	○ (Refer to example in (b) 2))	○ (Refer to example in (b) 3))	△ (Refer to example in (b) 4))
1Ns2	/	○ (Refer to example in (c) 2))	△ (Refer to example in (c) 3))
1Ns3	/	○ (Refer to example in (c) 2))	△ (Refer to example in (c) 3))

○: Setting required/ △: Setting required (Default setting is also acceptable)

### (a) MELSECNET II composite mode master station

The following shows the network parameter settings of the MELSECNET II composite mode master station (A3ACPU).

#### 1) Network parameter setting (A3ACPU: MELSECNET II composite mode master station)

	Module No.1	Module No.2	Module No.3	Module No.4
Network type	MNET II comp. (Master station)	None	None	None
Start I/O No.				
Network No.				
Total stations	2			
Group No.				
Station No.				
Network range assignment				
Necessary setting( No setting / Already set ) Set if it is needed( No setting / Already set )				
Interlink transmission parameters	Start I/O No.: Input the start I/O No. installed in the module in 16-point unit.		Valid module during other station access	1
Acknowledge XY assignment	Routing parameters	Check	End	Cancel

#### 2) Network range assignment (A3ACPU: MELSECNET II composite mode master station) : First half

Setup common parameters

Assignment method  
 Points/Start  
 Start/End

Monitoring time: 200 × 10ms  
 Total slave stations: 2  
 Switch screens: First half LB/LW setting

L/R station No.	Send range for each station			Send range for each station			M station -> R station			M station <- R station		
	First half LB			First half LW			LW			LW		
	Points	Start	End	Points	Start	End	Points	Start	End	Points	Start	End
M 0	256	0000	00FF	256	0000	00FF						
L 1	256	0100	01FF	256	0100	01FF						
II L 2	256	0200	02FF	256	0200	02FF						

#### 3) Network range assignment (A3ACPU: MELSECNET II composite mode master station) : Second half

Setup common parameters

Assignment method  
 Points/Start  
 Start/End

Monitoring time: 200 × 10ms  
 Total slave stations: 2  
 Switch screens: Second half LB/LW setting

L/R station No.	Send range for each station			Send range for each station								
	Second half LB			Second half LW								
	Points	Start	End	Points	Start	End	Points	Start	End	Points	Start	End
M 0	256	0300	03FF	256	0300	03FF						
L 1												
II L 2	256	0400	04FF	256	0400	04FF						

### (b) Q06UDVCPU (control station)

Each of the MELSECNET II first and second half settings correspond to [Setting1] and [Setting2] set according to the "Station inherent parameters" on MELSECNET/H.

Points when replacing the first and second half of MELSECNET II  
 MELSECNET sequence programs can be re-used more efficiently by using the station inherent parameters of MELSECNET/H.  
 The followings describe the points when setting station inherent parameters.

- Set station inherent parameters to all stations.

#### 1) Network parameter

The network parameter settings of the MELSECNET/H control station (Q06UDVCPU) are the same as the parameters when replaced with the MELSECNET mode.

Network parameter setting (Q06UDVCPU: MELSECNET/H control station)

	Module 1	Module 2	Module 3	Module 4
Network Type	MNET/H Mode(Control Station) ▼	None ▼	None ▼	None ▼
Start I/O No.	0000			
Network No.	1			
Total Stations	3			
Group No.	0			
Station No.				
Mode	Online ▼	▼	▼	▼
	Network Range Assignment			
	Refresh Parameters			
	Interrupt Settings			
	Return as Control Station ▼			
	Optical/Coaxial ▼			

#### 2) Network range assignment parameter

Set the total number of points in the first half and second half for the common parameters.

Network range assignment (Q06UDVCPU: MELSECNET/H control station)

Set up common and station inherent parameters.

Assignment Method:  
 Points/Start  
 Start/End

Monitoring Time:  X 10ms  
 Parameter Name:

Total Slave Stations:   
 Switch Screens:

Station No.	Send Range for each Station LB			Send Range for each Station LW			Send Range for each Station Low Speed LB			Send Range for each Station Low Speed LW			Pairing
	Points	Start	End	Points	Start	End	Points	Start	End	Points	Start	End	
1	512	0000	01FF	512	0000	01FF							Disable ▼
2	256	0200	02FF	256	0200	02FF							Disable ▼
3	512	0300	04FF	256	0400	04FF							Disable ▼

3) Station inherent parameter

Set the first half in [Setting1] and the second half in [Setting2] as the inherent parameters.

Station inherent parameter (Q06UDVCPUCPU: MELSECNET/H control station)

Reference Network Range Assignment

Workspace Location:

Workspace Name:

Project Name:  Board No.:

Reference    Read    Cancel

Assignment Method

Points/Start

Start/End

Parameter Name:

Switch Screens:

Station No.	Setting 1			Setting 2			Network Range Assignment			Pairing
	LB			LB			LB			
	Points	Start	End	Points	Start	End	Points	Start	End	
1	256	0000	00FF	256	0300	03FF	512	0000	01FF	Disable
2	256	0100	01FF				256	0200	02FF	Disable
3	256	0200	02FF	256	0400	04FF	512	0300	04FF	Disable

4) Refresh parameters

Refresh parameters (Q06UDVCPUCPU: MELSECNET/H control station)

Assignment Method

Points/Start

Start/End

Transient Transmission Error History Status

Overwrite     Hold

	Link Side					PLC Side			
	Dev. Name	Points	Start	End		Dev. Name	Points	Start	End
Transfer SB	SB	512	0000	01FF	↔	SB	512	0000	01FF
Transfer SW	SW	512	0000	01FF	↔	SW	512	0000	01FF
Random Cyclic	LB				↔				
Random Cyclic	LW				↔				
Transfer 1	LB	1280	0000	04FF	↔	B	1280	0000	04FF
Transfer 2	LW	1280	0000	04FF	↔	W	1280	000000	0004FF
Transfer 3					↔				
Transfer 4					↔				
Transfer 5					↔				
Transfer 6					↔				

\* MELSECNET diagnostics may not be displayed correctly although END processing time of CPU is shortened when the points of SB transfer/SW transfer are reduced.

(c) MELSECNET/H normal station

1) network parameter setting

The network parameter settings of MELSECNET/H normal stations (Q02UCPU) are the same as those of MELSECNET/H normal stations when replaced with the MELSECNET mode. (Refer to the MELSECNET mode.)

2) Station inherent parameter

For the station inherent parameter settings, settings of the same content as that for the control stations has to be set to all normal stations. (Refer to the station inherent parameters of the MELSECNET/H control station.)

Station inherent parameter (Q02UCPU: MELSECNET/H normal station)

Station No.	Setting 1			Setting 2			Network Range Assignment			Pairing
	Points	Start	End	Points	Start	End	Points	Start	End	
1	256	0000	00FF	256	0300	03FF	512	0000	01FF	Disable
2	256	0100	01FF				256	0200	02FF	Disable
3	256	0200	02FF	256	0400	04FF	512	0300	04FF	Disable

3) Refresh parameters

The same parameter settings are required on all normal stations.

Refresh parameters (Q02UCPU: MELSECNET/H normal station)

	Link Side					PLC Side			
	Dev. Name	Points	Start	End		Dev. Name	Points	Start	End
Transfer SB	SB	512	0000	01FF	↔	SB	512	0000	01FF
Transfer SW	SW	512	0000	01FF	↔	SW	512	0000	01FF
Random Cyclic	LB				↔				
Random Cyclic	LW				↔				
Transfer 1	LB	1280	0000	04FF	↔	B	1280	0000	04FF
Transfer 2	LW	1280	0000	04FF	↔	W	1280	000000	0004FF
Transfer 3					↔				
Transfer 4					↔				
Transfer 5					↔				
Transfer 6					↔				

\* MELSECNET diagnostics may not be displayed correctly although END processing time of CPU is shortened when the points of SB transfer/SW transfer are reduced.

### 2.5.3 Example of changing parameters on 3-tier system (When only the first half of link parameter is set)

The following shows how to change a system on which first half of LB/LW link parameters is set, when replacing the MELSECNET (II) 3-tier system with MELSECNET/H. Network range assignment of the present MELSECNET (II) 3-tier system can be used in replacement with MELSECNET/H.

The MELSECNET (II) 2-tier is replaced with the network 1 of MELSECNET/H, and 3-tier is replaced with the network 2. The MELSECNET (II) master station is replaced with the MELSECNET/H control station, and MELSECNET local stations are replaced with MELSECNET/H normal stations.

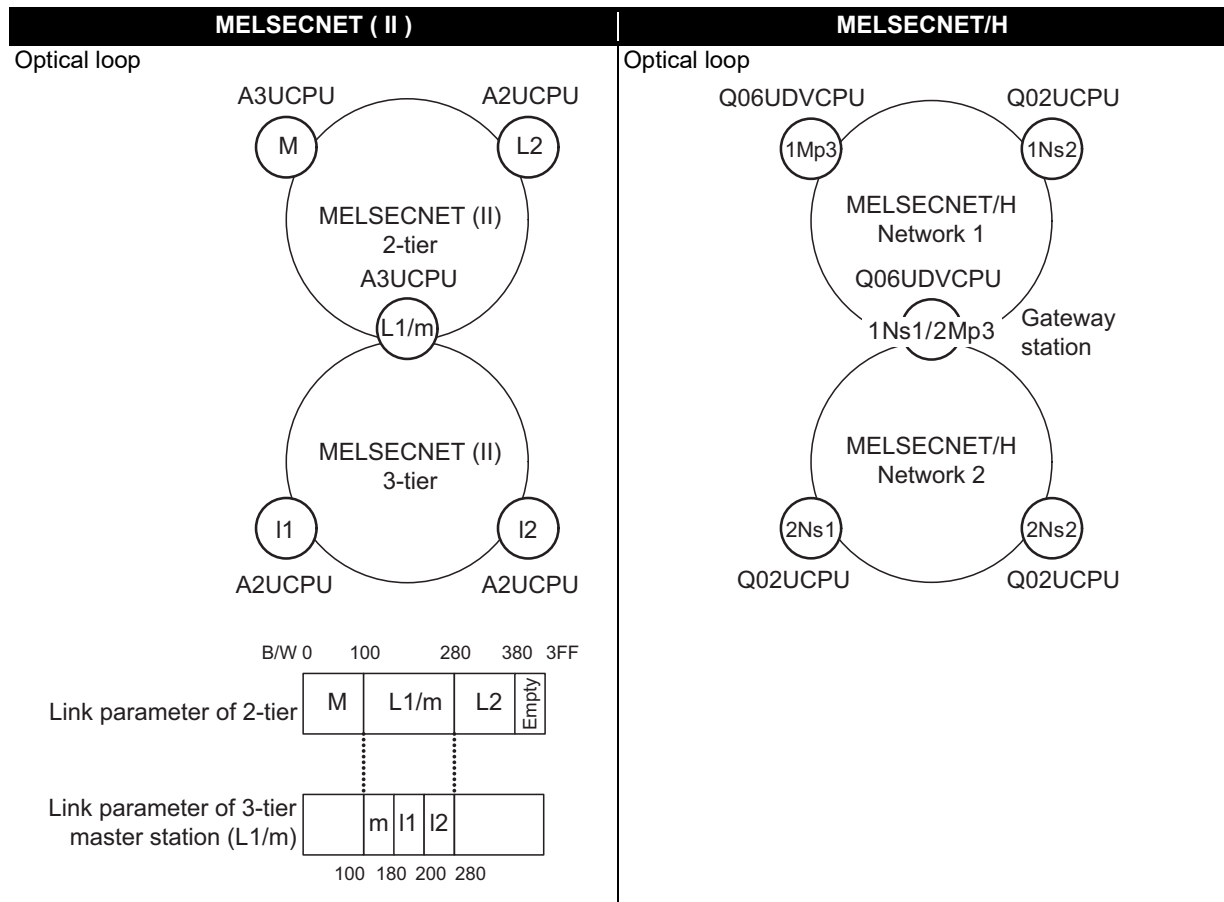

#### Concept of MELSECNET (II) 3-tier system replacement

##### Step 1: Control station (1Mp3) setting

Replace the link parameter setting of MELSECNET (II) 2-tier master station directly with "Network range assignment (Common parameters)" of MELSECNET/H network 1 control station 1Mp3.

##### Step 2: Gateway station (1Ns1/2Mp3) setting

Data transfer between 2 and 3-tier, performed automatically on MELSECNET (II), should be set with parameter setting on MELSECNET/H. Perform the following settings.

- Replace the link parameter setting of MELSECNET (II) 3-tier master station directly with "Network range assignment (Common parameters)" of MELSECNET/H network 2 control station 2Mp3.  
The range assignment should be performed including the same LB/LW size as that of 1Mp3 to relay the network 1 control station 1Mp3.
- Set "Refresh parameters" not to duplicate B/W of networks 1 and 2 on the CPU.
- Set data transfer between 2 and 3-tier of MELSECNET (II) in "Interlink transmission parameters" between gateway stations 1Ns1 and 2Mp3.

##### Step 3: Normal station (1Ns2, 2Ns1, 2Ns2) setting

Set "Refresh parameters" of each normal station (1Ns2, 2Ns1, 2Ns2) on MELSECNET/H networks 1 and 2.

The following shows the flow of MELSECNET/H link data after being replaced from MELSECNET (II).

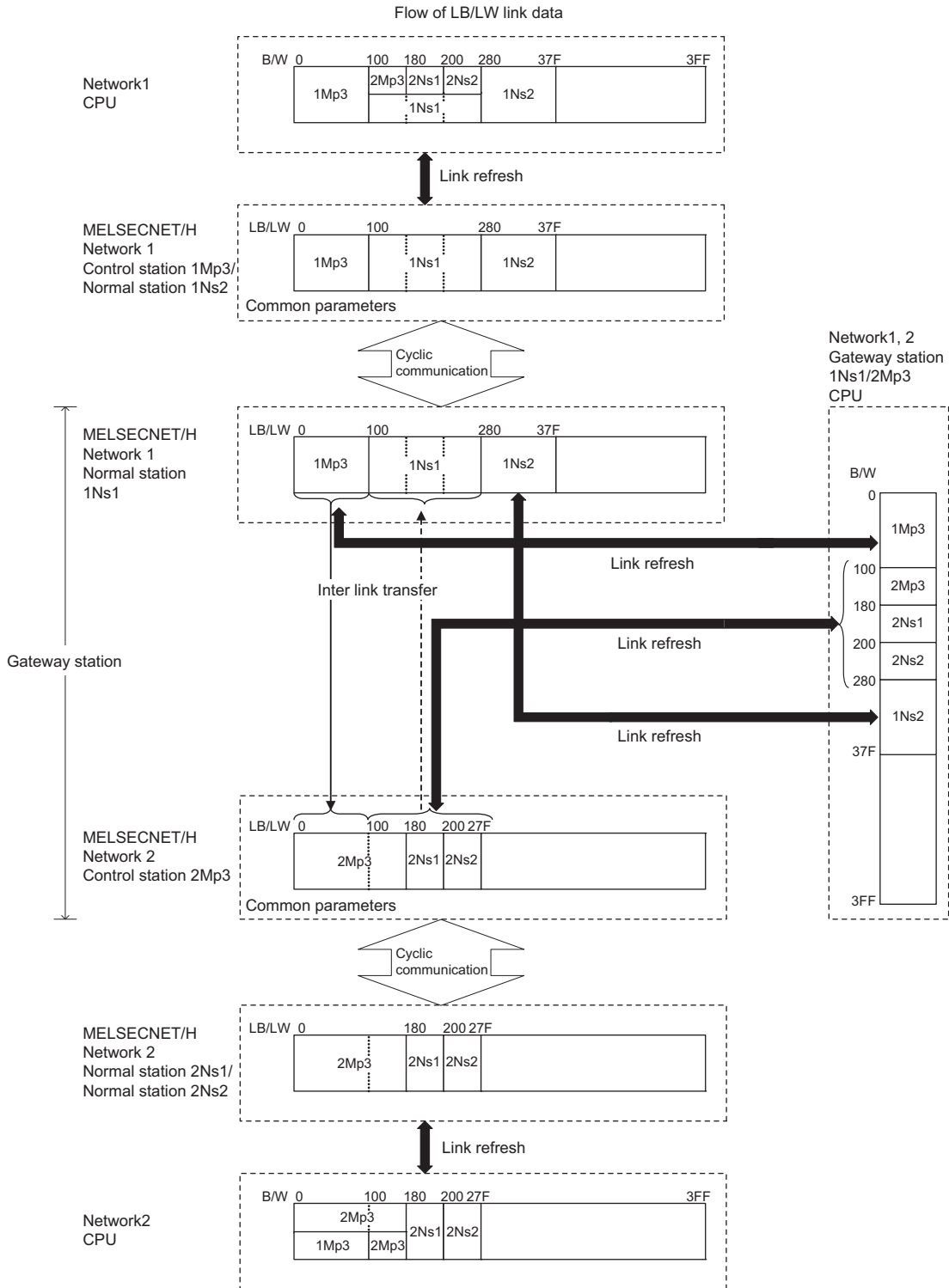

[Designation of arrow in the figure]

- Cyclic communication
  - Transfers LB/LW which has been set on common parameter to all stations of MELSECNET/H by cyclic communication.
- Inter-link data transfer
  - Inter-link data transfer from module 1 to 2
  - Inter-link data transfer from module 2 to 1
  - Transfers LB/LW between modules with different network numbers mounted to one CPU.
- Link refresh
  - Transfers LB/LW of MELSECNET/H to the device of CPU.

Network parameter setting is required for control and normal stations on MELSECNET/H.

The following shows parameters required on each station of MELSECNET/H.

	Common parameter (Network range assignment)	Station inherent parameter	Refresh parameter	Inter-link data transfer
1Mp3	○ (Refer to example in (e) 2))	-	△ (Refer to example in (e) 3))	
1Ns2		-	△ (Refer to example in (f) 2))	
1Ns1		-	○ (Refer to example in (g) 2))	○ (Refer to example in (h) 1))
2Mp3	○ (Refer to example in (g) 3))	-	○ (Refer to example in (g) 4))	
2Ns1		-	△ (Refer to example in (i) 2))	
2Ns2		-	△ (Refer to example in (i) 2))	

○: Setting required/ △: Setting required (Default setting is also acceptable)/ -: Setting not required



### (a) MELSECNET (II) 2-tier master station M

The following describes the network parameter setting of MELSECNET (II) 2-tier master station M (A3UCPU).

#### 1) Network parameter setting (A3UCPU: MELSECNET (II) 2-tier master station M)

	Module No.1	Module No.2	Module No.3	Module No.4
Network type	MNET II (Master station)	None	None	None
Start I/O No.	0000			
Network No.				
Total stations	2			
Group No.				
Station No.				
Network range assignment				
Refresh parameters				

Necessary setting( No setting / Already set ) Set if it is needed( No setting / Already set )

Start I/O No.: Input the start I/O No. installed in the module in 16-point unit. Valid module during other station access: 1

Interlink transmission parameters Acknowledge XY assignment Routing parameters Check End Cancel

#### 2) Network range assignment (A3UCPU: MELSECNET (II) 2-tier master station M)

Setup common parameters

Assignment method:  Points/Start  Start/End

Monitoring time: 200 × 10ms

Total slave stations: 2

Switch screens: LB/LW settings

L/R station No.	Send range for each station			Send range for each station			Send range for each station			Send range for each station		
	First half LB			First half LW			Second half LB			Second half LW		
	Points	Start	End	Points	Start	End	Points	Start	End	Points	Start	End
M 0	256	0000	00FF	256	0000	00FF						
II L 1	384	0100	027F	384	0100	027F						
II L 2	256	0280	037F	256	0280	037F						

#### 3) Refresh parameter (A3UCPU: MELSECNET (II) 2-tier master station M)

Assignment method:  Points/Start  Start/End

Transient transmission error history status:  Overwrite  Hold

	Link side				PLC side			
	Points	Start	End		BlockNo.	Points	Start	End
LB<->B transmission(1)	896	0000	037F	↔		896	0000	037F
LW<->W transmission(1)	896	0000	037F	↔		896	0000	037F
LX/LY<->XY transmission	2048	0000	07FF	↔		2048	0000	07FF

**(b) MELSECNET (II) 2-tier local station L2**

As the cyclic communication is performed according to the network range assignments of the 2-tier master station (A3UCPU), there is no parameter setting for network range assignment on 2-tier local stations.

**(c) MELSECNET (II) 2-tier local station L1/3-tier master station m**

The following describes the network parameter setting of MELSECNET (II) 2-tier local station L1/3-tier master station m (A3UCPU).

1) Network parameter setting (A3UCPU: MELSECNET (II) 2-tier local station L1/3-tier master station m)

	Module No.1	Module No.2	Module No.3	Module No.4
Network type	MNET II (Local station)	MNET II (Master station)	None	None
Start I/O No.	0000	0020		
Network No.				
Total stations		2		
Group No.				
Station No.				
		Network range assignment		
		Refresh parameters		

Necessary setting( No setting / Already set ) Set if it is needed( No setting / Already set )

Start I/O No.: Input the start I/O No. installed in the module in 16-point unit. Valid module during other station access 1

Interlink transmission parameters Acknowledge XY assignment Routing parameters Check End Cancel

2) Network range assignment (A3UCPU: MELSECNET (II) 3-tier master station m)

Setup common parameters

Assignment method:  Points/Start  Start/End

Monitoring time: 200 X 10ms

Total slave stations: 2

Switch screens: LB/LW settings

L/R station No.	Send range for each station			Send range for each station			Send range for each station			Send range for each station		
	Points	Start	End	Points	Start	End	Points	Start	End	Points	Start	End
M 0	128	0100	017F	128	0100	017F						
II L 1	128	0180	01FF	128	0180	01FF						
II L 2	128	0200	027F	128	0200	027F						

3) Refresh parameter (A3UCPU: MELSECNET (II) 3-tier master station m)

Assignment method:  Points/Start  Start/End

Transient transmission error history status:  Overwrite  Hold

	Link side				PLC side			
	Points	Start	End		BlockNo.	Points	Start	End
LB<->B transmission(1)	640	0000	027F	↔		640	0000	027F
LW<->W transmission(1)	640	0000	027F	↔		640	0000	027F
LX/LY<->XY transmission	2048	0000	07FF	↔		2048	0000	07FF

**(d) MELSECNET (II) 3-tier local station I1, I2**

As the cyclic communication is performed according to the network range assignments of the 3-tier master station (A3UCPU), there is no parameter setting for network range assignment on 3-tier local stations.

### (e) MELSECNET/H network 1 control station 1Mp3

For MELSECNET/H network 1 control station 1Mp3, change the settings of MELSECNET (II) 2-tier master station by:

- Assigning LB/LW to each station by the setting of "Network range assignment (Common parameters)"
- Performing B/W refreshment by the setting of "Refresh parameters"

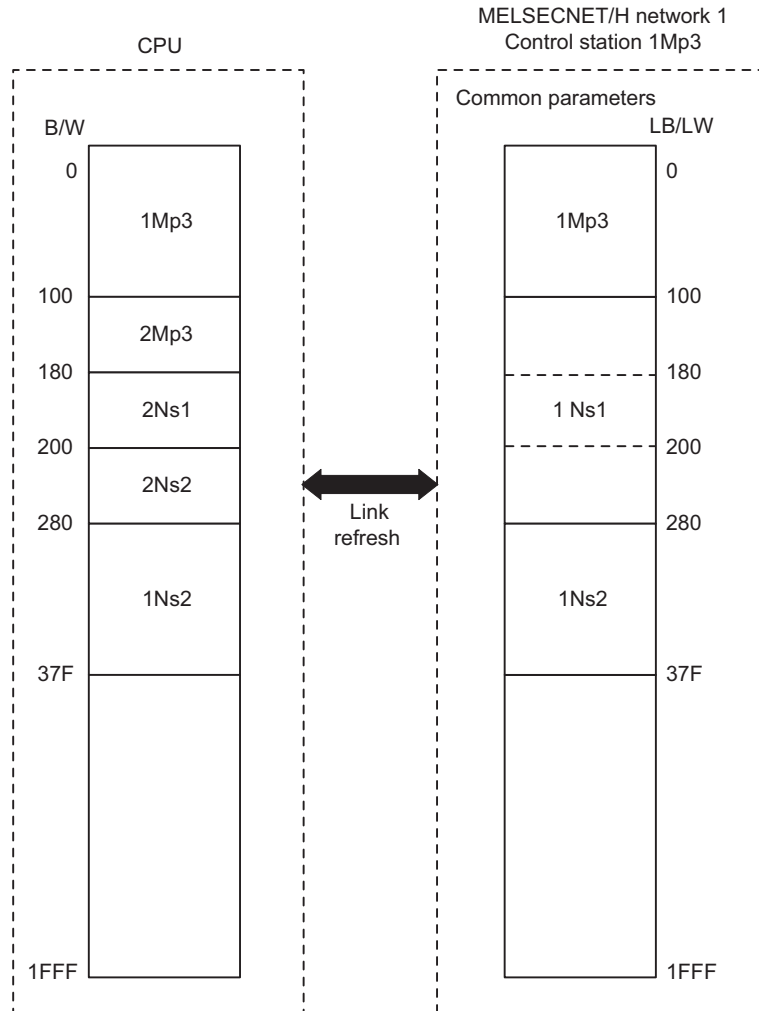

The following describes the network parameter setting of MELSECNET/H network 1 control station 1Mp3 (Q06UDVCPU).

### 1) Network parameter setting (Q06UDVCPU: MELSECNET/H network 1 control station 1Mp3)

	Module 1	Module 2	Module 3	Module 4
Network Type	MNET/H Mode(Control Station)	None	None	None
Start I/O No.	0000			
Network No.	1			
Total Stations	3			
Group No.	0			
Station No.				
Mode	Online			
Network Range Assignment				
Refresh Parameters				
Interrupt Settings				
	Return as Control Station			
	Optical/Coaxial			

### 2) Network range assignment (Q06UDVCPU: MELSECNET/H network 1 control station 1Mp3)

Set up common and station inherent parameters.

Assignment Method:  
 Points/Start  
 Start/End

Monitoring Time: 200 X 10ms  
 Parameter Name:   
 Total Slave Stations: 3  
 Switch Screens: LB/LW Setting

Station No.	Send Range for each Station			Send Range for each Station			Send Range for each Station			Send Range for each Station			Pairing
	LB			LW			Low Speed LB			Low Speed LW			
	Points	Start	End	Points	Start	End	Points	Start	End	Points	Start	End	
1	384	0100	027F	384	0100	027F							Disable
2	256	0280	037F	256	0280	037F							Disable
3	256	0000	00FF	256	0000	00FF							Disable

### 3) Refresh parameter (Q06UDVCPU: MELSECNET/H network 1 control station 1Mp3)

Assignment Method:  
 Points/Start  
 Start/End

Transient Transmission Error History Status:  
 Overwrite  Hold

	Link Side						PLC Side			
	Dev. Name	Points	Start	End			Dev. Name	Points	Start	End
Transfer SB	SB	512	0000	01FF	↔	SB	512	0000	01FF	
Transfer SW	SW	512	0000	01FF	↔	SW	512	0000	01FF	
Random Cyclic	LB				↔					
Random Cyclic	LW				↔					
Transfer 1	LB	896	0000	037F	↔	B	896	0000	037F	
Transfer 2	LW	896	0000	037F	↔	W	896	000000	00037F	
Transfer 3					↔					
Transfer 4					↔					
Transfer 5					↔					
Transfer 6					↔					

\*MELSECNET diagnostics may not be displayed correctly although END processing time of CPU is shortened when the points of SB transfer/SW transfer are reduced.

**(f) MELSECNET/H network 1 normal station 1Ns2**

For MELSECNET/H network 1 normal station 1Ns2 that is not gateway station, change the settings by:

- Performing B/W refreshment by the setting of "Refresh parameters"

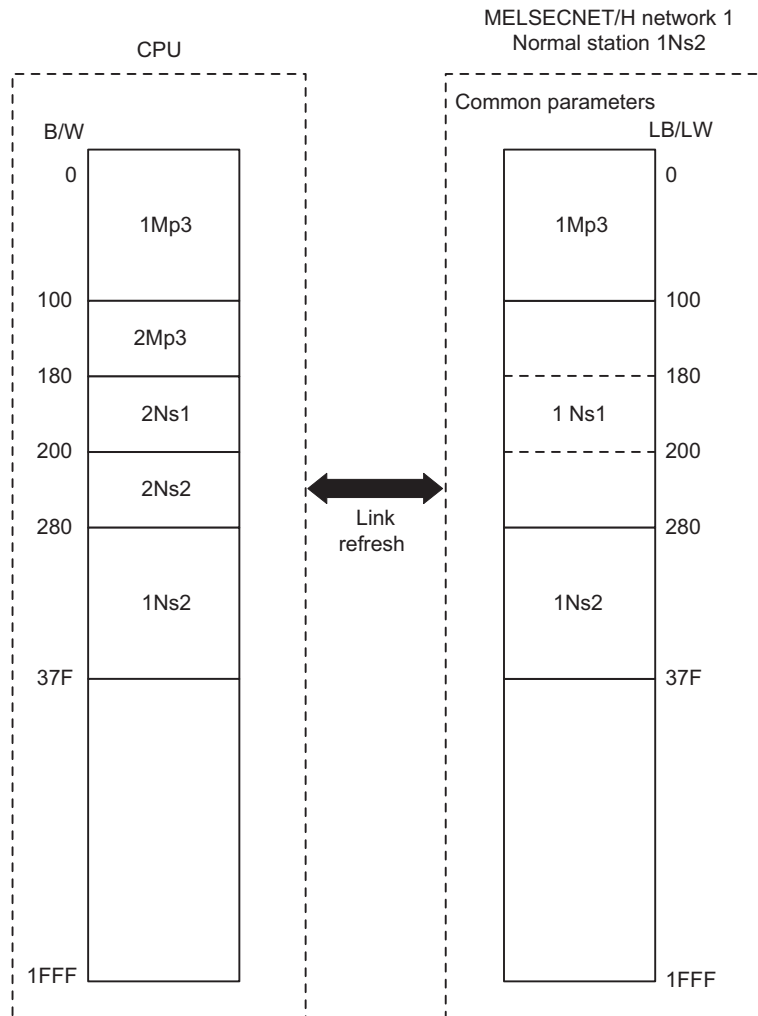

The following describes the network parameter setting of MELSECNET/H network 1 normal station 1Ns2 (Q02UCPU).

1) Network parameter setting (Q02UCPU: MELSECNET/H network 1 normal station)

	Module 1	Module 2	Module 3	Module 4
Network Type	MNET/H Mode(Normal Station)	None	None	None
Start I/O No.	0000			
Network No.	1			
Total Stations				
Group No.	0			
Station No.				
Mode	Online			
	Station Inherent Parameters			
	Refresh Parameters			
	Interrupt Settings			

2) Refresh parameter (Q02UCPU: MELSECNET/H network 1 normal station 1Ns2)

Assignment Method

Points/Start

Start/End

Transient Transmission Error History Status

Overwrite  Hold

	Link Side				↔	PLC Side			
	Dev. Name	Points	Start	End		Dev. Name	Points	Start	End
Transfer SB	SB	512	0000	01FF	↔	SB	512	0000	01FF
Transfer SW	SW	512	0000	01FF	↔	SW	512	0000	01FF
Random Cyclic	LB				↔				
Random Cyclic	LW				↔				
Transfer 1	LB	896	0000	037F	↔	B	896	0000	037F
Transfer 2	LW	896	0000	037F	↔	W	896	000000	00037F
Transfer 3					↔				
Transfer 4					↔				
Transfer 5					↔				
Transfer 6					↔				

\* MELSECNET diagnostics may not be displayed correctly although END processing time of CPU is shortened when the points of SB transfer/SW transfer are reduced.

**(g) MELSECNET/H network 1 normal station 1Ns1/Network 2 control station 2Mp3  
(Network range assignment of gateway stations, refresh parameters)**

For MELSECNET/H network 1 normal station 1Ns1 that is gateway station, change the settings by:

- Performing B/W refreshment by the setting of "Refresh parameters"\*1

For MELSECNET/H network 2 control station 2Mp3 that is gateway station, change the settings of MELSECNET (II) 3-tier master station by:

- Assigning LB/LW to each station by the setting of "Network range assignment (Common parameters)\*2
- Assigning B/W refreshment by the setting of "Refresh parameters"\*1

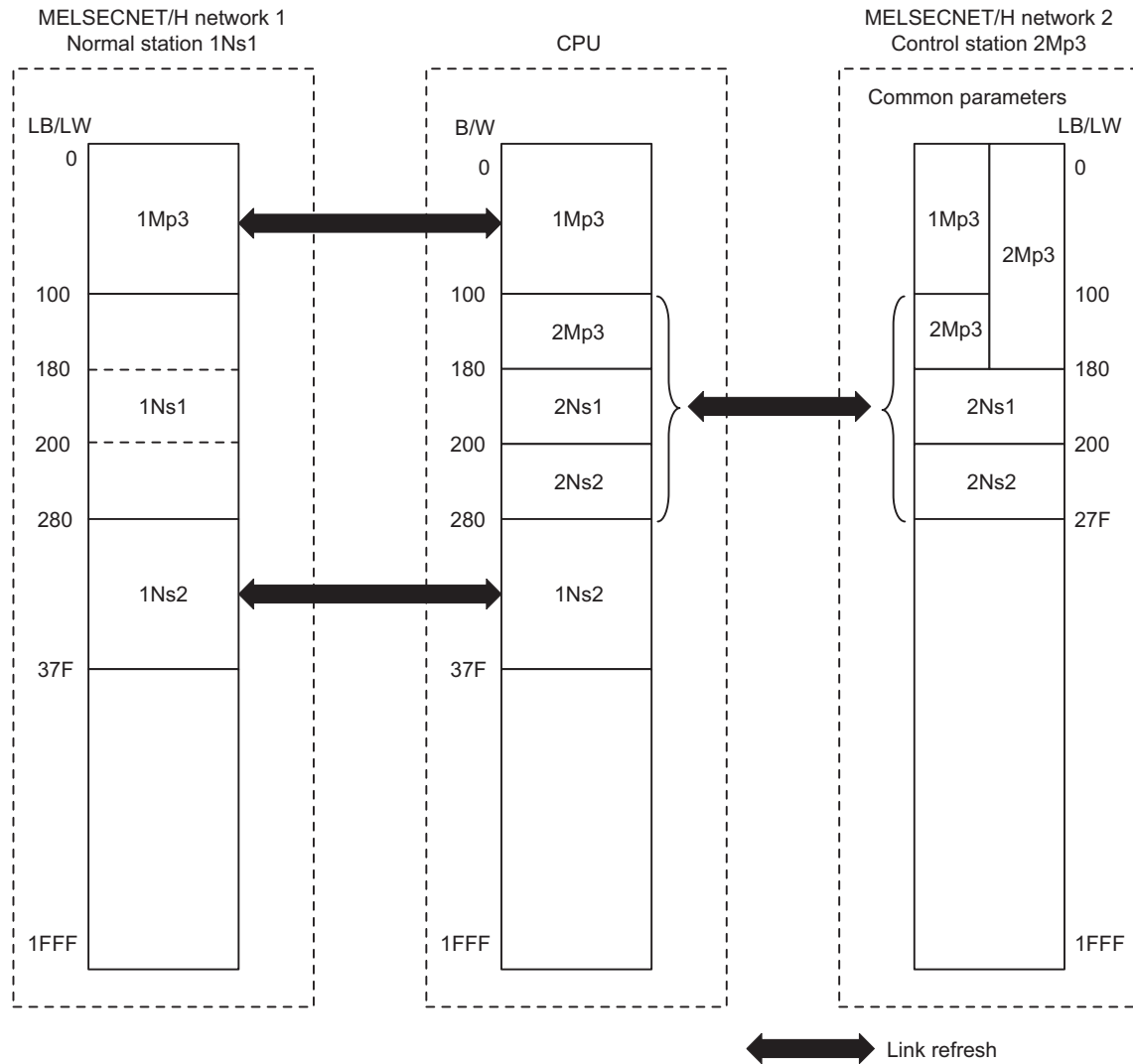

\*1 Set not to duplicate B/W on the CPU.

\*2 Perform the LB/LW assignment for network 2 control station 2Mp3 including the same LB/LW area as that of 1Mp3 to relay network 1 control station 1Mp3.

The following describes the network parameter setting of MELSECNET/H network 1 normal station 1Ns1/network 2 control station 2Mp3 (Q06UDVCPU).

1) Network parameter setting (Q06UDVCPU: MELSECNET/H network 1 normal station 1Ns1/network 2 control station 2Mp3)

	Module 1	Module 2	Module 3	Module 4
Network Type	MNET/H Mode(Normal Station)	MNET/H Mode(Control Station)	None	None
Start I/O No.	0000	0020		
Network No.	1	2		
Total Stations		3		
Group No.	0	0		
Station No.				
Mode	Online	Online		
		Network Range Assignment		
	Station Inherent Parameters			
	Refresh Parameters	Refresh Parameters		
	Interrupt Settings	Interrupt Settings		
		Return as Control Station		
		Optical/Coaxial		

2) Refresh parameter (Q06UDVCPU: MELSECNET/H network 1 normal station 1Ns1)

Assignment Method:  Points/Start  Start/End

Transient Transmission Error History Status:  Overwrite  Hold

	Link Side				↔	PLC Side			
	Dev. Name	Points	Start	End		Dev. Name	Points	Start	End
Transfer SB	SB	512	0000	01FF	↔	SB	512	0000	01FF
Transfer SW	SW	512	0000	01FF	↔	SW	512	0000	01FF
Random Cyclic	LB				↔				
Random Cyclic	LW				↔				
Transfer 1	LB	256	0000	00FF	↔	B	256	0000	00FF
Transfer 2	LB	256	0280	037F	↔	B	256	0280	037F
Transfer 3	LW	256	0000	00FF	↔	W	256	000000	0000FF
Transfer 4	LW	256	0280	037F	↔	W	256	000280	00037F
Transfer 5					↔				
Transfer 6					↔				

\* MELSECNET diagnostics may not be displayed correctly although END processing time of CPU is shortened when the points of SB transfer/SW transfer are reduced.

3) Network range assignment (Q06UDVCPU: MELSECNET/H network 2 control station 2Mp3)

Set up common and station inherent parameters.

Assignment Method:  Points/Start  Start/End

Monitoring Time: 200 X 10ms

Parameter Name:

Total Slave Stations: 3

Switch Screens: LB/LW Setting

Station No.	Send Range for each Station LB			Send Range for each Station LW			Send Range for each Station Low Speed LB			Send Range for each Station Low Speed LW			Pairing
	Points	Start	End	Points	Start	End	Points	Start	End	Points	Start	End	
1	128	0180	01FF	128	0180	01FF							Disable
2	128	0200	027F	128	0200	027F							Disable
3	384	0000	017F	384	0000	017F							Disable



### 4) Refresh parameter (Q06UDVCPUCPU: MELSECNET/H network 2 control station 2Mp3)

Assignment Method  
 Points/Start  
 Start/End

Transient Transmission Error History Status  
 Overwrite    Hold

	Link Side					PLC Side			
	Dev. Name	Points	Start	End		Dev. Name	Points	Start	End
Transfer SB	SB	512	0000	01FF	↔	SB	512	0200	03FF
Transfer SW	SW	512	0000	01FF	↔	SW	512	0200	03FF
Random Cyclic	LB				↔	▼			
Random Cyclic	LW				↔	▼			
Transfer 1	LB ▼	384	0100	027F	↔	B ▼	384	0100	027F
Transfer 2	LW ▼	384	0100	027F	↔	W ▼	384	000100	00027F
Transfer 3	▼				↔	▼			
Transfer 4	▼				↔	▼			
Transfer 5	▼				↔	▼			
Transfer 6	▼				↔	▼			

\* MELSECNET diagnostics may not be displayed correctly although END processing time of CPU is shortened when the points of SB transfer/SW transfer are reduced.

**(h) MELSECNET/H network 1 normal station 1Ns1/network 2 control station 2Mp3 (Inter-link data transfer of gateway station)**

For data transfer between MELSECNET/H networks 1 and 2, change the setting of MELSECNET (II) 2 and 3-tier by:

- Transferring the data between networks 1 and 2 by the setting of “Interlink transmission parameters” between gateway stations 1Ns1 and 2Mp3

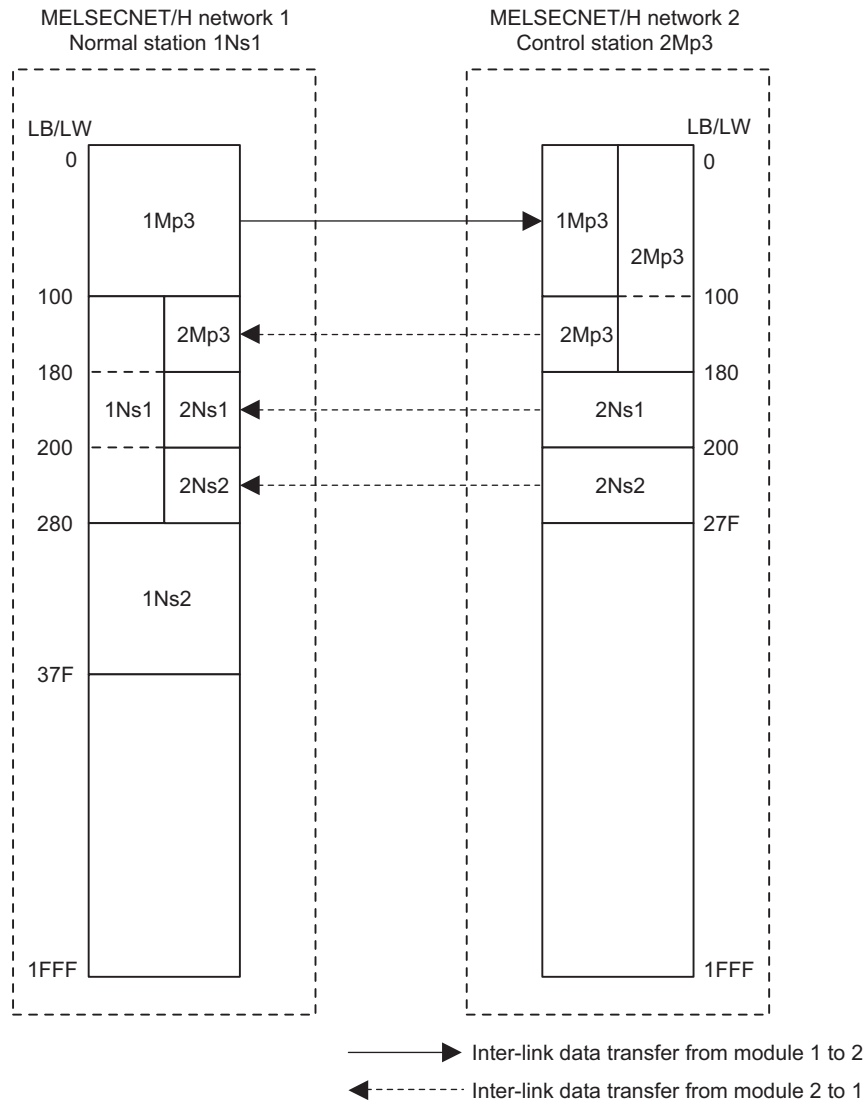

The following describes the inter-link data transfer setting of MELSECNET/H network 1 normal station 1Ns1/network 2 control station 2Mp3 (Q06UDVCPU).

- 1) Inter-link data transfer parameter (Q06UDVCPU: MELSECNET/H network 1 normal station 1Ns1/network 2 control station 2Mp3)

Assignment Method  
 Points/Start  Start/End

Transfer from: Module 1:MNET/H Mode(Normal Station)  
 Transfer to: Module 2:MNET/H Mode(Control Station)

No.	LB						LW					
	Transfer from			Transfer to			Transfer from			Transfer to		
	Points	Start	End	Points	Start	End	Points	Start	End	Points	Start	End
1	256	0000	00FF	256	0000	00FF	256	0000	00FF	256	0000	00FF
2												
3												
4												
5												
6												
7												
8												
9												
10												
11												

Transfer to link device must be set within the host station send range of the target network module.  
 The range of Transfer to link device cannot be set in the link refresh range.

Assignment Method  
 Points/Start  Start/End

Transfer from: Module 2:MNET/H Mode(Control Station)  
 Transfer to: Module 1:MNET/H Mode(Normal Station)

No.	LB						LW					
	Transfer from			Transfer to			Transfer from			Transfer to		
	Points	Start	End	Points	Start	End	Points	Start	End	Points	Start	End
1	384	0100	027F	384	0100	027F	384	0100	027F	384	0100	027F
2												
3												
4												
5												
6												
7												
8												
9												
10												
11												

Transfer to link device must be set within the host station send range of the target network module.  
 The range of Transfer to link device cannot be set in the link refresh range.

**(i) MELSECNET/H network 2 normal station 2Ns1, 2Ns2**

For MELSECNET/H network 2 normal stations 2Ns1 and 2Ns2, change the settings by:

- Performing B/W refreshment by the setting of "Refresh parameters"

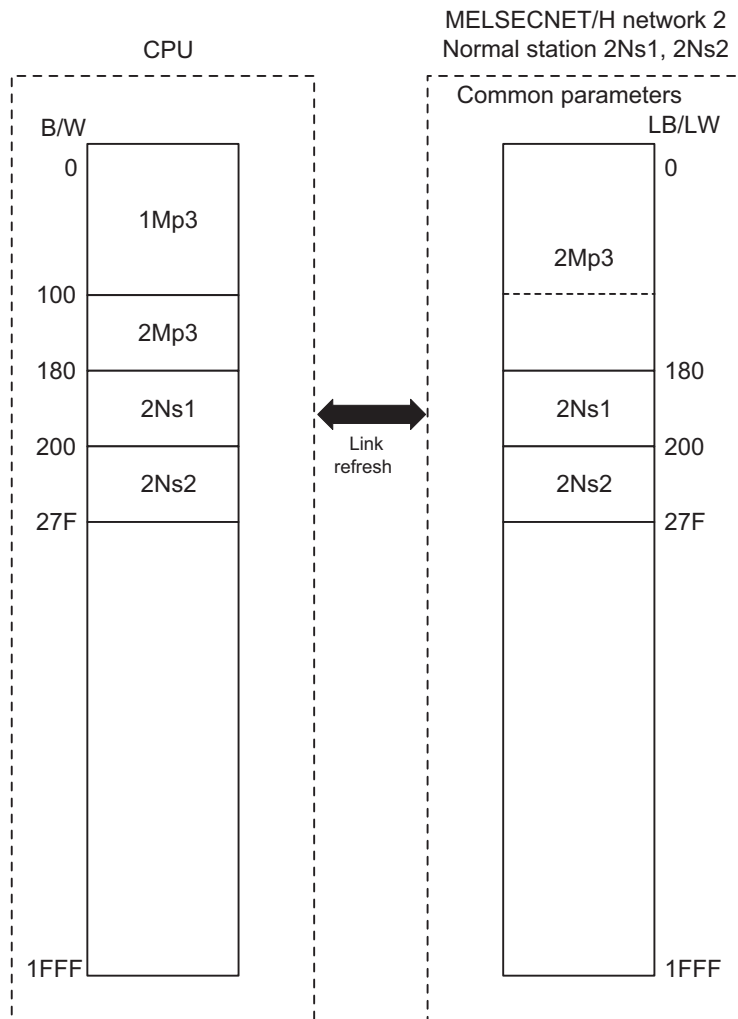

The following describes the network parameter setting of MELSECNET/H network 2 normal stations 2Ns1, 2Ns2 (Q02UCPU).

1) Network parameter setting (Q02UCPU: MELSECNET/H network 2 normal stations 2Ns1, 2Ns2)

	Module 1	Module 2	Module 3	Module 4
Network Type	MNET/H Mode(Normal Station)	None	None	None
Start I/O No.	0000			
Network No.	2			
Total Stations				
Group No.	0			
Station No.				
Mode	Online			
	Station Inherent Parameters			
	Refresh Parameters			
	Interrupt Settings			

2) Refresh parameter (Q02UCPU: MELSECNET/H network 2 normal stations 2Ns1, 2Ns2)

Assignment Method

Points/Start

Start/End

Transient Transmission Error History Status

Overwrite    Hold

	Link Side					PLC Side			
	Dev. Name	Points	Start	End		Dev. Name	Points	Start	End
Transfer SB	SB	512	0000	01FF	↔	SB	512	0000	01FF
Transfer SW	SW	512	0000	01FF	↔	SW	512	0000	01FF
Random Cyclic	LB				↔				
Random Cyclic	LW				↔				
Transfer 1	LB	640	0000	027F	↔	B	640	0000	027F
Transfer 2	LW	640	0000	027F	↔	W	640	000000	00027F
Transfer 3					↔				
Transfer 4					↔				
Transfer 5					↔				
Transfer 6					↔				

\* MELSECNET diagnostics may not be displayed correctly although END processing time of CPU is shortened when the points of SB transfer/SW transfer are reduced.

### 2.5.4 Example of changing parameters on 3-tier system (When the first half/second half of link parameter is set)

The following shows how to change network parameter on LB/LW, when replacing the MELSECNET II 3-tier system with MELSECNET/H. Network range assignment of the present MELSECNET II 3-tier system is used as it is for replacement with MELSECNET/H.

MELSECNET II 2-tier is replaced with the network 1 of MELSECNET/H, and 3-tier is replaced with the network 2. The MELSECNET II master station is replaced with the MELSECNET/H control station, and MELSECNET II local stations are replaced with MELSECNET/H normal stations.

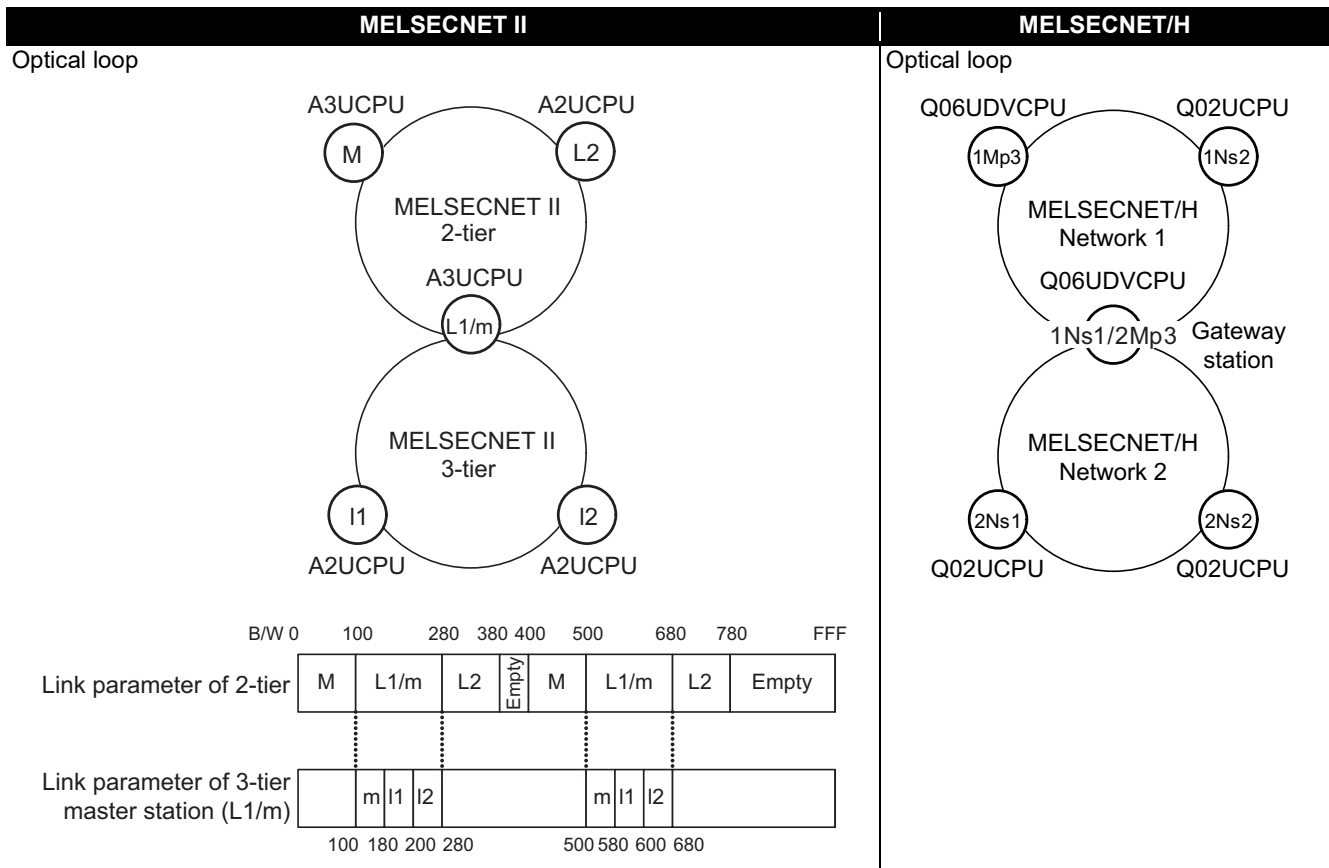

**Concept of MELSECNET II 3-tier system replacement****Step 1: Control station (1Mp3) setting**

Set the link parameter setting on MELSECNET II 2-tier master station as MELSECNET/H network 1 control station 1Mp3.

- In "Network range assignment (Common parameters)" of control station 1Mp3, set the LB/LW (first half size + second half size) as a contiguous area on each station.
- It is divided into the first half LB/LW and the second half LB/LW, and transferred depending on the settings 1 and 2 of "Station inherent parameter".

**Step 2: Common parameter and refresh parameter settings of gateway station (1Ns1/2Mp3)**

"Common parameter" setting and "Refresh parameter setting" of the MELSECNET II 3-tier master station are set as MELSECNET/H network 2 control station 2Mp3 and network 1 normal station 1Ns1.

- In "Network range assignment (Common parameters)" of control station 2Mp3, set the LB/LW (first half size + second half size) as a contiguous area on each station.  
The range assignment should be performed including the same LB/LW size as that of 1Mp3 to relay 1Mp3.
- Set "Refresh parameter" to transfer B/W by dividing it into the first half B/W and the second half B/W on each station of network 2 control station 2Mp3 and network 1 normal station 1Ns1.  
Make sure that B/W of networks 1 and 2 will not duplicate on the CPU.
- As "Interlink transmission parameters" parameter the gateway station 1Ns1/2Mp3 is set for, do not set a station inherent parameter.

**Step 3: Inter-link data transfer setting of gateway station (1Ns1/2Mp3)**

Data transfer between 2 and 3-tier, which is performed automatically on MELSECNET II, is performed by Inter-link data transfer on gateway station 1Ns1/2Mp3.

- LB/LW area shared by networks 1 and 2 is set by "Interlink transmission parameters" parameter of gateway station between 1Ns1 and 2Mp3.

**Step 4: Station setting other than gateway stations (1Ns2, 2Ns1, 2Ns2)**

"Station inherent parameter" and "Refresh parameters" of stations excluding gateway stations (1Ns2, 2Ns1, 2Ns2) are set.

- Set "Station inherent parameter" of network 1 normal station 1Ns2 as the same setting as that of network 1 control station 1Mp3.
- Set "Station inherent parameter" of network 2 normal station 2Ns2 as the same setting as that of network 2 normal station 2Ns1.
- Set "Refresh parameter" to refresh all area of common parameters assigned on control stations.

Data flow between each station of MELSECNET/H is shown at next page.

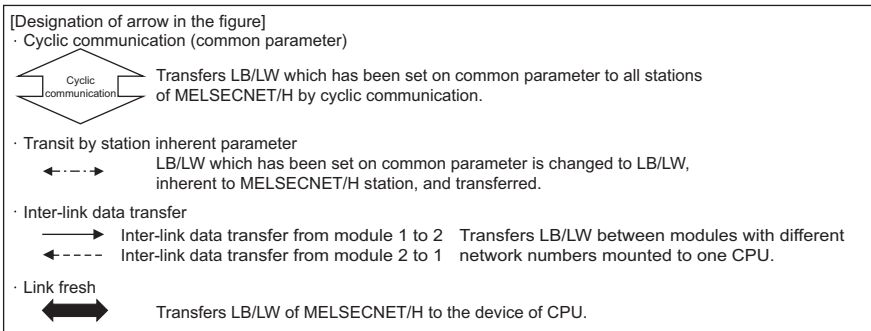
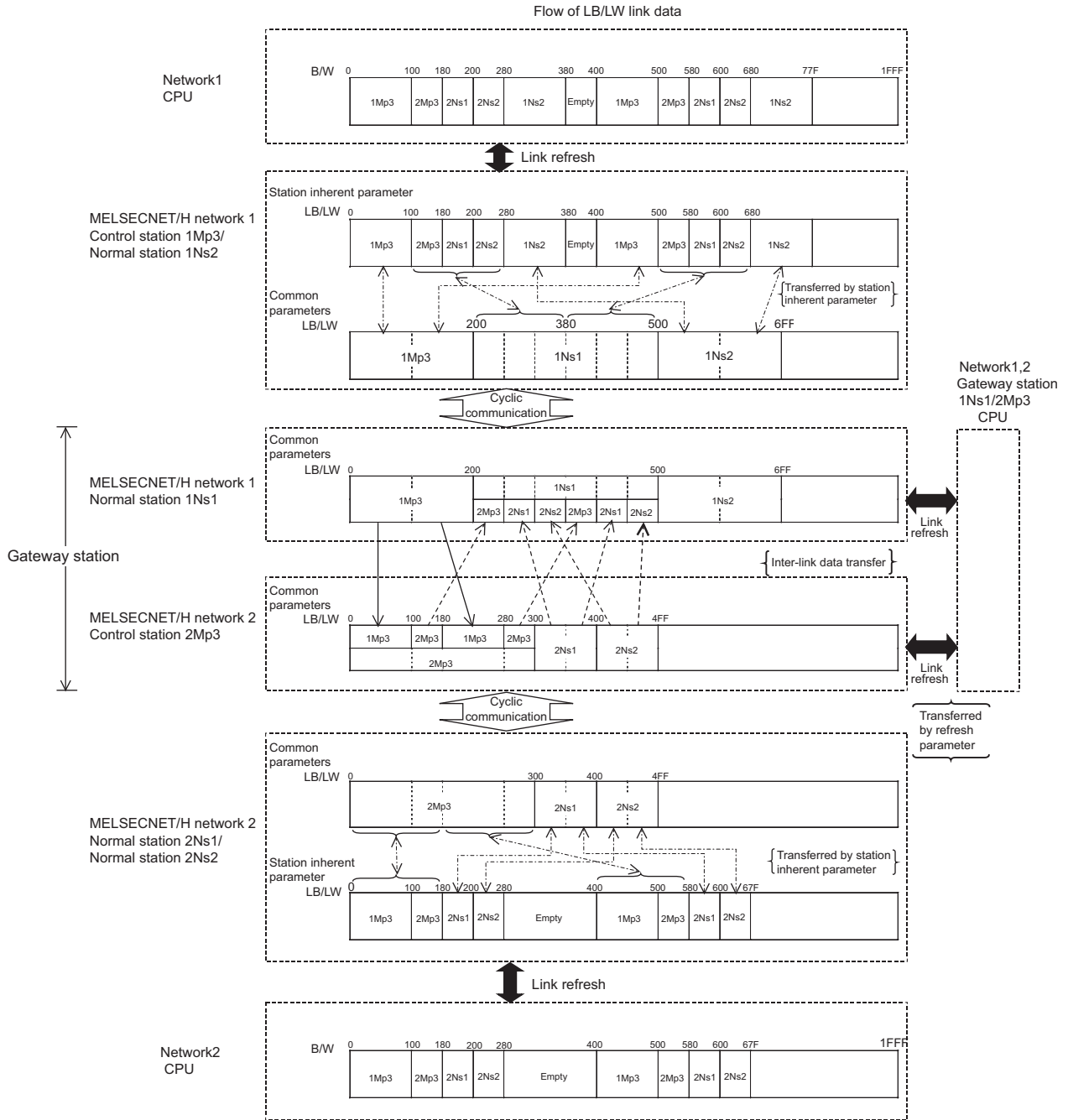



Network parameter setting is required for control and normal stations on MELSECNET/H.

The following shows parameters required on each station of MELSECNET/H.

	Common parameter (Network range assignment)	Station inherent parameter	Refresh parameter	Inter-link data transfer
1Mp3	○ (Refer to example in (e) 2))	○ (Refer to example in (e) 3))	△ (Refer to example in (e) 4))	
1Ns2		○ (Refer to example in (f) 2))	△ (Refer to example in (f) 3))	
1Ns1		-	○ (Refer to example in (g) 3))	○ (Refer to example in (g) 5))
2Mp3	○ (Refer to example in (g) 2))	-	○ (Refer to example in (g) 4))	
2Ns1		○ (Refer to example in (h) 2))	△ (Refer to example in (h) 3))	
2Ns2		○ (Refer to example in (h) 2))	△ (Refer to example in (h) 3))	

○: Setting required/ △: Setting required (Default setting is also acceptable)/ - Setting not required

### (a) MELSECNET II 2-tier master station M

The following describes the network parameter setting of MELSECNET II 2-tier master station M (A3UCPU).

#### 1) Network parameter setting (A3UCPU: MELSECNET II 2-tier master station M)

	Module No.1	Module No.2	Module No.3	Module No.4
Network type	MNET II (Master station)	None	None	None
Start I/O No.	0000			
Network No.				
Total stations	2			
Group No.				
Station No.				

Network range assignment

Refresh parameters

Necessary setting: No setting / Already set | Set if it is needed: No setting / Already set

Start I/O No.: Input the start I/O No. installed in the module in 16-point unit. Valid module during other station access: 1

Interlink transmission parameters

Acknowledge XY assignment | Routing parameters | Check | End | Cancel

#### 2) Network range assignment (A3UCPU: MELSECNET II 2-tier master station M)

Setup common parameters

Assignment method:  Points/Start,  Start/End

Monitoring time: 200 × 10ms

Total slave stations: 2

Switch screens: LB/LW settings

L/R station No.	Send range for each station			Send range for each station			Send range for each station			Send range for each station		
	First half LB			First half LW			Second half LB			Second half LW		
	Points	Start	End	Points	Start	End	Points	Start	End	Points	Start	End
M 0	256	0000	00FF	256	0000	00FF	256	0400	04FF	256	0400	04FF
II L 1	384	0100	027F	384	0100	027F	384	0500	067F	384	0500	067F
II L 2	256	0280	037F	256	0280	037F	256	0680	077F	256	0680	077F

#### 3) Refresh parameter (A3UCPU: MELSECNET II 2-tier master station M)

Assignment method:  Points/Start,  Start/End

Transient transmission error history status:  Overwrite,  Hold

	Link side				PLC side			
	Points	Start	End		BlockNo.	Points	Start	End
LB<->B transmission(1)	1920	0000	077F	↔		1920	0000	077F
LW<->W transmission(1)	1920	0000	077F	↔		1920	0000	077F
LX/LY<->XY transmission	2048	0000	07FF	↔		2048	0000	07FF

### (b) MELSECNET II 2-tier local station L2

As the cyclic communication is performed according to the network range assignments of the 2-tier master station (A3UCPU), there is no parameter setting for network range assignment on 2-tier local stations.

### (c) MELSECNET II 2-tier local station L1/3-tier master station m (gateway station)

The following describes the network parameter settings of MELSECNET II 2-tier local station L1/3-tier master station m (A3UCPU).

1) Network parameter setting (A3UCPU: MELSECNET II 2-tier local station L1/3-tier master station m)

	Module No.1	Module No.2	Module No.3	Module No.4
Network type	MNET II (Local station)	MNET II (Master station)	None	None
Start I/O No.	0000	0020		
Network No.				
Total stations		2		
Group No.				
Station No.				
		Network range assignment		
		Refresh parameters		

Necessary setting[ No setting / Already set ] Set if it is needed[ No setting / Already set ]

Start I/O No.: Valid module during other station access 1

Interlink transmission parameters Routing parameters Check End Cancel

2) Network range assignment (A3UCPU: MELSECNET II 3-tier master station m)

Setup common parameters

Assignment method:  Points/Start  Start/End

Monitoring time: 200 × 10ms

Total slave stations: 2

Switch screens: LB/LW settings

L/R station No.	Send range for each station			Send range for each station			Send range for each station			Send range for each station		
	First half LB			First half LW			Second half LB			Second half LW		
	Points	Start	End	Points	Start	End	Points	Start	End	Points	Start	End
M 0	128	0100	017F	128	0100	017F	128	0500	057F	128	0500	057F
II L 1	128	0180	01FF	128	0180	01FF	128	0580	05FF	128	0580	05FF
II L 2	128	0200	027F	128	0200	027F	128	0600	067F	128	0600	067F

3) Refresh parameter (A3UCPU: MELSECNET II 3-tier master station m)

Assignment method:  Points/Start  Start/End

Transient transmission error history status:  Overwrite  Hold

	Link side				PLC side			
	Points	Start	End		BlockNo.	Points	Start	End
LB<->B transmission(1)	1920	0000	077F	↔		1920	0000	077F
LW<->W transmission(1)	1920	0000	077F	↔		1920	0000	077F
LX/LY<->X/Y transmission	2048	0000	07FF	↔		2048	0000	07FF

### (d) MELSECNET II 3-tier local station I1, I2

As the cyclic communication is performed according to the network range assignments of the 3-tier master station (A3UCPU), there is no parameter setting for network range assignment on 3-tier local stations.

(e) MELSECNET/H network 1 control station 1Mp3

For MELSECNET/H network 1 control station 1Mp3, change the settings of MELSECNET II 2-tier first half/second half setting by:

- Assigning LB/LW (first half + second half size) to each station by the setting of "Network range assignment (Common parameters)"
- Dividing the data into the first half LB/LW and second half LB/LW and transferring them by the setting of "Setting1" and "Setting2" of "Station inherent parameter"

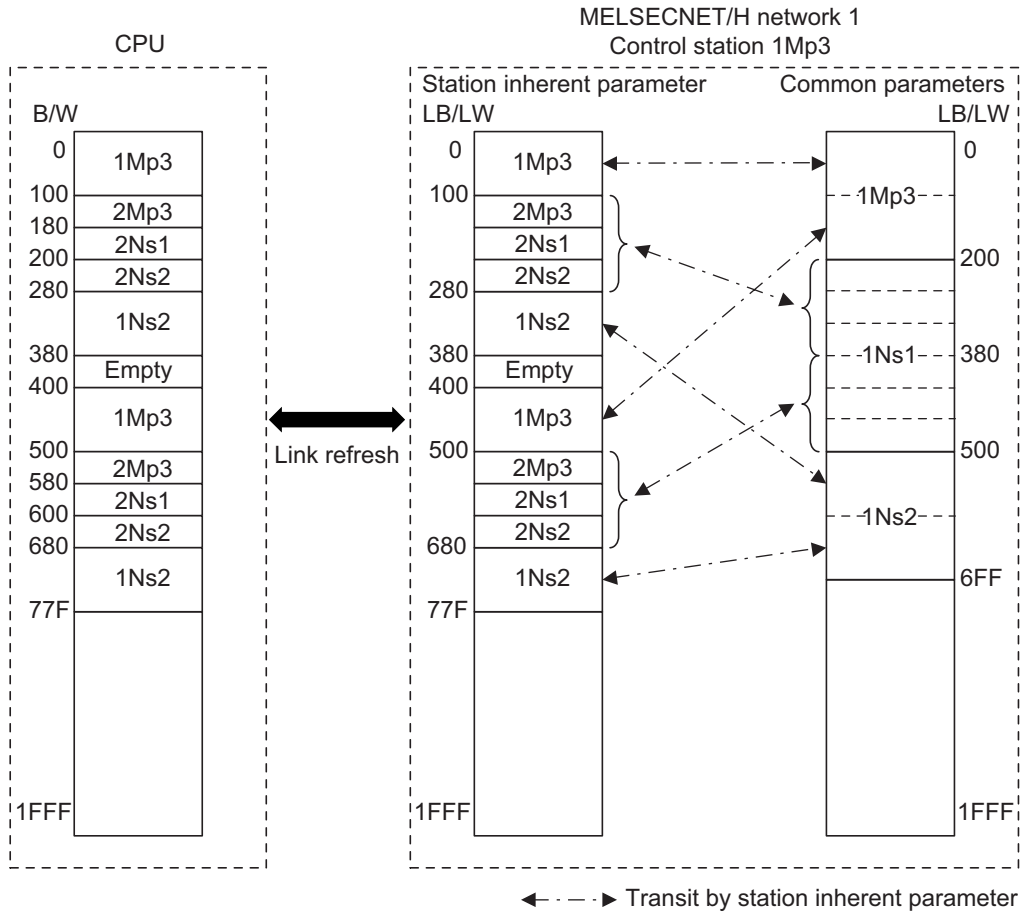

The following describes the network parameter setting of MELSECNET/H network 1 control station 1Mp3 (Q06UDVCPU).

1) Network parameter setting (Q06UDVCPU: MELSECNET/H network 1 control station 1Mp3)

	Module 1	Module 2	Module 3	Module 4
Network Type	MNET/H Mode(Control Station)	None	None	None
Start I/O No.	0000			
Network No.	1			
Total Stations	3			
Group No.	0			
Station No.				
Mode	Online			
	Network Range Assignment			
	Refresh Parameters			
	Interrupt Settings			
	Return as Control Station			
	Optical/Coaxial			

2) Network range assignment (Q06UDVCPU: MELSECNET/H network 1 control station 1Mp3)

Set up common and station inherent parameters.

Assignment Method:  
 Points/Start  
 Start/End

Monitoring Time:  X 10ms  
 Parameter Name:

Total Slave Stations:   
 Switch Screens:

Station No.	Send Range for each Station LB			Send Range for each Station LW			Send Range for each Station Low Speed LB			Send Range for each Station Low Speed LW			Pairing
	Points	Start	End	Points	Start	End	Points	Start	End	Points	Start	End	
1	768	0200	04FF	768	0200	04FF							Disable
2	512	0500	06FF	512	0500	06FF							Disable
3	512	0000	01FF	512	0000	01FF							Disable

3) Station inherent parameter (Q06UDVCPU: MELSECNET/H network 1 control station 1Mp3)

Reference Network Range Assignment

Workspace Location:

Workspace Name:

Project Name:  Board No.:

Reference Read Cancel

Assignment Method

Points/Start

Start/End

Parameter Name:

Switch Screens: LB Setting

Station No.	Setting 1			Setting 2			Network Range Assignment			Pairing
	Points	Start	End	Points	Start	End	Points	Start	End	
1	384	0100	027F	384	0500	067F	768	0200	04FF	Disable
2	256	0280	037F	256	0680	077F	512	0500	06FF	Disable
3	256	0000	00FF	256	0400	04FF	512	0000	01FF	Disable

Reference Network Range Assignment

Workspace Location:

Workspace Name:

Project Name:  Board No.:

Reference Read Cancel

Assignment Method

Points/Start

Start/End

Parameter Name:

Switch Screens: LW Setting

Station No.	Setting 1			Setting 2			Network Range Assignment			Pairing
	Points	Start	End	Points	Start	End	Points	Start	End	
1	384	0100	027F	384	0500	067F	768	0200	04FF	Disable
2	256	0280	037F	256	0680	077F	512	0500	06FF	Disable
3	256	0000	00FF	256	0400	04FF	512	0000	01FF	Disable

4) Refresh parameter (Q06UDVCPU: MELSECNET/H network 1 control station 1Mp3)

Assignment Method

Points/Start

Start/End

Transient Transmission Error History Status

Overwrite  Hold

	Link Side					PLC Side			
	Dev. Name	Points	Start	End		Dev. Name	Points	Start	End
Transfer SB	SB	512	0000	01FF	↔	SB	512	0000	01FF
Transfer SW	SW	512	0000	01FF	↔	SW	512	0000	01FF
Random Cyclic	LB				↔				
Random Cyclic	LW				↔				
Transfer 1	LB	1920	0000	077F	↔	B	1920	0000	077F
Transfer 2	LW	1920	0000	077F	↔	W	1920	000000	00077F
Transfer 3					↔				
Transfer 4					↔				
Transfer 5					↔				
Transfer 6					↔				

\* MELSECNET diagnostics may not be displayed correctly although END processing time of CPU is shortened when the points of SB transfer/SW transfer are reduced.

### (f) MELSECNET/H network 1 normal station 1Ns2

For MELSECNET/H network 1 normal station 1Ns2 that is not gateway station, change the settings of MELSECNET II 2-tier first half/second half setting by:

- Dividing the data into the first half LB/LW and second half LB/LW and transferring them by setting of "Setting1" and "Setting2" of "Station inherent parameter"

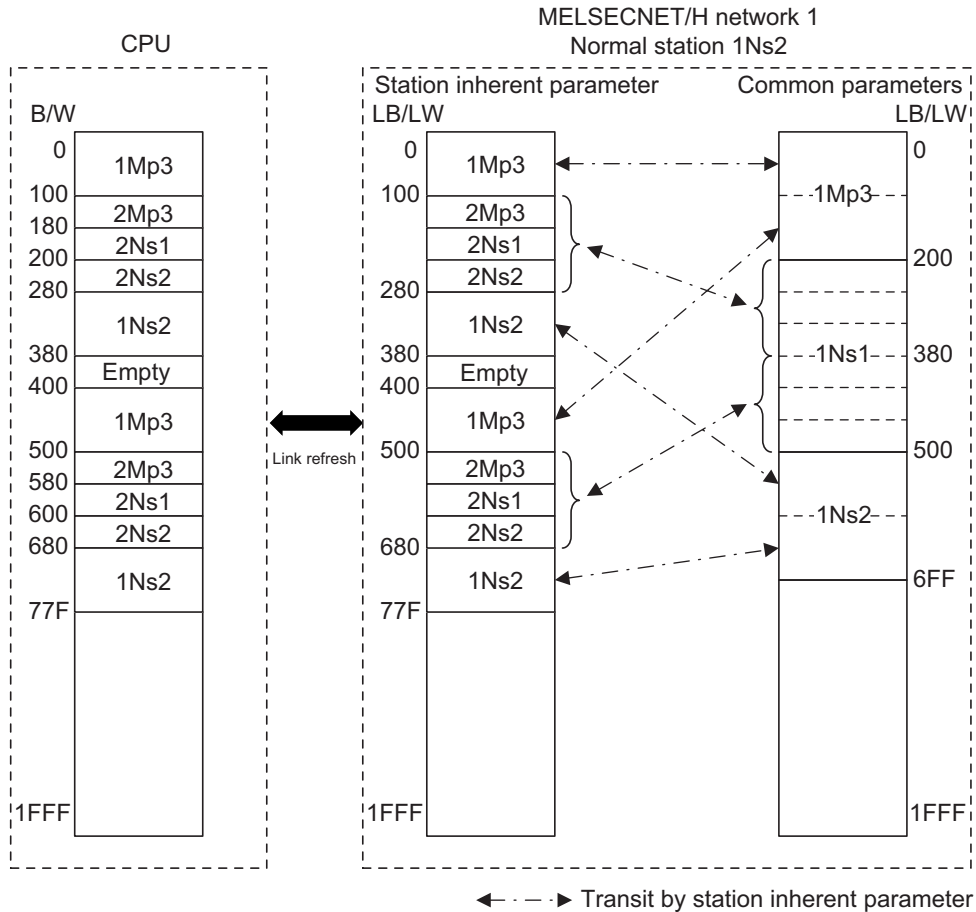

The following describes the network parameter setting of MELSECNET/H network 1 normal station 1Ns2 (Q02UCPU).

### 1) Network parameter setting (Q02UCPU: MELSECNET/H network 1 normal station 1Ns2)

	Module 1	Module 2	Module 3	Module 4
Network Type	MNET/H Mode(Normal Station)	None	None	None
Start I/O No.	0000			
Network No.	1			
Total Stations				
Group No.	0			
Station No.				
Mode	Online			
	Station Inherent Parameters			
	Refresh Parameters			
	Interrupt Settings			

### 2) Station inherent parameter (Q02UCPU: MELSECNET/H network 1 normal station 1Ns2)

Reference Network Range Assignment

Workspace Location: C:\MELSEC\gppw\

Workspace Name:

Project Name: Q06UDVCPU\_ Board No. 1

Reference Read Cancel

Assignment Method:

Points/Start

Start/End

Parameter Name:

Switch Screens: LB Setting

Station No.	Setting 1			Setting 2			Network Range Assignment			Pairing
	Points	Start	End	Points	Start	End	Points	Start	End	
1	384	0100	027F	384	0500	067F	768	0200	04FF	Disable
2	256	0280	037F	256	0680	077F	512	0500	06FF	Disable
3	256	0000	00FF	256	0400	04FF	512	0000	01FF	Disable

Reference Network Range Assignment

Workspace Location: C:\MELSEC\gppw\

Workspace Name:

Project Name: Q06UDVCPU\_ Board No. 1

Reference Read Cancel

Assignment Method:

Points/Start

Start/End

Parameter Name:

Switch Screens: LW Setting

Station No.	Setting 1			Setting 2			Network Range Assignment			Pairing
	Points	Start	End	Points	Start	End	Points	Start	End	
1	384	0100	027F	384	0500	067F	768	0200	04FF	Disable
2	256	0280	037F	256	0680	077F	512	0500	06FF	Disable
3	256	0000	00FF	256	0400	04FF	512	0000	01FF	Disable



### 3) Refresh parameter (Q02UCPU: MELSECNET/H network 1 normal station 1Ns2)

Assignment Method  
 Points/Start  
 Start/End

Transient Transmission Error History Status  
 Overwrite    Hold

	Link Side					PLC Side			
	Dev. Name	Points	Start	End		Dev. Name	Points	Start	End
Transfer SB	SB	512	0000	01FF	↔	SB	512	0000	01FF
Transfer SW	SW	512	0000	01FF	↔	SW	512	0000	01FF
Random Cyclic	LB				↔	▼			
Random Cyclic	LW				↔	▼			
Transfer 1	LB ▼	1920	0000	077F	↔	B ▼	1920	0000	077F
Transfer 2	LW ▼	1920	0000	077F	↔	W ▼	1920	000000	00077F
Transfer 3	▼				↔	▼			
Transfer 4	▼				↔	▼			
Transfer 5	▼				↔	▼			
Transfer 6	▼				↔	▼			

\* MELSECNET diagnostics may not be displayed correctly although END processing time of CPU is shortened when the points of SB transfer/SW transfer are reduced.

**(g) MELSECNET/H network 1 normal station 1Ns1/network 2 control station 2Mp3 (gateway station)**

For data transfer between MELSECNET/H networks 1 and 2, change the setting of MELSECNET II 2 and 3-tier by:

- Assigning LB/LW of network 2 control station 2Mp3 including LB/LW size of network 1 control station 1Mp3 by the setting of "Network range assignment (Common parameters)" on network 2 control station 2Mp3
- Transferring the data between networks 1 and 2 by the setting of "Interlink transmission parameters" between gateway stations 1Ns1 and 2Mp3

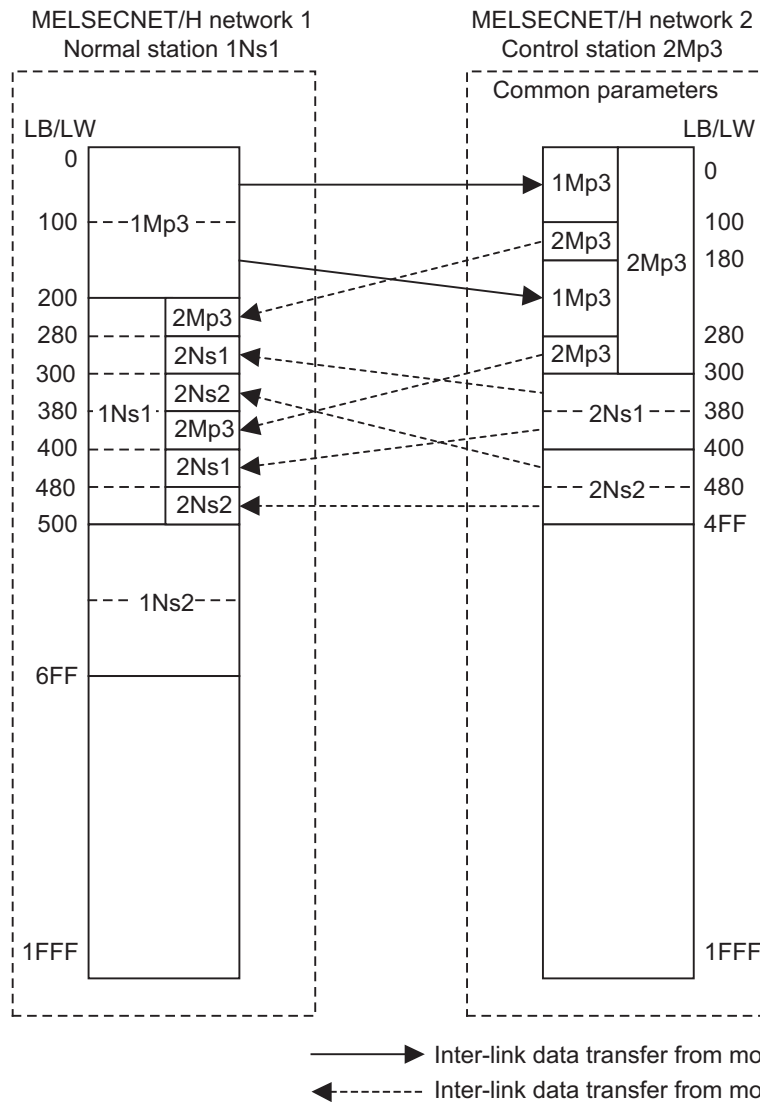

For MELSECNET/H normal station 1Ns1 that is gateway station, change the settings of MELSECNET II 2-tier first half/second half settings by:

- Dividing the data into the first half and second half and refreshing them by the setting of "Refresh parameters"\*1

Also, for MELSECNET/H control station 2Mp3 of gateway station, change the settings of MELSECNET II 3-tier first half/second half settings by:

- Assigning LB/LW (first + last size) to each station by the setting of "Network range assignment (Common parameters)"\*2
- Dividing the data into the first half and second half and refreshing them by the setting of "Refresh parameters"\*1

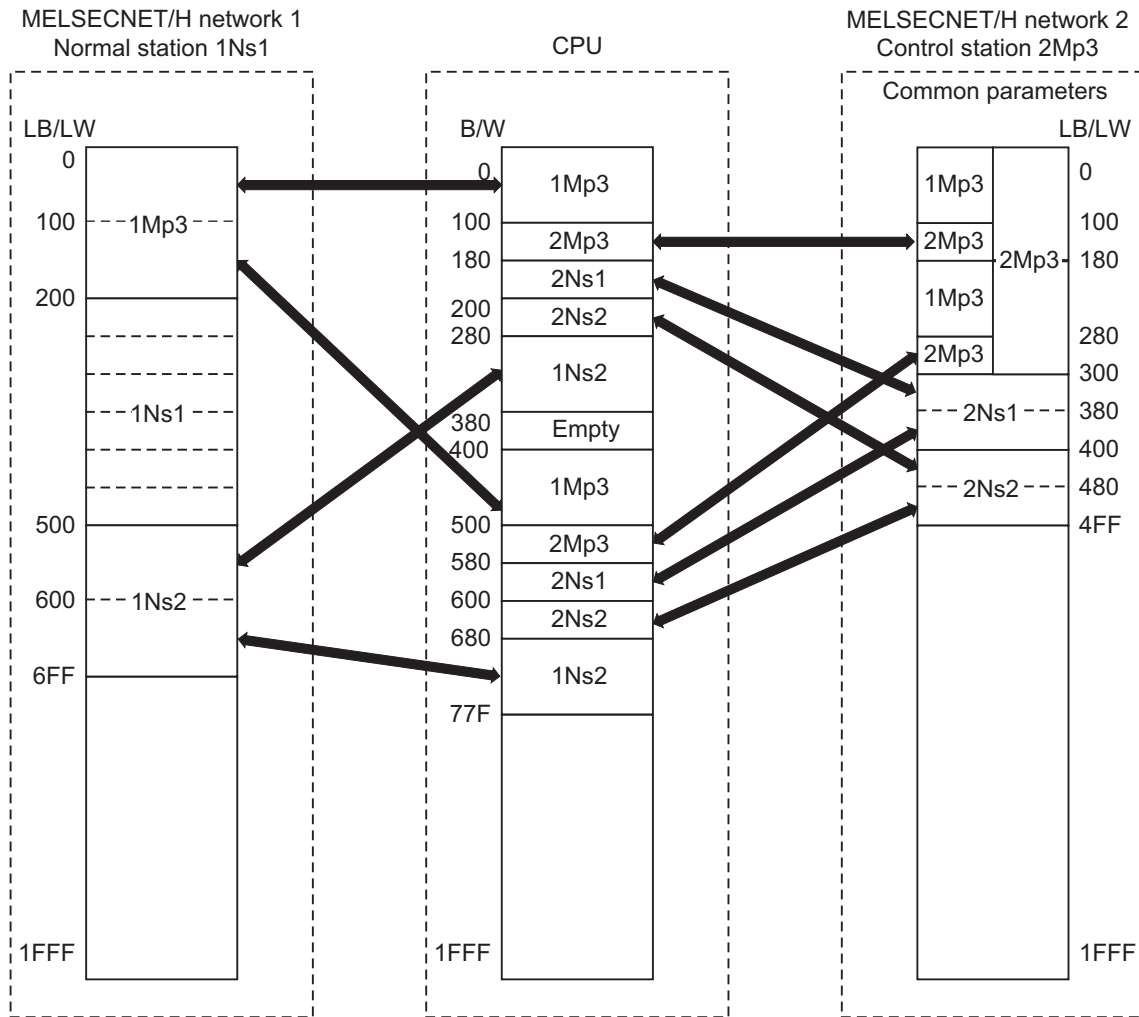

\*1 Set not to duplicate B/W on the CPU.

\*2 Perform the LB/LW assignment for network 2 control station 2Mp3 including the same LB/LW area as that of 1Mp3 to relay network 1 control station 1Mp3.

The following describes the network parameter setting of MELSECNET/H network 1 normal station 1Ns1/network 2 control station 2Mp3 (Q06UDVCPU).

1) Network parameter setting (Q06UDVCPU: MELSECNET/H network 1 normal station 1Ns1/network 2 control station 2Mp3)

	Module 1	Module 2	Module 3	Module 4
Network Type	MNET/H Mode(Normal Station)	MNET/H Mode(Control Station)	None	None
Start I/O No.	0000	0020		
Network No.	1	2		
Total Stations		3		
Group No.	0	0		
Station No.				
Mode	Online	Online		
	Station Inherent Parameters	Network Range Assignment		
	Refresh Parameters	Refresh Parameters		
	Interrupt Settings	Interrupt Settings		
		Return as Control Station		
		Optical/Coaxial		

2) Network range assignment (Q06UDVCPU: MELSECNET/H network 2 control station 2Mp3)

Set up common and station inherent parameters.

Assignment Method  
 Points/Start  
 Start/End

Monitoring Time: 200 X 10ms  
 Parameter Name:

Total Slave Stations: 3  
 Switch Screens: LB/LW Setting

Station No.	Send Range for each Station LB			Send Range for each Station LW			Send Range for each Station Low Speed LB			Send Range for each Station Low Speed LW			Pairing
	Points	Start	End	Points	Start	End	Points	Start	End	Points	Start	End	
1	256	0300	03FF	256	0300	03FF							Disable
2	256	0400	04FF	256	0400	04FF							Disable
3	768	0000	02FF	768	0000	02FF							Disable

### 3) Refresh parameter (Q06UDVCPU: MELSECNET/H network 1 normal station 1Ns1)

Assignment Method

 Points/Start  
 Start/End

Transient Transmission Error History Status

 Overwrite    Hold

	Link Side				↔	PLC Side			
	Dev. Name	Points	Start	End		Dev. Name	Points	Start	End
Transfer SB	SB	512	0000	01FF	↔	SB	512	0000	01FF
Transfer SW	SW	512	0000	01FF	↔	SW	512	0000	01FF
Random Cyclic	LB				↔				
Random Cyclic	LW				↔				
Transfer 1	LB	256	0000	00FF	↔	B	256	0000	00FF
Transfer 2	LB	256	0100	01FF	↔	B	256	0400	04FF
Transfer 3	LB	256	0500	05FF	↔	B	256	0280	037F
Transfer 4	LB	256	0600	06FF	↔	B	256	0680	077F
Transfer 5	LW	256	0000	00FF	↔	W	256	000000	0000FF
Transfer 6	LW	256	0100	01FF	↔	W	256	000400	0004FF
Transfer 7	LW	256	0500	05FF	↔	W	256	000280	00037F
Transfer 8	LW	256	0600	06FF	↔	W	256	000680	00077F
Transfer 9					↔				

\* MELSECNET diagnostics may not be displayed correctly although END processing time of CPU is shortened when the points of SB transfer/SW transfer are reduced.

### 4) Refresh parameter (Q06UDVCPU: MELSECNET/H network 2 control station 2Mp3)

Assignment Method

 Points/Start  
 Start/End

Transient Transmission Error History Status

 Overwrite    Hold

	Link Side				↔	PLC Side			
	Dev. Name	Points	Start	End		Dev. Name	Points	Start	End
Transfer SB	SB	512	0000	01FF	↔	SB	512	0200	03FF
Transfer SW	SW	512	0000	01FF	↔	SW	512	0200	03FF
Random Cyclic	LB				↔				
Random Cyclic	LW				↔				
Transfer 1	LB	128	0100	017F	↔	B	128	0100	017F
Transfer 2	LB	128	0280	02FF	↔	B	128	0500	057F
Transfer 3	LB	128	0300	037F	↔	B	128	0180	01FF
Transfer 4	LB	128	0380	03FF	↔	B	128	0580	05FF
Transfer 5	LB	128	0400	047F	↔	B	128	0200	027F
Transfer 6	LB	128	0480	04FF	↔	B	128	0600	067F
Transfer 7	LW	128	0100	017F	↔	W	128	000100	00017F
Transfer 8	LW	128	0280	02FF	↔	W	128	000500	00057F
Transfer 9	LW	128	0300	037F	↔	W	128	000180	0001FF
Transfer 10	LW	128	0380	03FF	↔	W	128	000580	0005FF
Transfer 11	LW	128	0400	047F	↔	W	128	000200	00027F
Transfer 12	LW	128	0480	04FF	↔	W	128	000600	00067F
Transfer 13					↔				

\* MELSECNET diagnostics may not be displayed correctly although END processing time of CPU is shortened when the points of SB transfer/SW transfer are reduced.

5) Inter-link data transfer parameter (Q06UDVCPU: MELSECNET/H network 1 normal station 1Ns1/network 2 control station 2Mp3)

Assignment Method  
 Points/Start  Start/End

Transfer from   
 Transfer to

No.	LB						LW					
	Transfer from			Transfer to			Transfer from			Transfer to		
	Points	Start	End	Points	Start	End	Points	Start	End	Points	Start	End
1	256	0000	00FF	256	0000	00FF	256	0000	00FF	256	0000	00FF
2	256	0100	01FF	256	0180	027F	256	0100	01FF	256	0180	027F
3												
4												
5												
6												
7												
8												
9												
10												
11												

Assignment Method  
 Points/Start  Start/End

Transfer from   
 Transfer to

No.	LB						LW					
	Transfer from			Transfer to			Transfer from			Transfer to		
	Points	Start	End	Points	Start	End	Points	Start	End	Points	Start	End
1	128	0100	017F	128	0200	027F	128	0100	017F	128	0200	027F
2	128	0280	02FF	128	0380	03FF	128	0280	02FF	128	0380	03FF
3	128	0300	037F	128	0280	02FF	128	0300	037F	128	0280	02FF
4	128	0380	03FF	128	0400	047F	128	0380	03FF	128	0400	047F
5	128	0400	047F	128	0300	037F	128	0400	047F	128	0300	037F
6	128	0480	04FF	128	0480	04FF	128	0480	04FF	128	0480	04FF
7												
8												
9												
10												
11												

### (h) MELSECNET/H network 2 normal station 2Ns1, 2Ns2

For MELSECNET/H network 2 normal station 2Ns1, 2Ns2 that is not gateway station, change the settings of MELSECNET II 2-tier first half/second half setting by:

- Dividing the data into the first half LB/LW and second half LB/LW and transferring them by the setting of "Setting1" and "Setting2" of "Station inherent parameter"

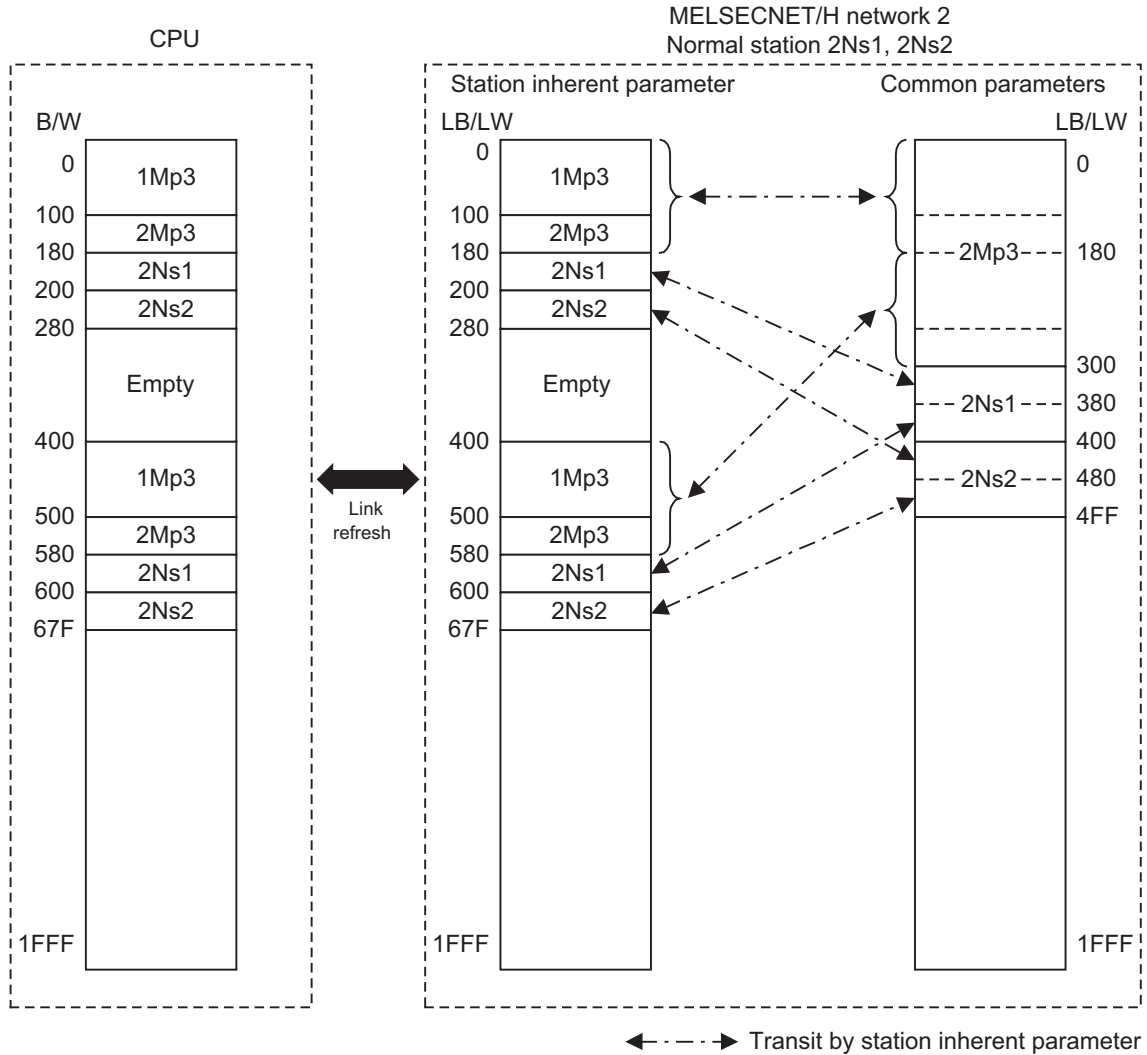

The following describes the network parameter setting of MELSECNET/H network 1 normal stations 2Ns1, 2Ns2 (Q02UCPU).

1) Network parameter setting (Q02UCPU: MELSECNET/H network 2 normal stations 2Ns1, 2Ns2)

	Module 1	Module 2	Module 3	Module 4
Network Type	MNET/H Mode(Normal Station)	None	None	None
Start I/O No.	0000			
Network No.	2			
Total Stations				
Group No.	0			
Station No.				
Mode	Online			
	Station Inherent Parameters			
	Refresh Parameters			
	Interrupt Settings			

2) Station inherent parameter (Q02UCPU: MELSECNET/H network 2 normal stations 2Ns1, 2Ns2)

Reference Network Range Assignment

Workspace Location: C:\MELSEC\Gppw\

Workspace Name:

Project Name: Q06UDVCPU\_j Board No. 2

Assignment Method:  Points/Start  Start/End

Parameter Name:

Switch Screens: LB Setting

Reference Read Cancel

Station No.	Setting 1			Setting 2			Network Range Assignment			Pairing
	Points	Start	End	Points	Start	End	Points	Start	End	
1	128	0180	01FF	128	0580	05FF	256	0300	03FF	Disable
2	128	0200	027F	128	0600	067F	256	0400	04FF	Disable
3	384	0000	017F	384	0400	057F	768	0000	02FF	Disable

Reference Network Range Assignment

Workspace Location: C:\MELSEC\Gppw\

Workspace Name:

Project Name: Q06UDVCPU\_j Board No. 2

Assignment Method:  Points/Start  Start/End

Parameter Name:

Switch Screens: LW Setting

Reference Read Cancel

Station No.	Setting 1			Setting 2			Network Range Assignment			Pairing
	Points	Start	End	Points	Start	End	Points	Start	End	
1	128	0180	01FF	128	0580	05FF	256	0300	03FF	Disable
2	128	0200	027F	128	0600	067F	256	0400	04FF	Disable
3	384	0000	017F	384	0400	057F	768	0000	02FF	Disable



### 3) Refresh parameter (Q02UCPU: MELSECNET/H network 2 normal stations 2Ns1, 2Ns2)

Assignment Method  
 Points/Start  
 Start/End

Transient Transmission Error History Status  
 Overwrite    Hold

	Link Side					PLC Side			
	Dev. Name	Points	Start	End		Dev. Name	Points	Start	End
Transfer SB	SB	512	0000	01FF	↔	SB	512	0000	01FF
Transfer SW	SW	512	0000	01FF	↔	SW	512	0000	01FF
Random Cyclic	LB				↔				
Random Cyclic	LW				↔				
Transfer 1	LB	1664	0000	067F	↔	B	1664	0000	067F
Transfer 2	LW	1664	0000	067F	↔	W	1664	000000	00067F
Transfer 3					↔				
Transfer 4					↔				
Transfer 5					↔				
Transfer 6					↔				

\* MELSECNET diagnostics may not be displayed correctly although END processing time of CPU is shortened when the points of SB transfer/SW transfer are reduced.

## 2.6 Program Comparisons

### 2.6.1 Comparison of special relays M (SB) and special registers D (SW)

#### (1) Master station special relays

Special relays enabled when host station is the master station.

○ : Compatible, △ : Partial change required, × : Incompatible

Special relay in the case of MELSECNET (II) master station			Corresponding MELSECNET/H special relay				
Number	Name	Description	Number	Name	Description	Compat-ibility	Precautions for replacement
M9200	LRDP instruction received	OFF : Not accepted ON : Accepted	None	-	-	△	Delete when used in a sequence program. (Refer to Section 2.6.2 Transient instructions.)
M9201	LRDP instruction complete	OFF : Not completed ON : Completed	None	-	-	△	Delete when used in a sequence program. (Refer to Section 2.6.2 Transient instructions.)
M9202	LWTP instruction received	OFF : Not accepted ON : Accepted	None	-	-	△	Delete when used in a sequence program. (Refer to Section 2.6.2 Transient instructions.)
M9203	LWTP instruction complete	OFF : Not completed ON : Completed	None	-	-	△	Delete when used in a sequence program. (Refer to Section 2.6.2 Transient instructions.)
M9206	Link parameter error in the host	OFF : Normal ON : Abnormal	SB0055	Receive parameter error	OFF : Parameter normal ON : Parameter abnormal	○	
M9207	Link parameter check results	OFF : Match ON : Mismatch	None	-	-	△	Delete when used in a sequence program as a 3-tier system cannot be configured.
M9208	Master station B,W transmission range setting (only master station of lower link)	OFF : Transmits to tier2 and tier3 ON : Transmits to tier2 only	None	-	-	△	Delete when used in a sequence program as a 3-tier system cannot be configured.
M9209	Check instructions of link parameters (only master station of lower link)	OFF : Executing the check function ON : Check non-execution	None	-	-	△	Delete when used in a sequence program as a 3-tier system cannot be configured.
M9210	Link card error (for master station)	OFF : Normal ON : Abnormal	SB0020	Module status	OFF : Normal ON : Abnormal	○	
M9224	Link status	OFF : Online ON : Offline, station-to-station test, or self-loopback test	SB0043	Online switch	OFF : Online ON : Other than online	○	
M9225	Forward loop error	OFF : Normal ON : Abnormal	SB0090	Host loop status	OFF : Normal ON : Abnormal	○	When ON, confirm the loop status by SW0090. The loop status can also be judged by the host station bits of SW0091 to SW0094.
			SB0092 (when host station is remote master station)	Forward loop status of the remote master station	OFF : Normal ON : Abnormal	○	

(to next page)

○ : Compatible, △ : Partial change required, × : Incompatible

Special relay in the case of MELSECNET (II) master station			Corresponding MELSECNET/H special relay				
Number	Name	Description	Number	Name	Description	Compat-ibility	Precautions for replacement
M9226	Reverse loop error	OFF : Normal ON : Abnormal	SB0090	Host loop status	OFF : Normal ON : Abnormal	○	When ON, confirm the loop status by SW0090. The loop status can also be judged by the host station bits of SW0095 to SW0098.
			SB0096 (when host station is remote master station)	Reverse loop status of the remote master station	OFF : Normal ON : Abnormal	○	
M9227	Loop test status	OFF : Not being executed ON : Forward loop test/reverse loop test execution underway	SB00AC	Offline test instruction status	OFF : Not instructed ON : Instructed	○	
M9232	Local station operation status	OFF : RUN or STEP RUN status ON : STOP or PAUSE status	SB0084	Each station CPU RUN status	OFF : All stations RUN or STEP RUN status ON : Stations in the STOP or PAUSE status exist	○	
M9233	Local station error detection status	OFF : No error ON : Error detection	None	-	-	△	Can be substituted by SB0074.
M9235	Local station, remote I/O station parameter error detection status	OFF : No error ON : Error detection	SB007C	Parameter status of each station	OFF : No station detected parameter errors ON : A station detected parameter errors	○	
M9236	Local station, remote I/O station initial communications status	OFF : No communication ON : Communication in progress	SB0078	Parameter status of each station	OFF : Parameter communication not in progress ON : Parameter communication in progress	○	
M9237	Local station, remote I/O station error	OFF : Normal ON : Abnormal	SB0074	Cyclic transmission status of each station	OFF : All stations normal ON : Station where cyclic transmission is not executing exist	○	
M9238	Local station, remote I/O station forward/reverse loop error	OFF : Normal ON : Abnormal	SB0091	Forward loop status	OFF : All stations normal ON : Faulty station present	○	
			SB0095	Reverse loop status	OFF : All stations normal ON : Faulty station present	○	

## (2) Local station special relay

Special relays enabled when host station is the local station.

○ : Compatible, △ : Partial change required, × : Incompatible

Special relay in the case of MELSECNET (II) local station			MELSECNET/H special relay				
Number	Name	Description	Number	Name	Description	Compatibility	Precautions for replacement
M9204	LRDP instruction complete	OFF : Not completed ON : Completed	None	-	-	△	Delete when used in a sequence program. (Refer to Section 2.6.2 Transient instructions.)
M9205	LWTP instruction complete	OFF : Not completed ON : Completed	None	-	-	△	Delete when used in a sequence program. (Refer to Section 2.6.2 Transient instructions.)
M9211	Link card error (for local station)	OFF : Normal ON : Abnormal	SB0020	Module status	OFF : Normal ON : Abnormal	○	
M9240	Link status	OFF : Online ON : Offline, station-to-station test, or self-loopback test	SB0043	Online switch	OFF : Online ON : Other than online	○	
M9241	Forward loop error	OFF : Normal ON : Abnormal	SB0090	Host loop status	OFF : Normal ON : Abnormal	○	When ON, confirm the loop status by SW0090. The loop status can also be judged by the host station bits of SW0091 to SW0094.
M9242	Reverse loop error	OFF : Normal ON : Abnormal	SB0090	Host loop status	OFF : Normal ON : Abnormal	○	When ON, confirm the loop status by SW0090. The loop status can also be judged by the host station bits of SW0095 to SW0098.
M9243	Loopback execution	OFF : Loopback not executed ON : Loopback execution	SB0090	Host loop status	OFF : Normal ON : Abnormal	○	When ON, confirm the loop status by SW0090. The loop status can also be judged by whether SW0099 and SW009A are the host station No.
M9246	Data not received from master station	OFF : Received ON : Not received	None	-	-	△	Delete when used in a sequence program as a 3-tier system cannot be configured.
M9247	Data not received from the upper loop in 3-tier system	OFF : Received ON : Not received	None	-	-	△	Delete when used in a sequence program as a 3-tier system cannot be configured.
M9250	Parameter unreceived	OFF : Received ON : Not received	SB0054	Parameter receive status	OFF : Receive completed ON : Not received	○	
M9251	Link break	OFF : Normal ON : Cancel	SB0049	Host station data link status	OFF : Normal ON : Abnormal	○	
M9252	Loop test status	OFF : Not being executed ON : Forward loop test/reverse loop test execution underway	SB00AE	Offline testing response designation	OFF : No response ON : Response	○	

(to next page)

○ : Compatible, △ : Partial change required, × : Incompatible

Special relay in the case of MELSECNET (II) local station			MELSECNET/H special relay				
Number	Name	Description	Number	Name	Description	Compat- ibility	Precautions for replacement
M9253	Master station operation status	OFF : RUN or STEP RUN status ON : STOP or PAUSE status	SW0084 to SW0087	Each station CPU RUN status	Stores the CPU RUN status of each station.	○	When the MELSECNET II master station is the MELSECNET/H specified control station, the operation status is distinguished by the corresponding bit of the control station specified on SW0084 to SW0087.
M9254	Operating status of other local stations	OFF : RUN or STEP RUN status ON : STOP or PAUSE status	SB0084	Each station CPU RUN status	OFF : All stations RUN or STEP RUN status ON : Stations in the STOP or PAUSE status exist	○	
M9255	Local station error on stations other than host station	OFF : Normal ON : Abnormal	SB0074	Cyclic transmission status of each station	OFF : All stations normal ON : Station where cyclic transmission is not executing exist	○	

## (3) Master station special register

Special register enabled when host station is the master station.

○ : Compatible, △ : Partial change required, × : Incompatible

Special register in the case of MELSECNET (II) master station			MELSECNET/H special register				
Number	Name	Description	Number	Name	Description	Compat- ibility	Precautions for replacement
D9200	LRDP processing results	0: Normal completion 2: LRDP instruction setting fault 3: Error at relevant station 4: Relevant station LRDP execution disabled	None	-	-	△	Delete when used in a sequence program. (Refer to Section 2.6.2 Transient instructions.)
D9201	LWTP processing results	0: Normal completion 2: LWTP instruction setting fault 3: Error at relevant station 4: Relevant station LRDP execution disabled	None	-	-	△	Delete when used in a sequence program. (Refer to Section 2.6.2 Transient instructions.)
D9202	Local station link type	Stores whether or not the normal station is a MELSECNET compatible station or a MELSECNET II compatible station.	None	-	-	△	Delete when used in a sequence program due to MELSECNET/H system.
D9203							
D9241							
D9242							
D9204	Link status	0: Forward loop, during data link 1: Reverse loop, during data link 2: Loopback implemented in forward/reverse directions 3: Loopback implemented in only forward direction 4: Loopback implemented only in reverse direction 5: Data link disabled	SW0049 (SW0090 to SW009A)	Cause of data link transmission stop	0: Normal 1: Stop instruction issued 2: No common parameters 3: Common parameter error 4: Host station CPU error 6: Communication canceled	△	Check whether or not the data link is normally SW0049. (Loop status is judged comprehensively by SW0090 to SW009A.)
D9205	Station implementing loopback	Station that implemented forward loopback	SW0099	Loopback station (forward loop side)	Stores the number of stations executing the loopback on the forward loop side.	○	
D9206	Station implementing loopback	Station that implemented reverse loopback	SW009A	Loopback station (reverse loop side)	Stores the number of stations executing the loopback on the reverse loop side.	○	
D9207	Link scan time	Max. value	SW006B	Link scan time	Max. value	○	
D9208		Min. value	SW006C		Min. value	○	
D9209		Current value	SW006D		Current value	○	
D9210	Retry	Stored as cumulative value	SW00C8	Number of retries on the forward loop side	Accumulates and stores the number of retries on the forward loop side.	△	The retries on the forward loop side are stored as a cumulative value.
			SW00C9	Number of retries on the reverse loop side	Accumulates and stores the number of retries on the reverse loop side.	△	The retries on the reverse loop side are stored as a cumulative value.

(to next page)

○ : Compatible, △ : Partial change required, × : Incompatible

Special register in the case of MELSECNET (II) master station			MELSECNET/H special register				
Number	Name	Description	Number	Name	Description	Compatibility	Precautions for replacement
D9211	Loop switching count	Stored as cumulative value	SW00CE	Loop switching count	Accumulates and stores the number of loop checks conducted.	○	
D9212	Local station operation status	Stores local stations in a STOP or PAUSE status.	SW0084	Each station CPU RUN status	Stores the CPU RUN status of each station.	○	
D9213			SW0085				
D9214			SW0086				
D9215			SW0087				
D9216	Local station error detection status	Stores whether each local station has detected any error in other station.	None	-	-	△	Can be substituted by SW0074 to SW0077.
D9217							
D9218							
D9219							
D9220	Local station parameter mismatch	Turns ON when a local station or a remote I/O station has detected an error on the link parameters from the master station.	SW007C	Parameter error status of each station	Stores the parameter status of each station.	○	
D9221			SW007D				
D9222			SW007E				
D9223	Remote I/O station I/O assignment error		SW007F				
D9224	Local station, remote I/O station initial communication underway	Stores stations that are performing communication of link parameters.	SW0078	Parameter communication status of each station	Stores the communication status of each station parameters.	○	
D9225			SW0079				
D9226			SW007A				
D9227			SW007B				
D9228	Local station, remote I/O station error	Stores data link error stations.	SW0074	Cyclic transmission status of each station	Stores the cyclic transmission status of each station.	○	
D9229			SW0075				
D9230			SW0076				
D9231			SW0077				
D9232	Local station and remote I/O station loop error	Stores the station that detected the error on the forward loop line and reverse loop line.	SW0091	Forward loop status of each station	Stores the forward loop status of each station.	△	The error on the loop line of the forward loop is stored.
D9233			SW0092				
D9234			SW0093				
D9235			SW0094	Reverse loop status of each station	Stores the reverse loop status of each station.	△	The error on the loop line of the reverse loop is stored.
D9236			SW0095				
D9237			SW0096				
D9238			SW0097				
D9239			SW0098				
D9240	Number of receive error detection times	Stores cumulative total of receive errors	SW00B8 to SW00C7	Various error counters	Various error counters	△	The error count for each error cause is stored.

**(4) Local station special register**

Special registers enabled when host station is a local station

○ : Compatible, △ : Partial change required, × : Incompatible

Special register in the case of MELSECNET (II) master station			MELSECNET/H special register				
Number	Name	Description	Number	Name	Description	Compat- ibility	Precautions for replacement
D9243	Station number information for host station	Stores the station number. (0 to 64)	SW0042	Station No.	Stores the station number of the host.	○	
D9244	Number of link device stations	Stores number of normal stations.	SW0056	Total number of link stations	Stores the total number of link stations that is set with the parameters.	○	
D9245	Number of receive error detection times	Stores cumulative total of receive errors.	SW00B8 to SW00C7	Various error counters	Various error counters	△	The error count for each error cause is stored.
D9248	Local station operation status	Stores local stations in a STOP or PAUSE status.	SW0084	Each station CPU RUN status	Stores the CPU RUN status of each station.	○	
D9249			SW0085				
D9250			SW0086				
D9251			SW0087				
D9252	Local station error status	Stores the local station number other than the host, which is in error.	SW0074	Cyclic transmission status of each station	Stores the cyclic transmission status of each station.	○	
D9253			SW0075				
D9254			SW0076				
D9255			SW0077				



2.6.2 Transient instructions

(1) MELSECNET II dedicated instruction

Dedicated instructions that were used on MELSECNET II need to be replaced with the following dedicated instructions on MELSECNET/H.

The table below shows a comparison between dedicated instructions on MELSECNET II and dedicated instructions on MELSECNET/H. The table also shows reference items in the Q Corresponding MELSECNET/H Network System Reference Manual (PLC to PLC Network). Check these reference items before changing the sequence program.

MELSECNET II			MELSECNET/H			Reference item in the manual
Instruction name	Category	Description	Instruction name	Category	Description	
LRDP	Reading from local station	The master station reads the word devices (T, C, D, W) on local stations.	READ	Other station word device read	Reads device data on other stations of target network No.	Section 7.4.5
			SREAD		Reads device data on other stations of target network No. by A-compatible instructions.	Section 7.4.5
LWTP	Writing to local station	The master station writes to the word devices (T, C, D, W) on local stations.	WRITE	Other station word device write	Writes data to devices on other stations of target network No.	Section 7.4.5
			SWRITE		Writes data to devices on other stations of target network No. by A-compatible instructions.	Section 7.4.5

The following describes operation by the instructions.

○ : Can be used, ×: Cannot be used

Instruction	Name	Execution station	Description	Target station		
		QCPU		QCPU	QnA/QnA-SCPU	AnU/AnUS(H) CPU
READ SREAD	Other station word device read	○	<p>Reads CPU device data on target stations of target network No. (in 16-bit units)</p>	○	○	×
WRITE SWRITE	Other station word device write	○	<p>Writes data to CPU device on target station of target network No. (in 16-bit units) (Devices on the target station can be turned ON by SWRITE.)</p>	○	○	×

(to next page)

○ : Can be used, × : Cannot be used

Instruction	Name	Execution station	Description	Target station		
		QCPU		QCPU	QnA/ QnA- SCPU	AnU/ AnUS(H) CPU
ZNRD	Other station word device read	○	<p>[A-compatible instruction] Reads CPU device data on target stations of target network No.</p>	○	○	○*1 AnACPU AnNCPU
ZNWR	Other station word device write	○	<p>[A-compatible instruction] Writes data to CPU device on target station of target network No.</p>	○	○	○*1 AnACPU AnNCPU

\*1 CPU modules of the following version or later when the target station is the A2UCPU(S1), A3UCPU, A4UCPU, or A2USCPU(S1)

- A2UCPU(S1), A3UCPU, A4UCPU: Version AY (manufactured in July 1995) or later
- A2USCPU(S1): Version CP (manufactured in July 1995) or later

## 2.7 Replacement Precautions

The following shows the replacement precautions when replacing MELSECNET (II) with MELSECNET/H.

### (1) Cables

For details on precautions for optical cables and coaxial cables, refer to Section 2.2.2 Cable performance comparisons.

### (2) System configuration

#### (a) System configuration using local stations and remote I/O stations in MELSECNET mode and MELSECNET II mode

MELSECNET/H system, which is a composite system comprising local stations and remote stations, provides high-performance functions by making a separation between local stations and remote stations. It therefore cannot be configured by a mixture of local stations and remote stations. For this reason, in a MELSECNET (II) system, when replacing a system, which comprises a mixture of local stations and remote I/O stations connected to a single master station, with a MELSEC/H system, the following system configuration is necessary. Normal stations are connected to a single control station, and remote I/O stations are controlled by an additional remote master station (the control station in a remote I/O system is defined as the "remote master station"). The following shows a system configuration example.

For a parameter change example, refer to Section 3.5.2.

System configuration using local and remote stations (optical)

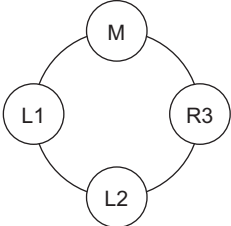
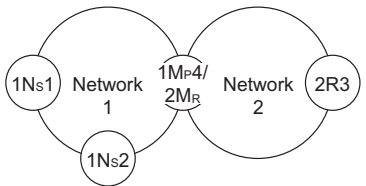
MELSECNET ( II ) ( optical )	MELSECNET/H ( optical )	Remarks ( proposed measure )
Optical loop 	Optical loop 	<ul style="list-style-type: none"> <li>The control station of network No.1 configures a PLC to PLC network that controls normal station 1 and normal station 2.</li> <li>The other network module becomes the remote master station, and the remote I/O network system of No.2 is configured.</li> </ul>

#### (b) MELSECNET (II) system comprising 65 connected modules

The maximum number of stations on the MELSECNET/H system is 64 (one control station, 63 normal stations).

The maximum number of stations on the MELSECNET (II) system is 65 (one master station, 64 local stations + remote I/O stations). For this reason, when the maximum number of 65 MELSECNET/H modules are connected, measures (e.g. division into two networks of 64 modules or less having a different network No.) are required.

**(3) Sequence program****(a) Data separation prevention**

When two words (32 bits) or more of cyclic data are handled, the old data sometimes is mixed with the new data. To read/write cyclic data of two words or more in a single operation, set data separation prevention by the following method.

**1) Interlock program using BW**

Data separation can be prevented by performing handshaking using BW between the cyclic data sending station and cyclic data receiving station.

The following shows an example of an interlock program for handshaking.

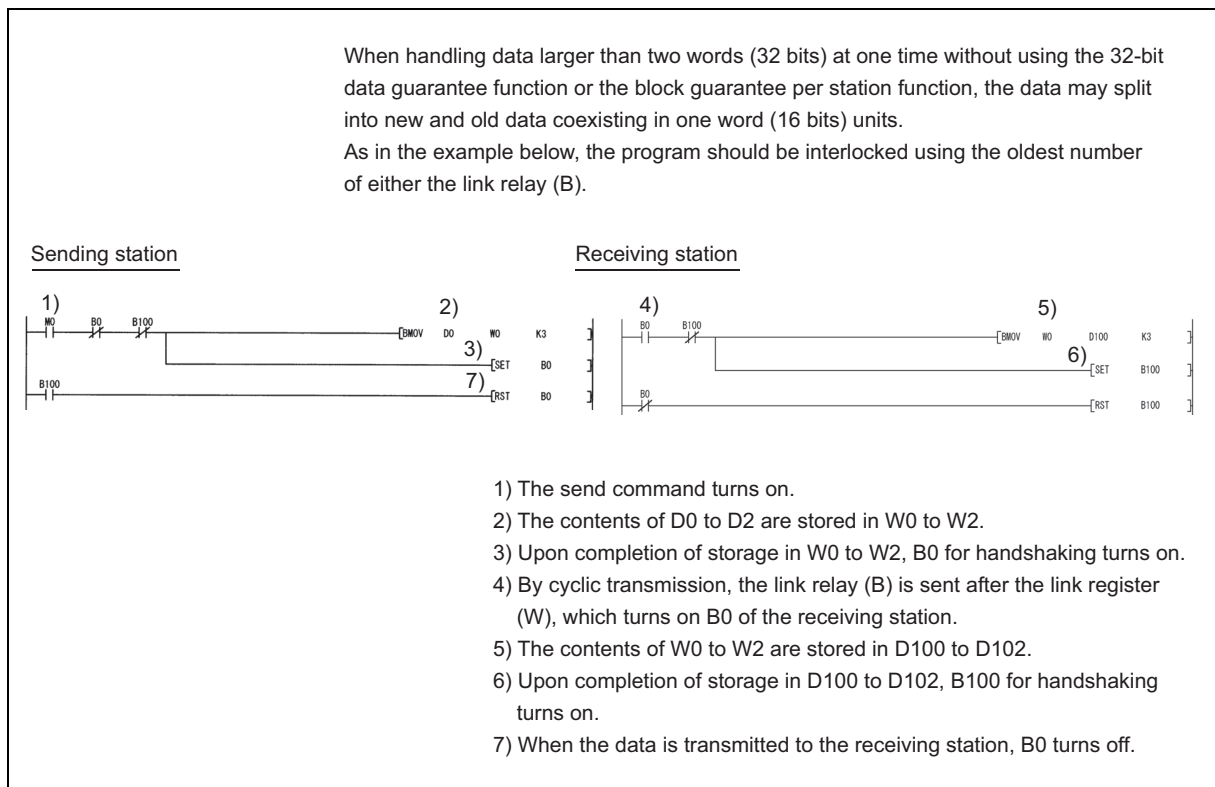

## 2) Per-station block guarantee function

When the "interlock program using BW" in 1) cannot be made, use the per-station block guarantee function for MELSECNET/H cyclic data. By enabling the per-station block guarantee function, handshaking is performed between CPU modules and network modules to refresh the network, and enables data separation prevention of cyclic data per station. The per-station block guarantee function is enabled when "Secured data send" and "Secured data receive" in the following parameters are set.

MELSECNET/10H Supplementary Setting

Constant Scan  ms

Maximum No. of Returns to System Stations in 1 Scan  Station

With multiplex transmission

There is a data link through the sub-controlling station when the controlling station is down.

Block send data assurance per station

Block receive data assurance per station

Transient Setting

Maximum No. of Transients in 1 Scan  Times

Maximum No. of Transients in One Station  Times

Specification of Low Speed Cyclic Transmission

Transmit Data of One Station in 1 Scan.

Fixed Interval Cycle Setting  Second

System Timer Setting

	Year	Month	Day	Hour	Minute	Second
1						
2						
3						
4						
5						
6						
7						
8						

End Cancel

### (b) BW first half/second half assignments in the MELSECNET II mode and composite mode

Set the station inherent parameters of the MELSECNET/H to all stations to re-use MELSECNET II sequence programs more efficiently.

### (c) Processing time

The link scan time and link refresh time differ between the A/AnS/QnA/QnAS series and the Q series. For details on processing times, refer to the manual for the respective module.

**(4) Precautions for system where AnN/AnS/AnACPU are mixed.**

Pay attention to the following when replacing the MELSECNET II system where AnN/AnA/AnSCPU (excluding AnUS(H)CPU) are mixed, with the MELSECNET/10 system.

Refer to "Chapter 11 COMPOSITE SYSTEMS" in "Type MELSECNET/10 Network system (PLC to PLC network) Reference Manual", for details.

**(a) Control station of the MELSECNET/10 system**

MELSECNET/10 system after transition requires one AnU/AnUS(H)/QnA/QnAS/QCPU as a control station.

In addition, because AnN/AnA/AnSCPU (excluding AnUS(H)CPU) cannot be a sub-control station in the transition to MELSECNET/10, the MELSECNET/10 system after transition requires two or more AnU/AnUS(H)/QnA/QnAS/QCPU to use the control station shift function of MELSECNET/10.

**(b) Device range where data link can be executed on the MELSECNET/10 system**

Device range where data link can be executed on the MELSECNET/10 system is the device range of AnN/AnS/AnACPU to be connected.

	X/Y	B/Y
AnN/AnSCPU (excluding AnUS(H)CPU)	Maximum 0000 to 07FF* <sup>1</sup>	0000 to 03FF
AnACPU	Maximum 0000 to 07FF* <sup>2</sup>	0000 to 0FFF

\*<sup>1</sup> For A3NCPUs. Depends on the number of I/O points that can be controlled by AnN/AnSCPU (excluding AnUS(H)CPU).

\*<sup>2</sup> For A3ACPU. Depends on the number of I/O points that can be controlled by AnACPU.

**(c) When AnN/AnA/AnSCPU (excluding AnUS(H)CPU) are mixed in transition from MELSECNET II composite mode to MELSECNET/10**

Communicable B/W range is 0 to 3FF when AnN/AnSCPU (excluding AnUS(H)CPU) are mixed on MELSECNET/10.

When the second half is set on the MELSECNET II composite mode, it is necessary to divide with station inherent parameter for transferring data, but the station inherent parameter cannot be set on AnN/AnSCPU (excluding AnUS(H)CPU).

AnACPU can communicate at the range of B/W0 to FFF, but station inherent parameter cannot be set.

From here onwards, it may cause a communication error of the area divided by station inherent parameter at the other station where transmission of B/W 400 or later cannot be made.

When replacing MELSECNET II composite mode with MELSECNET/10 where AnN/AnA/AnSCPU (excluding AnUS(H)CPU) are mixed, replace AnN/AnA/AnSCPU (excluding AnUS(H)CPU) with a CPU that is applicable to MELSECNET/10, such as QCPU.

# 3 REPLACEMENT OF MELSECNET (II) AND /B (REMOTE I/O NETWORK)

## 3.1 List of MELSECNET (II) and /B Alternative Models

### (1) Replacement of MELSECNET (II) modules with MELSECNET/H modules

Network type	A/AnS/A0J2(H) series	Alternative models for Q series
Optical loop (CPU integrated type)	A1NCPUP21	CPU module + QJ71LP21-25 (Optical loop: SI cable supported)
	A2NCPUP21	
	A2NCPUP21-S1	
	A3NCPUP21	
	A2ACPUP21	
	A2ACPUP21-S1	
	A3ACPUP21	
	A2CCPUP21	
	A0J2HCPUP21	
Optical loop (CPU integrated type)	A1NCPUP21-S3	CPU module + QJ71LP21G (Optical loop: GI cable supported)
	A2NCPUP21-S3	
	A2NCPUP21-S4	
	A3NCPUP21-S3	
	A2ACPUP21-S3	
	A2ACPUP21-S4	
Coaxial loop (CPU integrated type)	A1NCPUR21	CPU module + QJ71BR11 (Coaxial bus)
	A2NCPUR21	
	A2NCPUR21-S1	
	A3NCPUR21	
	A2ACPUR21	
	A2ACPUR21-S1	
	A3ACPUR21	
	A2CCPUR21	
	A0J2HCPUR21	
Optical loop (Standalone)	AJ71AP21	QJ71LP21-25 (Optical loop: SI cable supported)
	A1SJ71AP21	
Optical loop (Standalone)	AJ71P21-S3	QJ71LP21G (Optical loop: GI cable supported)
	AJ71AP21-S3	
	AJ71P22-S3	
	AJ71AP22-S3	
	A1SJ71AP21-S3	
Coaxial loop (Standalone)	AJ71AR21	QJ71BR11 (Coaxial bus)
	A1SJ71AR21	
Optical loop (Standalone) (Remote I/O station)	AJ72P25	QJ72LP25-25 (Optical loop: SI cable supported)
	AJ72P25-S1	
Optical loop (Standalone) (Remote I/O station)	AJ72P25-S3	QJ72LP25G (Optical loop: GI cable supported)
	A0J2P25	
Coaxial loop (Standalone) (Remote I/O station)	AJ72R25	QJ72BR15 (Coaxial bus)
	AJ72R25-S1	
	A0J2R25	

## (2) Replacement of MELSECNET/B modules with MELSECNET/H modules

Network type	A/AnS series	Alternative models for Q series
Twisted pair	AJ71AT21B	QJ71LP21-25 (Optical loop)
	A1SJ71AT21B	QJ71BR11 (Coaxial bus)
Twisted pair	AJ72T25B	QJ72LP25-25 (Optical loop)
	A1SJ72T25B	QJ72BR15 (Coaxial bus)



## 3.2 Specifications Comparisons

### 3.2.1 Module specifications comparisons

#### (1) Comparison between MELSECNET (II) module (optical loop) and MELSECNET/H module (optical loop)

##### (a) SI optical cable, H-PCF optical cable

○ : Compatible, △ : Partial change required, × : Incompatible

Item		Specifications		Compat- ibility	Precautions for replacement
		MELSECNET (II) module	MELSECNET/H module		
		Optical loop	Optical loop (QJ71LP21-25, QJ72LP25-25)		
Maximum number of link points per network	X/Y	Max. 2048 points and max. number of I/O points of CPU module on master station	8192 points	○	
	B	-	16384 points (Remote master station → remote I/O station: 8192 points, remote I/O station → remote master station: 8192 points)	○	
	W	• (MELSECNET mode) 1024 points • (MELSECNET II composite mode) 4096 points	16384 points (Remote master station → remote I/O station: 8192 points, remote I/O station → remote master station: 8192 points)	○	
Maximum number of link points per station	Master station	• (MELSECNET mode) 1024 bytes • (MELSECNET II composite mode) First half: 1024 bytes	Remote master station → remote I/O station $\{(LY + LB) \div 8 + (2 \times LW)\} \leq 1600$ bytes	○	
	Remote I/O station	512 bytes	Remote I/O station → remote master station $\{(LX + LB) \div 8 + (2 \times LW)\} \leq 1600$ bytes		
Maximum number of I/O points per station		512 points	4096 points	○	
Communication speed		1.25 Mbps	25Mbps/10Mbps	○	
Number of stations connected in one network		65 stations (Master station: 1, local station + remote I/O station: 64)	65 stations (Remote master station: 1, remote I/O station: 64)	△	Set the PLC to PLC network to a separate network.
Applicable cable		SI optical cable H-PCF optical cable	SI optical cable H-PCF optical cable Broad-band H-PCF optical cable QSI optical cable	△	When using existing SI cables, the distance between stations may be shortened. (Refer to Section 3.2.2.)
Overall distance		10km	30km	○	
Distance between stations		Refer to Section 3.2.2.	Refer to Section 3.2.2.	△	To ensure the same distance as before replacement, either change the optical cable, or install a gateway station midway along existing cables.
Maximum number of networks		-	239	△	New MELSECNET/H parameter (mandatory)
Communication method		Half duplex bit serial method	Token ring method	△	Nothing to be noted though the communication method differs.
Transmission method		Duplex loop		○	
Modulation method (Encoding method)		(Modulation method) CMI method	(Encoding method) NRZI coding	△	Nothing to be noted though the modulation method differs.
Transmission format		HDLC standards (frame format)		○	
Error control system		CRC ( $X^{16}+X^{12}+X^6+1$ ) and retry by a time over		○	
RAS function		• Loop-back function due to error detection or broken cable • Diagnostic function for checking local link lines		○	
Number of occupied I/O points		(Master station) CPU integrated type: 0 point Standalone: 32 points per slot (I/O assignment: special 32 points)	(Master station) 32 points per slot (I/O assignment: intelli. 32 points)	△	When the master station is replaced from a CPU integrated type, one new slot (32 points) is required.

## (b) Modules for GI optical cable

○ : Compatible, △ : Partial change required, × : Incompatible

Item		Specifications		Compat- ibility	Precautions for replacement
		MELSECNET (II) module	MELSECNET/H module		
		Optical loop	Optical loop(QJ71LP21G, QJ72LP25G)		
Maximum number of link points per network	X/Y	Max. 2048 points and max. number of I/O points of CPU module on master station	8192 points	○	
	B	-	16384 points (Remote master station → remote I/O station: 8192 points, remote I/O station → remote master station: 8192 points)	○	
	W	• (MELSECNET mode) 1024 points • (MELSECNET II composite mode) 4096 points	16384 points (Remote master station → remote I/O station: 8192 points, remote I/O station → remote master station: 8192 points)	○	
Maximum number of link points per station	Master station	• (MELSECNET mode) 1024 bytes • (MELSECNET II composite mode) link parameter First half: 1024 bytes link parameter Second half: 1024 bytes	Remote master station → remote I/O station $\{(LY + LB) \div 8 + (2 \times LW)\} \leq 1600$ bytes	○	
	Remote I/O station	512 bytes	Remote I/O station → remote master station $\{(LX + LB) \div 8 + (2 \times LW)\} \leq 1600$ bytes		
Maximum number of I/O points per station		512 points	4096 points	○	
Communication speed		1.25 Mbps	10 Mbps	○	
Number of stations connected in one network		65 stations (Master station: 1, local station + remote I/O station: 64)	65 stations (Remote master station: 1, remote I/O station: 64)	△	Set the PLC to PLC network to a separate network.
Applicable cable		GI optical cable	GI optical cable	○	
Overall distance		10 km	30 km	○	
Distance between stations		GI optical cable: 2km	GI optical cable: 2km	○	
Maximum number of networks		-	239	△	New MELSECNET/H parameter (mandatory)
Communication method		Half duplex bit serial method	Token ring method	△	Nothing to be noted though the communication method differs.
Transmission method		Duplex loop		○	
Modulation method (Encoding method)		(Modulation method) CMI method	(Encoding method) NRZI coding	△	Nothing to be noted though the modulation method differs.
Transmission format		HDLC standards (frame format)		○	
Error control system		CRC ( $X^{16}+X^{12}+X^5+1$ ) and retry by a time over		○	
RAS function		• Loop-back function due to error detection or broken cable • Diagnostic function for checking local link lines		○	
Number of occupied I/O points		(Master station) CPU integrated type: 0 point Standalone: 32 points per slot (I/O assignment: special 32 points)	(Master station) 32 points per slot (I/O assignment: intelli. 32 points)	△	When the master station is replaced from a CPU integrated type, one new slot (32 points) is required.

## (2) Comparison between MELSECNET (II) module (coaxial loop) and MELSECNET/H module (coaxial bus)

○ : Compatible, △ : Partial change required, × : Incompatible

Item		Specifications		Compat- ibility	Precautions for replacement
		MELSECNET (II) module	MELSECNET/H module		
		Coaxial loop	Coaxial bus (QJ71BR11, QJ72BR15)		
Maximum number of link points per network	X/Y	Max. 2048 points and max. number of I/O points of CPU module on master station	8192 points	○	
	B	-	16384 points (Remote master station → remote I/O station: 8192 points, remote I/O station → remote master station: 8192 points)	○	
	W	• (MELSECNET mode) 1024 points • (MELSECNET II composite mode) 4096 points	16384 points (Remote master station → remote I/O station: 8192 points, remote I/O station → remote master station: 8192 points)	○	
Maximum number of link points per station	Master station	• (MELSECNET mode) 1024 bytes • (MELSECNET II composite mode) link parameter first half: 1024 bytes	Remote master station → remote I/O station $\{(LY + LB) \div 8 + (2 \times LW)\} \leq 1600$ bytes	○	
	Remote I/O station	512 bytes	Remote I/O station → remote master station $\{(LX + LB) \div 8 + (2 \times LW)\} \leq 1600$ bytes		
Maximum number of I/O points per station		512 points	4096 points	○	
Communication speed		1.25 Mbps	10 Mbps	○	
Number of stations connected in one network		65 stations (Master station: 1, local station + remote I/O station: 64)	33 stations (Remote master station: 1, remote I/O station: 32)	△	<ul style="list-style-type: none"> <li>Set the PLC to PLC network to a separate network.</li> <li>For stations over 33, build a separate network.</li> </ul>
Applicable cable		3C-2V 5C-2V		△	When using existing cables, the overall distance and distance between stations becomes shorter.
Overall distance		3C-2V: 10km 5C-2V: 10km	3C-2V: 300m 5C-2V: 500m	△	Either use an A6BR10/A6BR10-DC type repeater unit, or configure a separate network.
Distance between stations		3C-2V: 500m 5C-2V: 500m	3C-2V: 300m 5C-2V: 500m	△	When using the 3C-2V, use the A6BR10/A6BR10-DC type repeater unit.
Maximum number of networks		-	239	△	New MELSECNET/H parameter (mandatory)
Communication method		Half duplex bit serial method	Token ring method	△	Nothing to be noted though the communication method differs.
Transmission method		Duplex loop	Single bus	△	Nothing to be noted though the transmission method differs.
Modulation method (Encoding method)		(Modulation method) CMI method	(Encoding method) Manchester code	△	Nothing to be noted though the modulation method differs.
Transmission format		HDLC standards (frame format)		○	
Error control system		CRC ( $X^{16}+X^{12}+X^5+1$ ) and retry by a time over		○	
RAS function		<ul style="list-style-type: none"> <li>Loop-back function due to error detection or broken cable</li> <li>Diagnostic function for checking local link lines</li> </ul>	Diagnostic function for checking local link lines	△	The loopback function cannot be used on a coaxial bus system. To use the loopback function, using an optical loop system is recommended.
Number of occupied I/O points		(Master station) CPU integrated type: 0 point Standalone: 32 points per slot (I/O assignment: special 32 points)	(Master station) 32 points per slot (I/O assignment: intelli. 32 points)	△	When the master station is replaced from a CPU integrated type, one new slot (32 points) is required.

## (3) Comparison between MELSECNET/B module (twisted pair) and MELSECNET/H module (optical loop/coaxial bus)

○ : Compatible, △ : Partial change required, × : Incompatible

Item		Specifications			Compat- ibility	Precautions for replacement	
		MELSECNET/B module		MELSECNET/H module			
		Twisted pair		Optical loop (QJ71LP21-25)			Coaxial bus (QJ71BR11)
Maximum number of link points per network	X/Y	Max. 2048 points and max. number of I/O points of CPU module on master station		8192 points		○	
	B	-		16384 points (Remote master station → remote I/O station: 8192 points, remote I/O station → remote master station: 8192 points)		○	
	W	<ul style="list-style-type: none"> <li>• (MELSECNET mode) 1024 points</li> <li>• (MELSECNET II composite mode) 4096 points</li> </ul>		16384 points (Remote master station → remote I/O station: 8192 points, remote I/O station → remote master station: 8192 points)		○	
Maximum number of link points per station	Master station	<ul style="list-style-type: none"> <li>• (MELSECNET mode) 1024 bytes</li> <li>• (MELSECNET II composite mode) Link parameter first half: 1024 bytes</li> </ul>		Remote master station → remote I/O station $\{(LY + LB) \div 8 + (2 \times LW)\} \leq 1600$ bytes		○	
	Remote I/O station	512 bytes		Remote I/O station → remote master station $\{(LX + LB) \div 8 + (2 \times LW)\} \leq 1600$ bytes			
Maximum number of I/O points per station		512 points		4096 points		○	
Communication speed		125kbps/250kbps/500kbps/1Mbps		25Mbps/10Mbps	-	○	
				-	10Mbps	○	
Number of stations connected in one network		32 stations (Master station: 1, local station + remote I/O station: 31)		65 stations (Remote master station: 1, remote I/O station: 64)	-	△	Set the PLC to PLC network to a separate network.
				-	33 stations (Remote master station: 1, remote I/O station: 32)	△	Set the PLC to PLC network to a separate network.
Applicable cable		Shielded twisted pair cable		SI optical cable H-PCF optical cable Broad-band H-PCF optical cable QSI optical cable	-	△	A new optical cable has to be installed.
				-	3C-2V 5C-2V	△	A new coaxial cable has to be installed.
Overall distance		125kbps: 1200m 250kbps: 600m 500kbps: 400m 1Mbps: 200m		30km	-	○	Either use an A6BR10/ A6BR10-DC type repeater unit, or configure a separate network.
				-	3C-2V: 300m 5C-2V: 500m	△	
Distance between stations		125kbps: 1200m 250kbps: 600m 500kbps: 400m 1Mbps: 200m		Refer to Section 3.2.2.	-	○	When 1200m is required, use GI optical cables for all optical cables, and use QJ71LP21G as the module.
				-	3C-2V: 300m 5C-2V: 500m	△	Either use an A6BR10/ A6BR10-DC type repeater unit, or configure a separate network.
Maximum number of networks		-		239		△	New MELSECNET/H parameter (mandatory)

(to next page)

○ : Compatible, △ : Partial change required, × : Incompatible

Item	Specifications			Compat- ibility	Precautions for replacement
	MELSECNET/B module	MELSECNET/H module			
	Twisted pair	Optical loop (QJ71LP21-25)	Coaxial bus (QJ71BR11)		
Communication method	Half duplex bit serial method	Token ring method		△	Nothing to be noted though the communication method differs.
Transmission method	Single bus	Duplex loop	-	○	
		-	Single bus	○	
Modulation method (Encoding method)	(Modulation method) NRZI method	(Encoding method) NRZI coding	-	○	
		-	(Encoding method) Manchester code	△	Nothing to be noted though the modulation method differs.
Transmission format	HDLC standards (frame format)			○	
Error control system	CRC ( $X^{16}+X^{12}+X^5+1$ ) and retry by a time over			○	
RAS function	Diagnostic function for checking local link lines			○	
Number of occupied I/O points	(Master station) Standalone: 32 points per slot (I/O assignment: special 32 points)	(Master station) 32 points per slot (I/O assignment: intelli. 32 points)		○	

## 3.2.2 Cable performance comparisons

### (1) Optical fiber cable

#### (a) Overall distance

The overall distance (30km) does not differ according to the optical fiber cable.

#### (b) Distance between stations

##### 1) SI optical fiber cable

○ : Compatible, △ : Partial change required, × : Incompatible

Type		MELSECNET (II) module (Optical loop)	MELSECNET/H module (Optical loop)		Compat-ibility	Precautions for replacement
			10Mbps	25Mbps		
SI optical fiber cable (type: A-2P-□)	L type	1km	500m	200m	△	Refer to *1 below.
	H type	500m	300m	100m	△	
SI optical fiber cable (type: AN-2P-□)		1km	500m	200m	△	Refer to *2 below.
H-PCF optical fiber cable		1km	1km	400m	△	
Broad-band H-PCF optical fiber cable		-	1km	1km	○	
QSI optical fiber cable		-	1km	1km	○	

\*1 When the distance between stations does not satisfy the MELSECNET/H specifications, either change the type of optical fiber cable, or install a gateway station midway along existing cables.

\*2 When the distance between stations does not satisfy the MELSECNET/H specifications, use at a communication speed of 10 Mbps, change the type of optical fiber cable, or install a gateway station midway along existing cables.

##### 2) GI optical fiber cable

○ : Compatible, △ : Partial change required, × : Incompatible

Type	MELSECNET (II) module (Optical loop)	MELSECNET/H module (Optical loop)	Compat-ibility	Precautions for replacement
GI optical fiber cable	2km	2km	○	

### (2) Coaxial cable

#### (a) Overall distance

○ : Compatible, △ : Partial change required, × : Incompatible

Type	MELSECNET (II) module (Coaxial loop)	MELSECNET/H module (Coaxial bus)	Compat- ibility	Precautions for replacement
3C-2V	10km	300m	△	Refer to*3 below.
5C-2V	10km	500m	△	

\*3 When the overall distance does not satisfy the MELSECNET/H specifications, either use an A6BR10/A6BR10-DC type repeater unit in the network, or configure a separate network.

#### (b) Distance between stations

○ : Compatible, △ : Partial change required, × : Incompatible

Type	MELSECNET (II) module (Coaxial loop)	MELSECNET/H module (Coaxial bus)	Compat- ibility	Precautions for replacement
3C-2V	500m	300m	△	Refer to*4 below.
5C-2V	500m	500m	○	

\*4 When the distance between stations does not satisfy the MELSECNET/H specifications, either use an A6BR10/A6BR10-DC type repeater unit in the network.

#### Remarks

The following shows the extension method when a repeater unit for the A6BR10/A6BR10-DC type MELSECNET/10 coaxial bus system is used. For details, refer to the Repeater Unit for the MELSECNET/10 Coaxial Bus System type A6BR10/A6BR10-DC User's Manual (IB-66499).

(1) The distance between stations of 500m (5C-2V) and 300m (3C-2V) can be extended.

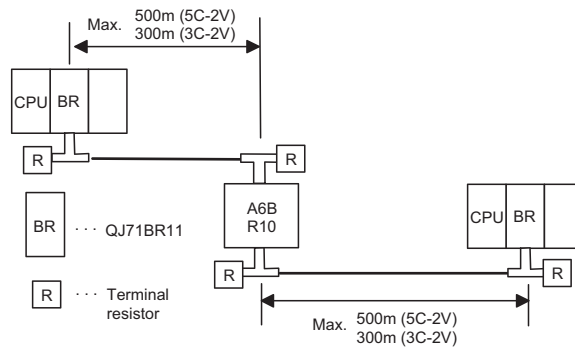

(2) Up to four repeater units can be used in a single network.\*5

The overall distance can be extended to a maximum distance of 2.5 km.

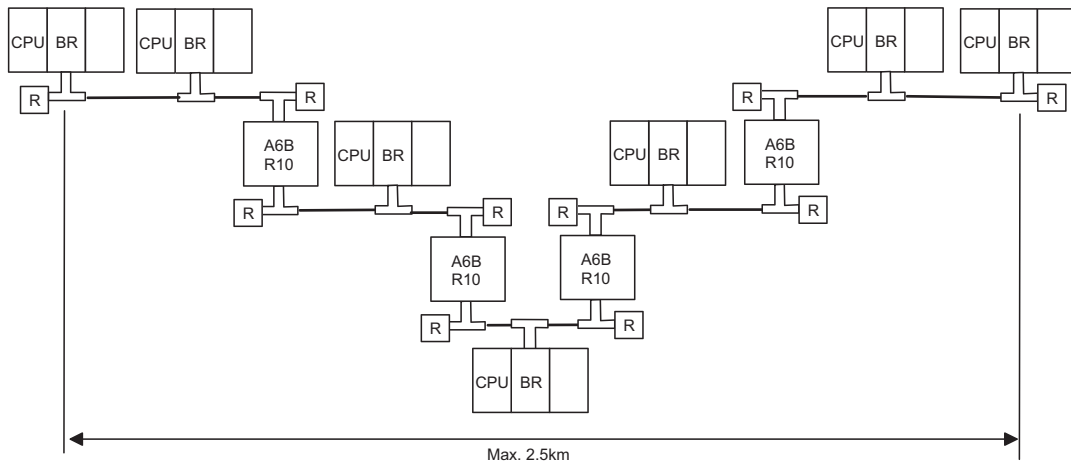

\*5 It is necessary to add terminal resistor A6RCON-R75 (sold separately).

## 3.3 Functional Comparisons

○ : Compatible, △ : Partial change required, × : Incompatible

Item	Description		Compat- ibility	Precautions for replacement
	MELSECNET (II) module MELSECNET/B module	MELSECNET/H module		
Cyclic transmission	X/Y are used to perform 1:1 communications between the master station and local stations, and the master station and remote I/O stations.	X/Y are used to perform 1:1 communications between the remote master station and remote I/O stations.	○	
Transient transmission	<ul style="list-style-type: none"> <li>The RFRP/RTOP instructions issued from the master station are used to read/write the buffer memory of special function modules at remote I/O stations.</li> <li>Other stations are accessed from GX Developer connected to the master station.</li> <li>The master station is accessed from GX Developer connected to remote I/O stations.</li> </ul>	<ul style="list-style-type: none"> <li>The REMFR/REMO instructions issued from the remote master station are used to read/write the buffer memory of intelligent function modules at remote I/O stations.</li> <li>Other stations are accessed from GX Works2 or GX Developer connected to the remote master station.</li> <li>The remote master station is accessed from GX Works2 or GX Developer connected to remote I/O stations.</li> </ul>	△	Correct the RFRP/RTOP instructions for reading/writing buffer memory on intelligent function modules at remote I/O stations to the REMFR/REMO instructions. (Refer to Section 3.6.2.)
Automatic return function	When a disconnected remote I/O station returns to normal status, it is automatically restored and the data link is resumed.		○	
Loopback function	In the case of an optical loop system and coaxial loop system, faulty parts are disconnected when a fault (e.g. cable disconnection) occurs, and normal operation is continued on operable stations as a result of the loopback.	In the case of an optical loop system, faulty parts are disconnected when a fault (e.g. cable disconnection) occurs, and normal operation is continued on operable stations as a result of the loopback.	○	
Error detection	Faulty parts are detected by the data of special relays (M9200 to 9255) and special registers (D9200 to 9255).	Faulty parts are detected by the data of link special relays (SB0 to 1FF) and link special registers (SW0 to 1FF).	△	Change the devices in the sequence program. (Refer to Section 3.6.1.)
Self-diagnosis test function	Set the following test items by the mode setting switch: <ul style="list-style-type: none"> <li>Self-loopback test</li> <li>Station-to-station test</li> <li>Forward loop/reverse loop test</li> </ul>	Set the following test items by the mode setting switch: <ul style="list-style-type: none"> <li>Self-loopback test</li> <li>Internal self-loopback test</li> <li>Hardware test</li> </ul> Set the following test items in the network parameters: <ul style="list-style-type: none"> <li>Forward loop/reverse loop test</li> </ul>	△	<ul style="list-style-type: none"> <li>Set the forward loop/reverse loop test in the network parameter settings.</li> <li>Substitute the station-to-station test with the forward loop/reverse loop test.</li> </ul>



### 3.4 Switch Settings Comparisons

#### (1) Comparison between MELSECNET (II) modules and MELSECNET/H modules

○ : Compatible, △ : Partial change required, × : Incompatible

Switch name	Description		Compat- ibility	Precautions for replacement
	MELSECNET (II) module	MELSECNET/H module		
Station number setting switch	Sets the station number.	Sets the station number.	○	
Mode select switch	Sets the mode for operation self-diagnostics test.	Sets the mode for operation self-diagnostics test.	△	The forward loop/reverse loop test is set in GX Works2 or GX Developer network parameter settings.

#### (2) Comparison between MELSECNET/B modules and MELSECNET/H modules

○ : Compatible, △ : Partial change required, × : Incompatible

Switch name	Description		Compat- ibility	Precautions for replacement
	MELSECNET (II) module	MELSECNET/H module		
Station number setting switch	Sets the station number.	Sets the station number.	○	
Mode select switch	Sets the mode for operation self-diagnostics test.	Sets the mode for operation self-diagnostics test.	△	The forward loop/reverse loop test is set in GX Works2 or GX Developer network parameter settings.
Communication speed setting switch	Sets the communication speed.	-	△	The setting is not required.

### 3.5 Parameter Comparisons

#### 3.5.1 Parameter comparisons

The network parameters of MELSECNET (II) are deleted when the programmable controller type is changed with the GX Developer. After changing the programmable controller type, set the MELSECNET/H network parameters again.

##### (1) MELSECNET (II) → MELSECNET/H

The following shows a comparison between MELSECNET (II) network parameter settings and MELSECNET/H network parameter settings.

The MELSECNET (II) master station is compared with the MELSECNET/H master station.

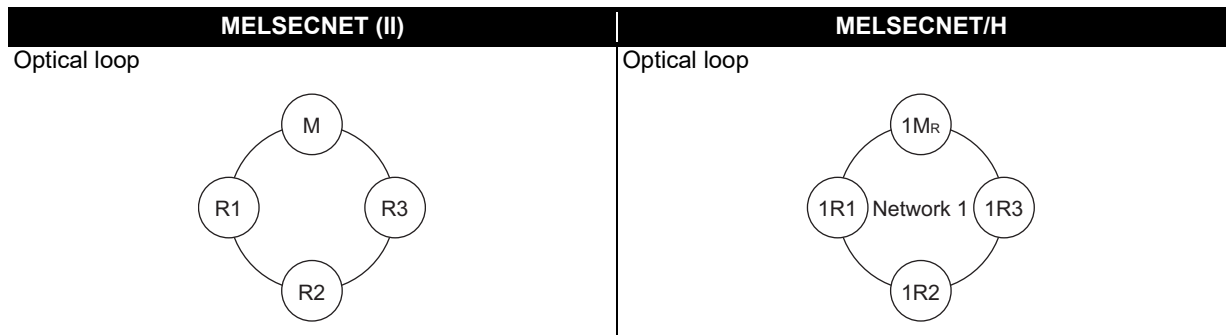

○ : Compatible, △ : Partial change required, × : Incompatible

MELSECNET (II)		MELSECNET/H		Compat- ibility	Precautions for replacement		
Master station	Network type	Master station	Network type	○			
	Starting I/O No.* <sup>1</sup>		Starting I/O No.	○			
	- (No setting)		Network No.	△	Mandatory for the MELSECNET/H.		
	Total number of (normal) stations		Total number of (normal) stations	○			
	Network range assignments		LB, LW assignments on the master station and remote I/O stations	Network range assignments	LB, LW assignments on the master station and remote I/O stations	○	
					Station inherent parameter	△	* <sup>2</sup>
Network range assignments	LX/LY assignments on the master station and remote I/O stations	Network range assignments	Supplemental settings- Secured data send	△	* <sup>3</sup>		
			Supplemental settings- Secured data receive				
Network range assignments	LX/LY assignments on the master station and remote I/O stations	Network range assignments	LX/LY assignments on the master station and remote I/O stations	○			
			Refresh parameters* <sup>1</sup>	Refresh parameters	○		
Remote I/O station	- (No setting)	Remote I/O station	- (No setting)				

\*<sup>1</sup> This is set when the AnU/AnUS(H)/QnA/QnASCPU is mounted.

\*<sup>2</sup> Applied when LB/LW are set for both the first half/second half on MELSECNET (II). (For details, refer to Section 3.5.2 Parameter change example.)

\*<sup>3</sup> This is the data separation prevention function for reading/writing cyclic data of two words or more in a single operation. (For details, refer to Section 3.7 Replacement Precautions.)

### 3.5.2 Parameter change example

The following shows an example of how to change the LB/LW, LX/LY network parameters when replacing the MELSECNET remote system with MELSECNET/H.

The MELSECNET remote system can be used in the following operation modes.

- MELSECNET mode
- MELSECNET II composite mode

#### (1) MELSECNET mode

The following shows the procedure for changing the parameters in the case of a MELSECNET mode 2-tier system configuration.

A MELSECNET composite system comprising local stations and remote I/O stations is divided into a PLC to PLC network and a remote I/O network in the MELSECNET/H.

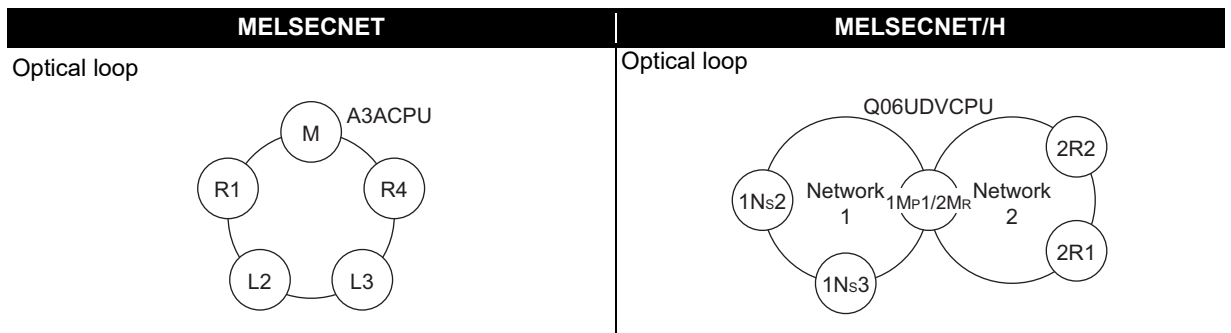

MELSECNET mode 2-tier system configuration example

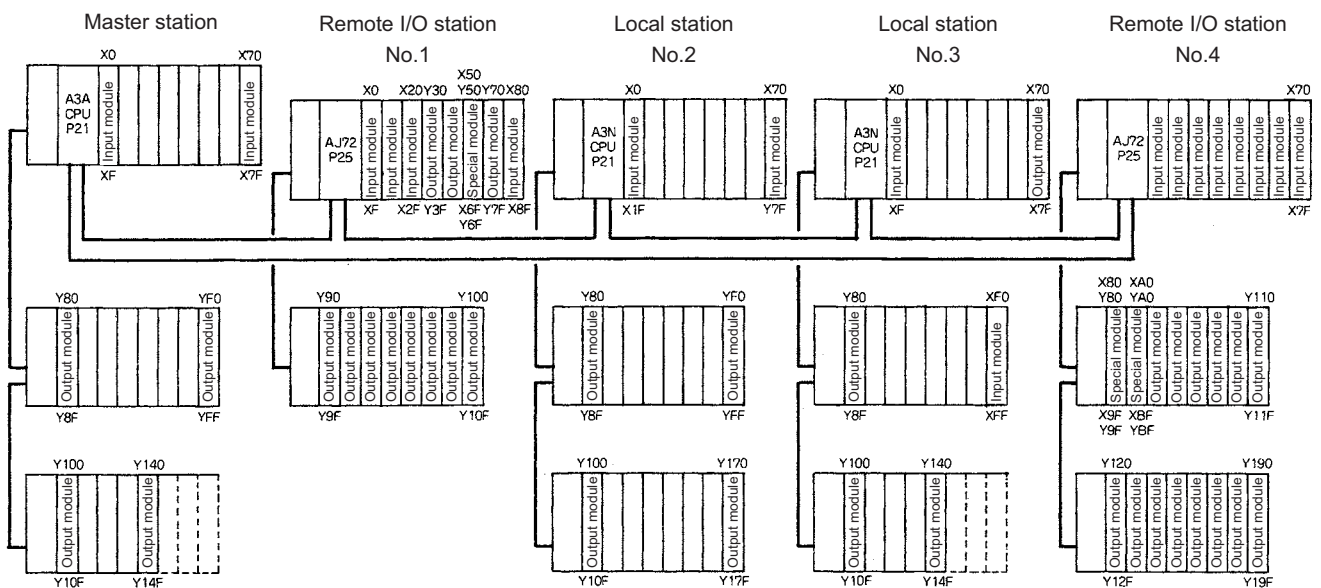

### (a) Setting ranges of MELSECNET link parameters

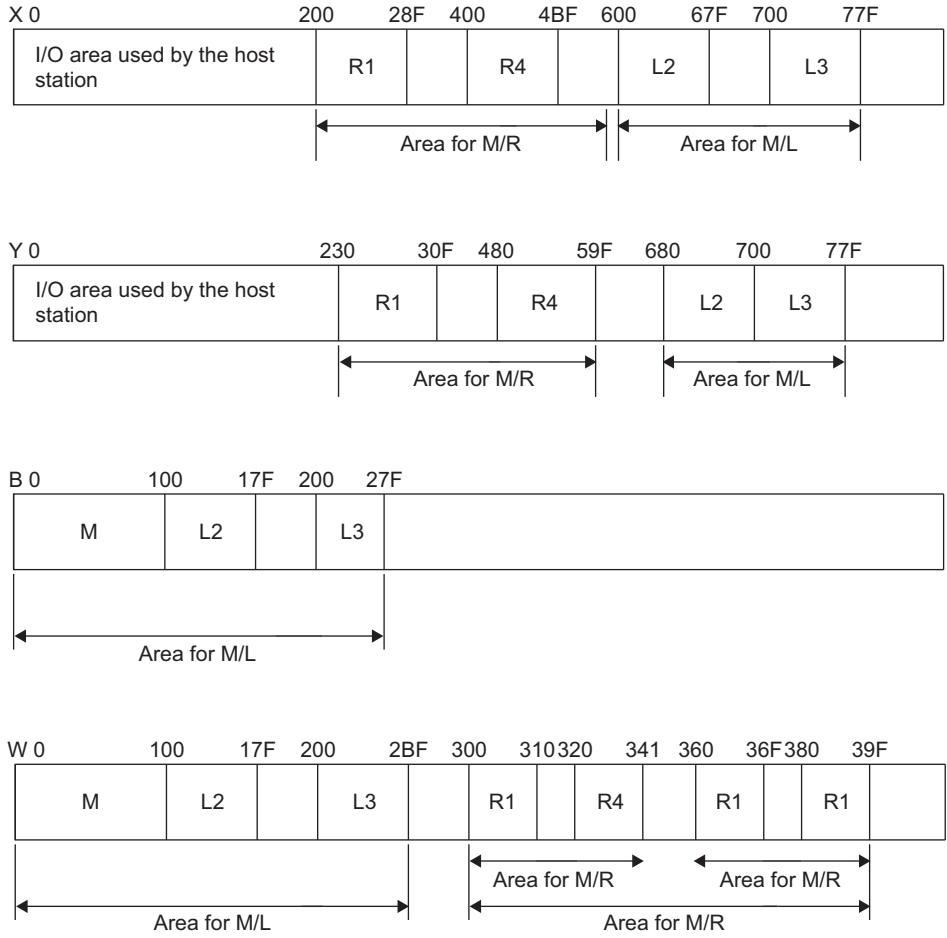

### (b) Setting ranges of MELSECNET/H link parameters

#### 1) Setting ranges of network 1 link parameters

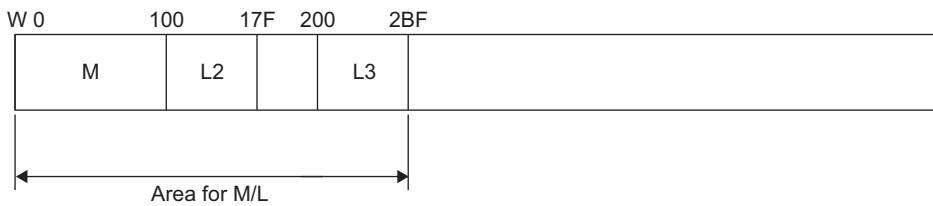
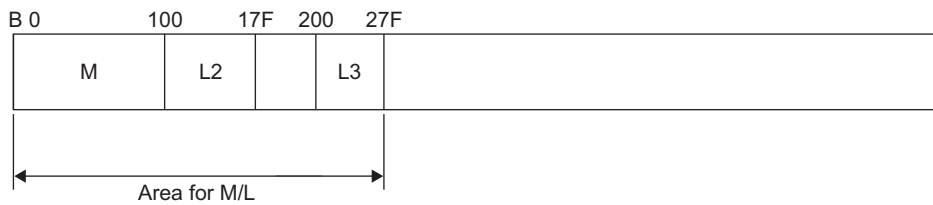
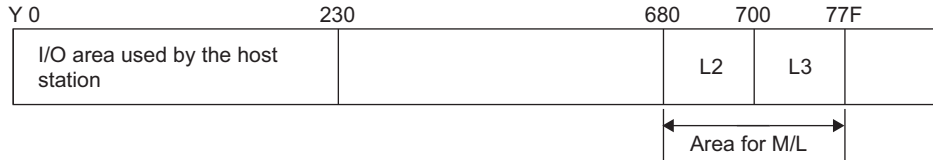
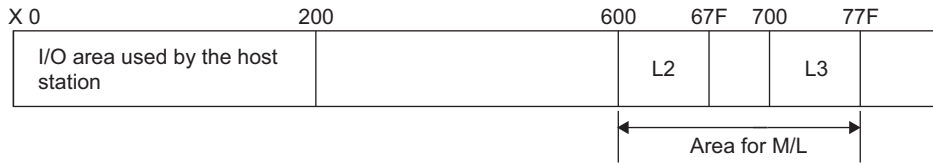

#### 2) Setting ranges of network 2 link parameters

The REMFR, REMTO instructions do not use B, W, and the setting of B, W is not required. Only X, Y are set.

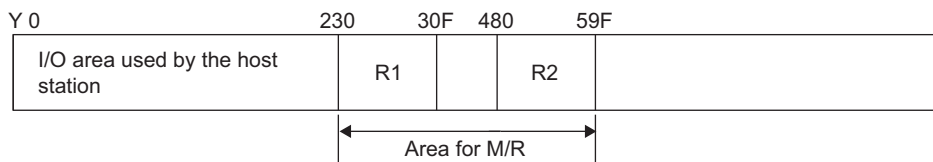
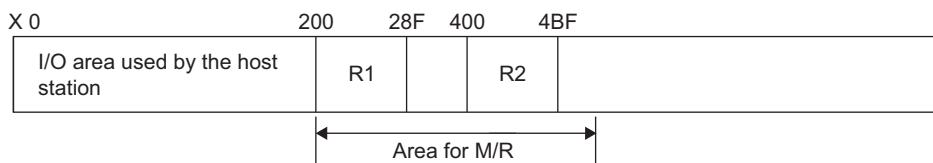

A MELSECNET/H module set as normal station requires network parameter setting. For replacement of MELSECNET (II) module mounted on the CPU module of the AnN/AnA/AnSCPU (excluding AnUS(H)CPU), newly set network parameters.

The following shows parameters required on each station of MELSECNET/H.

	Common parameter (Network range assignment)	Refresh parameter
1Mp1	○ (Refer to example in (e) 2) and 3))	○ (Refer to example in (e) 4))
2MR	○ (Refer to example in (f) 1) and 2))	○ (Refer to example in (f) 3))
1Ns2		○ (Refer to example in (g) 2))
1Ns3		○ (Refer to example in (g) 2))
2R2		
2R3		

○ : Setting required/ △ : Setting required (Default setting is also acceptable)

### (c) MELSECNET master station

The following shows the network parameter settings of the MELSECNET master station (A3ACPU).

#### 1) Network parameter setting (A3ACPU: MELSECNET master station)

	Module No.1	Module No.2	Module No.3	Module No.4
Network type	MNET(Master station)	None	None	None
Start I/O No.				
Network No.				
Total stations	4			
Group No.				
Station No.				
Network range assignment				
Necessary setting[ No setting / Already set ] Set if it is needed[ No setting / Already set ]				
Interlink transmission parameters		Start I/O No.: <input type="text" value="1"/> Valid module during other station access		<input type="button" value="Check"/>
Input the start I/O No. installed in the module in 16-point unit.				
<input type="button" value="Acknowledge XY assignment"/> <input type="button" value="Routing parameters"/> <input type="button" value="Check"/> <input type="button" value="End"/> <input type="button" value="Cancel"/>				

#### 2) Network range assignment (A3ACPU: MELSECNET master station)

Setup common parameters

Assignment method  
 Points/Start  
 Start/End

Monitoring time  × 10ms

Total slave stations

Switch screens

L/R station No.	M station -> L/R station						M station <- L/R station					
	LY			LX/LY			LX			LY/LX		
	Points	Start	End	Points	Start	End	Points	Start	End	Points	Start	End
M 0												
R 1	224	0230	030F	224	0030	010F	144	0200	028F	144	0000	008F
L 2	128	0680	06FF	128	0200	027F	128	0600	067F	128	0280	02FF
L 3	128	0700	077F	128	0200	027F	128	0700	077F	128	0200	027F
R 4	288	0480	059F	288	0080	019F	192	0400	048F	192	0000	00BF

#### 3) Network range assignment (A3ACPU: MELSECNET master station)

Setup common parameters

Assignment method  
 Points/Start  
 Start/End

Monitoring time  × 10ms

Total slave stations

Switch screens

L/R station No.	Send range for each station			Send range for each station			M station -> R station			M station <- R station		
	LB			LW			LW			LW		
	Points	Start	End	Points	Start	End	Points	Start	End	Points	Start	End
M 0	256	0000	00FF	256	0000	00FF						
R 1							17	0300	0310	16	0360	036F
L 2	128	0100	017F	128	0100	017F						
L 3	128	0200	027F	192	0200	02BF						
R 4							34	0320	0341	32	0380	039F

**(d) MELSECNET local station, remote I/O station**

As all stations perform cyclic communication according to the network range assignments of the master station (A3ACPU), the network range assignment parameters of local stations and remote I/O stations need not be set.

**(e) MELSECNET/H control station (network 1)**

The following shows the network parameter settings for when a station is replaced with a MELSECNET/H control station (network 1).

1) Network parameter setting (Q06UDVCPUCPU: MELSECNET/H control station, remote master station)

	Module 1	Module 2	Module 3	Module 4
Network Type	MNET/H Mode(Control Station)	MNET/H(Remote Master)	None	None
Start I/O No.	0000	0020		
Network No.	1	2		
Total Stations	3	2		
Group No.	0			
Station No.				
Mode	Online	Online		
	Network Range Assignment	Network Range Assignment		
	Refresh Parameters	Refresh Parameters		
	Interrupt Settings	Interrupt Settings		
	Return as Control Station			
	Optical/Coaxial			

2) Network range assignment (Q06UDVCPUCPU: MELSECNET/H control station)

Set up common and station inherent parameters.

Assignment Method  
 Points/Start  
 Start/End

Monitoring Time: 200 X 10ms  
 Parameter Name:   
 Total Slave Stations: 3  
 Switch Screens: LX/LY Setting(1)

Station No.	M St. -> L St.						M St. <- L St.						Pairing
	LY			LX			LX			LY			
	Points	Start	End	Points	Start	End	Points	Start	End	Points	Start	End	
Master 1 1													
2	128	0680	06FF	128	0200	027F	128	0600	067F	128	0280	02FF	
3	128	0700	077F	128	0200	027F	128	0700	077F	128	0200	027F	

3) Network range assignment (Q06UDVCPUCPU: MELSECNET/H control station)

Set up common and station inherent parameters.

Assignment Method  
 Points/Start  
 Start/End

Monitoring Time: 200 X 10ms  
 Parameter Name:   
 Total Slave Stations: 3  
 Switch Screens: LB/LW Setting

Station No.	Send Range for each Station LB			Send Range for each Station LW			Send Range for each Station Low Speed LB			Send Range for each Station Low Speed LW			Pairing
	Points	Start	End	Points	Start	End	Points	Start	End	Points	Start	End	
Master 1 1	256	0000	00FF	256	0000	00FF							Disable
2	128	0100	017F	128	0100	017F							Disable
3	128	0200	027F	144	0200	028F							Disable



### 4) Refresh parameters (Q06UDVCPU: MELSECNET/H control station)

Assignment Method  
 Points/Start  
 Start/End

Transient Transmission Error History Status  
 Overwrite    Hold

	Link Side					PLC Side			
	Dev. Name	Points	Start	End		Dev. Name	Points	Start	End
Transfer SB	SB	512	0000	01FF	↔	SB	512	0000	01FF
Transfer SW	SW	512	0000	01FF	↔	SW	512	0000	01FF
Random Cyclic	LB				↔	▼			
Random Cyclic	LW				↔	▼			
Transfer 1	LB ▼	768	0000	02FF	↔	B ▼	768	0000	02FF
Transfer 2	LW ▼	768	0000	02FF	↔	W ▼	768	000000	0002FF
Transfer 3	LX ▼	128	0600	067F	↔	X ▼	128	0600	067F
Transfer 4	LX ▼	128	0700	077F	↔	X ▼	128	0700	077F
Transfer 5	LY ▼	128	0680	06FF	↔	Y ▼	128	0680	06FF
Transfer 6	LY ▼	128	0700	077F	↔	Y ▼	128	0700	077F

\* MELSECNET diagnostics may not be displayed correctly although END processing time of CPU is shortened when the points of SB transfer/SW transfer are reduced.

(f) MELSECNET/H remote master station (network 2)

The following shows the network parameter settings for when a station is replaced with a MELSECNET/H remote master station (network 2).

1) Network range assignment (Q06UDVCPU: MELSECNET/H remote master station)

Setup common parameters and I/O assignments.

Assignment Method:  Points/Start  Start/End

Monitoring Time: 200 X 10ms

Parameter Name:

Total Slave Stations: 2

Switch Screens: XY Setting

Station No.	M St. -> R St.						M St. <- R St.					
	Y			Y			X			X		
	Points	Start	End	Points	Start	End	Points	Start	End	Points	Start	End
1	224	0230	030F	224	0030	010F	144	0200	028F	144	0000	008F
2	288	0480	059F	288	0080	019F	144	0400	048F	144	0000	008F

2) Network range assignment (Q06UDVCPU: MELSECNET/H remote master station)

Setup common parameters and I/O assignments.

Assignment Method:  Points/Start  Start/End

Monitoring Time: 200 X 10ms

Parameter Name:

Total Slave Stations: 2

Switch Screens: SW Setting

Station No.	M St. -> R St.			M St. <- R St.			M St. -> R St.			M St. <- R St.		
	B			B			W			W		
	Points	Start	End	Points	Start	End	Points	Start	End	Points	Start	End
1												
2												

3) Refresh parameters (Q06UDVCPU: MELSECNET/H remote master station)

Assignment Method:  Points/Start  Start/End

Transient Transmission Error History Status:  Overwrite  Hold

	Link Side						PLC Side				
	Dev. Name	Points	Start	End	Points		Start	End			
Transfer SB	SB	512	0000	01FF	↔	SB	512	0200	03FF		
Transfer SW	SW	512	0000	01FF	↔	SW	512	0200	03FF		
Random Cyclic	LB				↔						
Random Cyclic	LW				↔						
Transfer 1	LX	144	0200	028F	↔	X	144	0220	02AF		
Transfer 2	LX	144	0400	048F	↔	X	144	0400	048F		
Transfer 3	LY	224	0230	030F	↔	Y	224	0230	030F		
Transfer 4	LY	288	0480	059F	↔	Y	288	0480	059F		
Transfer 5					↔						
Transfer 6					↔						

\* MELSECNET diagnostics may not be displayed correctly although END processing time of CPU is shortened when the points of SB transfer/SW transfer are reduced.

An overall picture of CPU-side device assignments on the Q06UDV CPU to which the PLC to PLC network (control station) and remote I/O network (remote master station) is mounted can be checked at [Assignment image diagram] in the GX Works2 or GX Developer network parameters. After setting the parameters, make sure that assignments are correctly set.

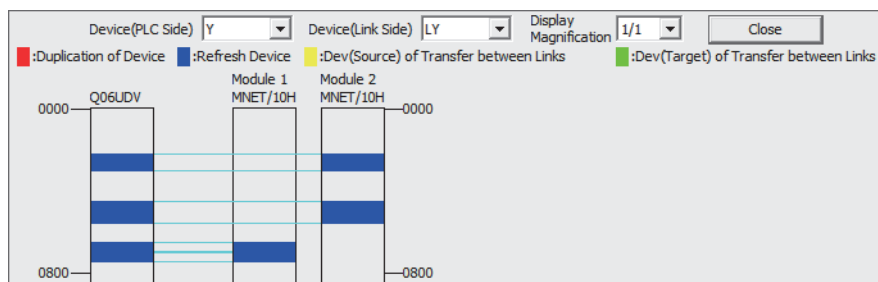
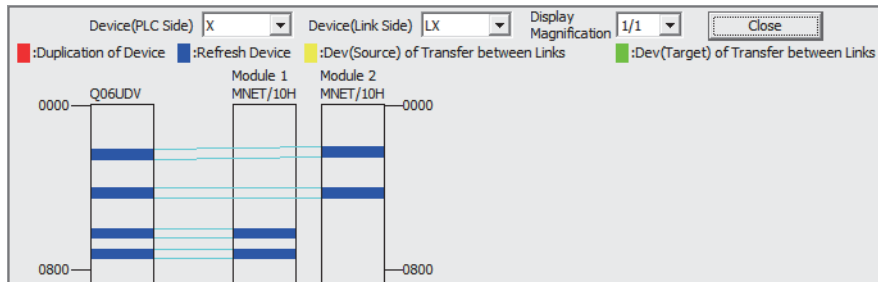

### (g) MELSECNET/H normal station (network 1)

The following shows the network parameter settings for when a station is replaced with a MELSECNET/H control station (network 1).

The same parameter settings are required on all normal stations.

#### 1) Network parameter setting (1 Ns 2: MELSECNET/H normal station)

	Module 1	Module 2	Module 3	Module 4
Network Type	MNET/H Mode(Normal Station)	None	None	None
Start I/O No.	0000			
Network No.	1			
Total Stations				
Group No.	0			
Station No.				
Mode	Online			
	Station Inherent Parameters			
	Refresh Parameters			
	Interrupt Settings			

#### 2) Refresh parameters (1 Ns 2: MELSECNET/H normal station)

Assignment Method

Points/Start

Start/End

Transient Transmission Error History Status

Overwrite  Hold

	Link Side				↔	PLC Side			
	Dev. Name	Points	Start	End		Dev. Name	Points	Start	End
Transfer SB	SB	512	0000	01FF	↔	SB	512	0000	01FF
Transfer SW	SW	512	0000	01FF	↔	SW	512	0000	01FF
Random Cyclic	LB				↔				
Random Cyclic	LW				↔				
Transfer 1	LB	768	0000	02FF	↔	B	768	0000	02FF
Transfer 2	LW	768	0000	02FF	↔	W	768	000000	0002FF
Transfer 3	LX	128	0200	027F	↔	X	128	0200	027F
Transfer 4	LY	128	0280	02FF	↔	Y	128	0280	02FF
Transfer 5					↔				
Transfer 6					↔				

\* MELSECNET diagnostics may not be displayed correctly although END processing time of CPU is shortened when the points of SB transfer/SW transfer are reduced.

## 3.6 Program Comparisons

### 3.6.1 Comparison of special relays M (SB) and special registers D (SW)

#### (1) Master station special relays

Special relays enabled when host station is the master station

○ : Compatible, △ : Partial change required, × : Incompatible

Special relay in the case of MELSECNET (II) master station			Corresponding MELSECNET/H special relay				
Number	Name	Description	Number	Name	Description	Compatibility	Precautions for replacement
M9200	LRDP instruction received	OFF : Not accepted ON : Accepted	None	-	-	△	Delete when used in a sequence program. (Refer to Section 2.6.2 Transient instructions.)
M9201	LRDP instruction complete	OFF : Not completed ON : Completed	None	-	-	△	Delete when used in a sequence program. (Refer to Section 2.6.2 Transient instructions.)
M9202	LWTP instruction received	OFF : Not accepted ON : Accepted	None	-	-	△	Delete when used in a sequence program. (Refer to Section 2.6.2 Transient instructions.)
M9203	LWTP instruction complete	OFF : Not completed ON : Completed	None	-	-	△	Delete when used in a sequence program. (Refer to Section 2.6.2 Transient instructions.)
M9206	Link parameter error in the host	OFF : Normal ON : Abnormal	SB0055	Receive parameter error	OFF: Parameter normal ON: Parameter abnormal	○	
M9207	Link parameter check results	OFF : Match ON : Mismatch	None	-	-	△	Delete when used in a sequence program as a 3-tier system cannot be configured.
M9208	Master station B,W transmission range setting (only master station of lower link)	OFF : Transmits to tier2 and tier3 ON : Transmits to tier2 only	None	-	-	△	Delete when used in a sequence program as a 3-tier system cannot be configured.
M9209	Check instructions of link parameters (only master station of lower link)	OFF : Executing the check function ON : Check non-execution	None	-	-	△	Delete when used in a sequence program as a 3-tier system cannot be configured.
M9210	Link card error (for master station)	OFF : Normal ON : Abnormal	SB0020	Module status	OFF : Normal ON : Abnormal	○	
M9224	Link status	OFF : Online ON : Offline, station-to-station test, or self-loopback test	SB0043	Online switch	OFF : Online ON : Other than online	○	
M9225	Forward loop error	OFF : Normal ON : Abnormal	SB0090	Host loop status	OFF : Normal ON : Abnormal	○	When ON, confirm the loop status by SW0090. The loop status can also be judged by the host station bits of SW0091 to SW0094.
			SB0092 (when host station is remote master station)	Forward loop status of the remote master station	OFF : Normal ON : Abnormal	○	

(to next page)

○ : Compatible, △ : Partial change required, × : Incompatible

Special relay in the case of MELSECNET (II) master station			Corresponding MELSECNET/H special relay				
Number	Name	Description	Number	Name	Description	Compat-ibility	Precautions for replacement
M9226	Reverse loop error	OFF : Normal ON : Abnormal	SB0090	Host loop status	OFF : Normal ON : Abnormal	○	When ON, confirm the loop status by SW0090. The loop status can also be judged by the host station bits of SW0095 to SW0098.
			SB0096 (when host station is remote master station)	Reverse loop status of the remote master station	OFF : Normal ON : Abnormal	○	
M9227	Loop test status	OFF : Not being executed ON : Forward loop test/reverse loop test execution underway	SB00AC	Offline test instruction status	OFF : Not instructed ON : Instructed	○	
M9232	Local station operation status	OFF : RUN or STEP RUN status ON : STOP or PAUSE status	SB0084	Each station CPU RUN status	OFF : All stations RUN or STEP RUN status ON : Stations in the STOP or PAUSE status exist	○	
M9233	Local station error detection status	OFF : No error ON : Error detection	None	-	-	△	Can be substituted by SB0074.
M9235	Local station, remote I/O station parameter error detection status	OFF : No error ON : Error detection	SB007C	Parameter status of each station	OFF : No station detected parameter errors ON : A station detected parameter errors	○	
M9236	Local station, remote I/O station initial communications status	OFF : No communication ON : Communication in progress	SB0078	Parameter status of each station	OFF : Parameter communication not in progress ON : Parameter communication in progress	○	
M9237	Local station, remote I/O station error	OFF : Normal ON : Abnormal	SB0074	Cyclic transmission status of each station	OFF : All stations normal ON : Station where cyclic transmission is not executing exist	○	
M9238	Local station, remote I/O station forward/reverse loop error	OFF : Normal ON : Abnormal	SB0091	Forward loop status	OFF : All stations normal ON : Faulty station present	○	
			SB0095	Reverse loop status	OFF : All stations normal ON : Faulty station present	○	

## (2) Master station special register

Special register enabled when host station is the master station

○ : Compatible, △ : Partial change required, × : Incompatible

Special register in the case of MELSECNET (II) master station			MELSECNET/H special register				
Number	Name	Description	Number	Name	Description	Compatibility	Precautions for replacement
D9200	LRDP processing results	0: Normal completion 2: LRDP instruction setting fault 3: Error at relevant station 4: Relevant station LRDP execution disabled	None	-	-	△	Delete when used in a sequence program. (Refer to Section 2.6.2 Transient instructions.)
D9201	LWTP processing results	0: Normal completion 2: LWTP instruction setting fault 3: Error at relevant station 4: Relevant station LRDP execution disabled	None	-	-	△	Delete when used in a sequence program. (Refer to Section 2.6.2 Transient instructions.)
D9202	Local station link type	Stores whether or not the normal station is a MELSECNET compatible station or a MELSECNET II compatible station.	None	-	-	△	Delete when used in a sequence program due to MELSECNET/H system.
D9203							
D9241							
D9242							
D9204	Link status	0: Forward loop, during data link 1: Reverse loop, during data link 2: Loopback implemented in forward/reverse directions 3: Loopback implemented in only forward direction 4: Loopback implemented only in reverse direction 5: Data link disabled	SW0049 (SW0090 to SW009A)	Cause of data link transmission stop	0: Normal 1: Stop instruction issued 2: No common parameters 3: Common parameter error 4: Host station CPU error 6: Communication canceled	△	Check whether or not the data link is normally SW0049. (Loop status is judged comprehensively by SW0090 to SW009A.)
D9205	Station implementing loopback	Station that implemented forward loopback	SW0099	Loopback station (forward loop side)	Stores the number of stations executing the loopback on the forward loop side.	○	
D9206	Station implementing loopback	Station that implemented reverse loopback	SW009A	Loopback station (reverse loop side)	Stores the number of stations executing the loopback on the reverse loop side.	○	
D9207	Link scan time	Max. value	SW006B	Link scan time	Max. value	○	
D9208		Min. value	SW006C		Min. value	○	
D9209		Current value	SW006D		Current value	○	
D9210	Retry	Stored as cumulative value	SW00C8	Number of retries on the forward loop side	Accumulates and stores the number of retries on the forward loop side.	△	The retries on the forward loop side are stored as a cumulative value.
			SW00C9	Number of retries on the reverse loop side	Accumulates and stores the number of retries on the reverse loop side.	△	The retries on the reverse loop side are stored as a cumulative value.

(to next page)

○ : Compatible, △ : Partial change required, × : Incompatible

Special register in the case of MELSECNET (II) master station			MELSECNET/H special register				
Number	Name	Description	Number	Name	Description	Compat- ibility	Precautions for replacement
D9211	Loop switching count	Stored as cumulative value	SW00CE	Loop switching count	Accumulates and stores the number of loop checks conducted.	○	
D9212	Local station operation status	Stores local stations in a STOP or PAUSE status.	SW0084	Each station CPU RUN status	Stores the CPU RUN status of each station.	○	
D9213			SW0085				
D9214			SW0086				
D9215			SW0087				
D9216	Local station error detection status	Stores whether each local station has detected any error in other station.	None	-	-	△	Can be substituted by SW0074 to SW0077.
D9217							
D9218							
D9219							
D9220	Local station parameter mismatch	Turns ON when a local station or a remote I/O station has detected an error on the link parameters from the master station.	SW007C	Parameter error status of each station	Stores the parameter status of each station.	○	
D9221			SW007D				
D9222			SW007E				
D9223	Remote I/O station I/O assignment error		SW007F				
D9224	Local station, remote I/O station initial communication underway	Stores stations that are performing communication of link parameters.	SW0078	Parameter communication status of each station	Stores the communication status of each station parameters.	○	
D9225			SW0079				
D9226			SW007A				
D9227			SW007B				
D9228	Local station, remote I/O station error	Stores data link error stations.	SW0074	Cyclic transmission status of each station	Stores the cyclic transmission status of each station.	○	
D9229			SW0075				
D9230			SW0076				
D9231			SW0077				
D9232	Local station and remote I/O station loop error	Stores the station that detected the error on the forward loop line and reverse loop line.	SW0091	Forward loop status of each station	Stores the forward loop status of each station.	△	The error on the loop line of the forward loop is stored.
D9233			SW0092				
D9234			SW0093				
D9235			SW0094	Reverse loop status of each station	Stores the reverse loop status of each station.	△	The error on the loop line of the reverse loop is stored.
D9236			SW0095				
D9237			SW0096				
D9238			SW0097				
D9239			SW0098				
D9240	Number of receive error detection times	Stores cumulative total of receive errors	SW00B8 to SW00C7	Various error counters	Various error counters	△	The error count for each error cause is stored.



3.6.2 Transient instructions

(1) MELSECNET dedicated instruction

Dedicated instructions that were used on MELSECNET must be replaced with the following dedicated instructions on MELSECNET/H.

The following table shows a comparison between dedicated instructions on MELSECNET and dedicated instructions on MELSECNET/H. The table also shows reference items in the Q Corresponding MELSECNET/H Network System Reference Manual (Remote I/O Network). Check these reference items before changing the sequence program.

MELSECNET (II)			MELSECNET/H			NET/H
Instruction name	Category	Description	Instruction name	Category	Description of change	Reference item in the manual
RFRP	Reading data from remote I/O station	The master station reads the data of special modules mounted on remote I/O stations.	REMFR	Reading data from buffer memory on remote I/O station intelligent function modules	Reads data from buffer memory on a target remote I/O station intelligent function module.	Section 7.1.1
RTOP	Writing data to remote I/O station	The master station writes data to special modules mounted on remote I/O stations.	REMTO	Writing data to buffer memory on remote I/O station intelligent function modules	Writes data to buffer memory on a target remote I/O station intelligent function module.	Section 7.1.1

The following describes operation by the instructions.

○ : Can be used, × : Cannot be used

Instruction	Name	Execution station	Description	Target station Remote I/O module
		QCPU		
REMFR	Reading from buffer memory on remote I/O station intelligent function module	○	<p>Reads data from buffer memory on a target remote I/O station intelligent function module.</p>	○
REMTO	Writing to buffer memory on remote I/O station intelligent function module	○	<p>Writes data to buffer memory on a target remote I/O station intelligent function module.</p>	○

3.7 Replacement Precautions

The following shows the replacement precautions when replacing MELSECNET (II) with MELSECNET/H.

(1) Cables

For details on precautions for optical cables and coaxial cables, refer to Section 2.2.2 Cable performance comparisons.

(2) System configuration

(a) System configuration using local stations and remote I/O stations in MELSECNET mode and MELSECNET II mode

MELSECNET/H system, which is a composite system comprising local stations and remote stations, provides high-performance functions by making a separation between local stations and remote stations. It therefore cannot be configured by a mixture of local stations and remote stations. For this reason, in a MELSECNET (II) system, when replacing a system, which comprises a mixture of local stations and remote I/O stations connected to a single master station, with a MELSEC/H system, the following system configuration is necessary. Normal stations are connected to a single control station, and remote I/O stations are controlled by an additional remote master station (the control station in a remote I/O system is defined as the "remote master station"). The following shows a system configuration example.

System configuration using local and remote stations (optical)

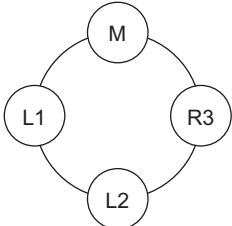
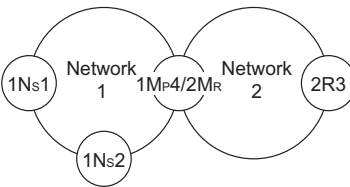
MELSECNET (II) (optical)	MELSECNET/H (optical)	Remarks (proposed measure)
<p>Optical loop</p> 	<p>Optical loop</p> 	<ul style="list-style-type: none"> <li>• The control station of network No.1 configures a PLC to PLC network that controls normal station 1 and normal station 2.</li> <li>• The other network module becomes the remote master station, and the remote I/O network system of No.2 is configured.</li> </ul>

### (3) Sequence program

#### (a) Data separation prevention

When two words (32 bits) or more of cyclic data (e.g. current value of the positioning module) are handled, the old data sometimes is mixed with the new data. To read/write cyclic data of two words or more in a single operation, set data separation prevention by the per-station block guarantee function.

By enabling the per-station block guarantee function, handshaking is performed between CPU modules and network modules to refresh the network and to enable data separation to be prevented in station units. The per-station block guarantee function is enabled when "Secured data send" and "Secured data receive" in the following parameters are set. Enabling the per-station block guarantee function is recommended.

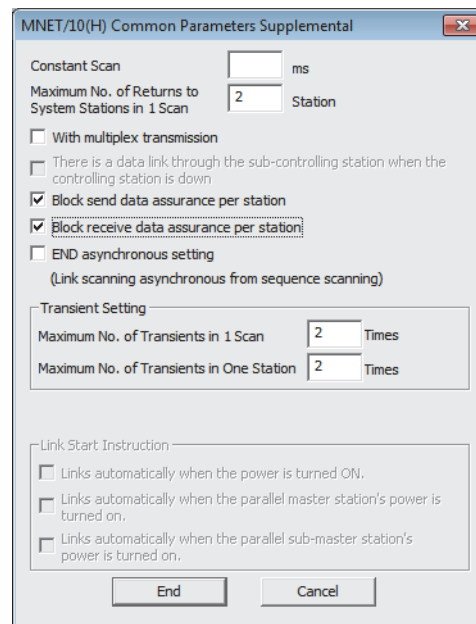

#### (b) I/O assignments

The I/O assignment function is used to reserve and set module information to prevent I/O numbers from deviating even if a module is mounted later on in an empty slot, and to conserve the number of I/O points.

With MELSECNET/H, each of the I/O assignments are set on each remote I/O station. With MELSECNET (II), however, as the I/O assignments of all remote I/O stations were set on the master station CPU. Set the I/O assignments of each remote I/O station again at transition to MELSECNET/H.

Also, as the I/O assignment settings of PLC parameters are not cleared when the programmable controller type is changed (e.g. when A3ACPU is changed to Q06UDVCPU), manually clear the I/O assignment settings for the remote I/O stations.

#### (c) Processing time

The link scan time and link refresh time differ between the A/AnS/QnA/QnAS series and the Q series. For details on processing times, refer to the manual for the respective module.

# 4 REPLACEMENT OF THE MELSECNET/10 (PLC TO PLC NETWORK)

The Q series network modules support the MELSECNET/10 mode (functional and performance compatibility mode) and MELSECNET/H extended mode (high functionality and high-speed mode). This chapter describes the replacement using MELSECNET/10 mode that has the compatibility to the existing network and is used the A, AnS, QnA, and QnAS series CPU modules in combination. For details on the MELSECNET/H mode and MELSECNET/H extended mode, refer to the Q Corresponding MELSECNET/H Network System Reference Manual (PLC to PLC network). the MELSECNET/H mode and MELSECNET/H extended mode can be used when all stations are replaced with the Q series modules.

## 4.1 List of MELSECNET/10 Alternative Models

### (1) Replacement of the A/AnS series

Network type	A/AnS series	Q series
Optical loop	AJ71LP21	QJ71LP21-25
	A1SJ71LP21	
	AJ71LP21G	QJ71LP21G
Coaxial loop	AJ71LR21	QJ71BR11
	A1SJ71LR21	
Coaxial bus	AJ71BR11	
	A1SJ71BR11	

### (2) Replacement of the QnA/QnAS series

Network type	QnA series	Q series
Optical loop	AJ71QLP21	QJ71LP21-25
	A1SJ71QLP21	
	AJ71QLP21S	QJ71LP21S-25
	A1SJ71QLP21S	
	AJ71QLP21G	
Coaxial loop	AJ71QLR21	QJ71BR11
	A1SJ71QLR21	
Coaxial bus	AJ71QBR11	
	A1SJ71QBR11	

## 4.2 Specifications Comparisons

### 4.2.1 Module specifications comparisons

#### (1) Comparison of AJ71LP21/A1SJ71LP21/AJ71QLP21/A1SJ71QLP21 and QJ71LP21-25 (MELSECNET/10 mode)

○ : Compatible, △ : Partial change required, × : Incompatible

Item		Specifications			Compatibility	Precautions for replacement
		AJ71LP21 A1SJ71LP21	AJ71QLP21 A1SJ71QLP21	QJ71LP21-25 MELSECNET/10 mode)		
Maximum number of link points per network	LX/LY	8192 points			○	
	LB	8192 points			○	
	LW	8192 points			○	
Maximum number of link points per station	$\{(LY + LB) \div 8 + (2 \times LW)\} \leq 2000$ bytes			○		
Communication speed	10Mbps			○		
Communication method	Token ring method			○		
Synchronous type	Frame synchronization method			○		
Encoding method	NRZI coding (Non Return to Zero Inverted)			○		
Transmission method	Duplex loop			○		
Transmission format	HDLC standards (frame format)			○		
Maximum number of networks	255 (Total number of PLC to PLC networks and remote I/O networks)	239 (Total number of PLC to PLC networks and remote I/O networks)		△	Network No.240 to No.255 cannot be set. Alternate them with unused network No.	
Maximum number of groups	9			○		
Number of stations connected in one network	64 stations (Control station: 1, normal station: 63)			○		
Applicable cable	SI optical cable, H-PCF optical cable, Broad-band H-PCF optical cable, and QSI optical cable			○		
Overall distance	30km			○		
Distance between stations	SI optical cable: 500m, H-PCF optical cable: 1km, Broad-band H-PCF optical cable: 1km, and QSI optical cable: 1km			○		
Error control system	CRC( $X^{16} + X^{12} + X^5 + 1$ ) and retry by a time over			○		
RAS function	<ul style="list-style-type: none"> <li>• Loop-back function due to error detection or broken cable</li> <li>• Diagnostic function for checking local link lines</li> <li>• Prevention of system down by switching the control station</li> <li>• Abnormal detection using link special relays and link special registers</li> <li>• Network monitoring and various diagnostic functions</li> </ul>			○		
Transient transmission	<ul style="list-style-type: none"> <li>• N:N communication (e.g. monitor, program up/download)</li> <li>• Dedicated link instruction</li> </ul>			△	For comparison of dedicated link instruction, refer to Section 4.6.2.	
Number of occupied I/O points	32 points per slot (I/O assignment: special 32 points)	32 points per slot (I/O assignment: intelli. 32 points)		○		

## (2) Comparison of AJ71QLP21S/A1SJ71QLP21S and QJ71LP21S-25 (MELSECNET/10 mode)

○ : Compatible, △ : Partial change required, × : Incompatible

Item		Specifications		Compatibility	Precautions for replacement
		AJ71LP21/A1SJ71LP21	QJ71LP21-25 (MELSECNET/10 mode)		
Maximum number of link points per network	X/Y	8192 points		○	
	B	8192 points		○	
	W	8192 points		○	
Maximum number of link points per station		$\{(Y + B) \div 8 + (2 \times W)\} \leq 2000$ bytes		○	
Communication speed		10Mbps		○	
Communication method		Token ring method		○	
Synchronous type		Frame synchronization method		○	
Encoding method		NRZI coding (Non Return to Zero Inverted)		○	
Transmission method		Duplex loop		○	
Transmission format		HDLC standards (frame format)		○	
Maximum number of networks		239 (Total number of PLC to PLC networks and remote I/O networks)		○	
Maximum number of groups		9		○	
Number of stations connected in one network		64 stations (Control station: 1, normal station: 63)		○	
Applicable cable		SI optical cable, H-PCF optical cable, Broad-band H-PCF optical cable, and QSI optical cable		○	
Overall distance		30km		○	
Distance between stations		SI optical cable: 500m, H-PCF optical cable: 1km, Broad-band H-PCF optical cable: 1km, and QSI optical cable: 1km		○	
Error control system		CRC( $X^{16} + X^{12} + X^5 + 1$ ) and retry by a time over		○	
RAS function		<ul style="list-style-type: none"> <li>• Loop-back function due to error detection or broken cable</li> <li>• Diagnostic function for checking local link lines</li> <li>• Prevention of system down by switching the control station</li> <li>• Abnormal detection using link special relays and link special registers</li> <li>• Network monitoring and various diagnostic functions</li> </ul>		○	
Transient transmission		<ul style="list-style-type: none"> <li>• N:N communication (e.g. monitor, program up/download)</li> <li>• Dedicated link instruction</li> </ul>	<ul style="list-style-type: none"> <li>• N:N communication (e.g. monitor, program up/download)</li> <li>• Dedicated link instruction</li> </ul>	△	For comparison of dedicated link instruction, refer to Section 4.6.2.
External power supply	Voltage	20.4VDC to 31.2VDC	20.4VDC to 31.2VDC	○	
	Current	0.2A	0.20A	○	
	Applicable cable size	0.75 to 2mm <sup>2</sup>	0.3 to 1.25mm <sup>2</sup>	△	Cables of 1.25mm <sup>2</sup> or more should be replaced with cables of 0.3 to 1.25mm.
Number of occupied I/O points		AJ71QLP21S: 32 points per slot (I/O assignment: special 32 points) A1SJ71QLP21S: 48 points 2 slots (I/O assignment: [first half] empty 16 points, [second half] special 32 points)	48 points 2 slots (I/O assignment: [first half] empty 16 points, [second half] intelli. 32 points)	△	When the AJ71QLP21S is replaced, set the [Empty 16 points] of first half to the [Empty 0 point] with I/O assignment.

### (3) Comparison of AJ71LP21G/AJ71QLP21G and QJ71LP21G (MELSECNET/10 mode)

○ : Compatible, △ : Partial change required, × : Incompatible

Item		Specifications			Compatibility	Precautions for replacement
		AJ71LP21G	AJ71QLP21G	QJ71LP21G (MELSECNET/10 mode)		
Maximum number of link points per network	LX/LY	8192 points			○	
	LB	8192 points			○	
	LW	8192 points			○	
Maximum number of link points per station	$\{(LY + LB) \div 8 + (2 \times LW)\} \leq 2000$ bytes			○		
Communication speed	10Mbps			○		
Communication method	Token ring method			○		
Synchronous type	Frame synchronization method			○		
Encoding method	NRZI coding (Non Return to Zero Inverted)			○		
Transmission method	Duplex loop			○		
Transmission format	HDLC standards (frame format)			○		
Maximum number of networks	255 (Total number of PLC to PLC networks and remote I/O networks)	239 (Total number of PLC to PLC networks and remote I/O networks)		△	Network No.240 to No.250 cannot be set. Alternate them with unused network No.	
Maximum number of groups	9			○		
Number of stations connected in one network	64 stations (Control station: 1, normal station: 63)			○		
Applicable cable	GI optical cable			○		
Overall distance	30km			○		
Distance between stations	GI optical cable: 2km			○		
Error control system	CRC( $X^{16} + X^{12} + X^5 + 1$ ) and retry by a time over			○		
RAS function	<ul style="list-style-type: none"> <li>• Loop-back function due to error detection or broken cable</li> <li>• Diagnostic function for checking local link lines</li> <li>• Abnormal detection using link special relays and link special registers</li> <li>• Network monitoring and various diagnostic functions</li> </ul>			○		
Transient transmission	<ul style="list-style-type: none"> <li>• N:N communication (e.g. monitor, program up/download)</li> <li>• Dedicated link instruction</li> </ul>			△	For comparison of dedicated link instruction, refer to Section 4.6.2.	
Number of occupied I/O points	32 points per slot (I/O assignment: special 32 points)	32 points per slot (I/O assignment: intelli. 32 points)		○		

#### (4) Comparison of AJ71LR21/A1SJ71LR21/AJ71QLR21/A1SJ71QLR21 and QJ71BR11 (MELSECNET/10 mode)

○ : Compatible, △ : Partial change required, × : Incompatible

Item	Specifications			Compatibility	Precautions for replacement
	AJ71LR21 A1SJ71LR21	AJ71QLR21 A1SJ71QLR21	QJ71BR11 (MELSECNET/10 mode)		
Maximum number of link points per network	LX/LY	8192 points		○	
	LB	8192 points		○	
	LW	8192 points		○	
Maximum number of link points per station	$\{(LY + LB) \div 8 + (2 \times LW)\} \leq 2000$ bytes			○	
Communication speed	10Mbps			○	
Communication method	Token ring method		Token bus method	△	Nothing to be noted though the communication method differs.
Synchronous type	Frame synchronization method			○	
Encoding method	Manchester code			○	
Transmission method	Duplex loop		Single bus	△	The loopback function and multiplex transmission function cannot be used on a coaxial bus system. To use the functions, using an optical loop system is recommended.
Transmission format	HDLC standards (frame format)			○	
Maximum number of networks	255 (Total number of PLC to PLC networks and remote I/O networks)	239 (Total number of PLC to PLC networks and remote I/O networks)		△	Network No.240 to No.250 cannot be set. Alternate them with unused network No.
Maximum number of groups	9			○	
Number of stations connected in one network	64 stations (Control station: 1, normal station: 63)		32 stations (Control station: 1, normal station: 31)	△	Normal stations up to 31 stations can be used on a coaxial bus system. To use 32 normal stations or more, using an optical loop system is recommended.
Applicable cable	3C-2V, 5C-2V, 5C-FB			○	
Overall distance	3C-2V: 19.2km 5C-2V, 5C-FB: 30km		3C-2V: 300m 5C-2V, 5C-FB: 500m	△	Either use an A6BR10/A6BR10-DC type repeater unit, or use an optical loop system.
Distance between stations	3C-2V: 300m 5C-2V, 5C-FB: 500m			○	
Error control system	CRC( $X^{16} + X^{12} + X^5 + 1$ ) and retry by a time over			○	



Item	Specifications			Compatibility	Precautions for replacement
	AJ71LR21 A1SJ71LR21	AJ71QLR21 A1SJ71QLR21	QJ71BR11 (MELSECNET/10 mode)		
RAS function	<ul style="list-style-type: none"> <li>• Loop-back function due to error detection or broken cable</li> <li>• Diagnostic function for checking local link lines</li> <li>• Prevention of system down by switching the control station</li> <li>• Abnormal detection using link special relays and link special registers</li> <li>• Network monitoring and various diagnostic functions</li> </ul>		<ul style="list-style-type: none"> <li>• Diagnostic function for checking local link lines</li> <li>• Prevention of system down by switching the control station</li> <li>• Abnormal detection using link special relays and link special registers</li> <li>• Network monitoring and various diagnostic functions</li> </ul>	△	The loopback function cannot be used on a coaxial bus system. To use the loopback function, using an optical loop system is recommended.
Transient transmission	<ul style="list-style-type: none"> <li>• N:N communication (e.g. monitor, program up/download)</li> <li>• Dedicated link instruction</li> </ul>			△	For comparison of dedicated link instruction, refer to Section 4.6.2.
Number of occupied I/O points	32 points per slot (I/O assignment: special 32 points)		32 points per slot (I/O assignment: intelli. 32 points)	○	

### (5) Comparison of AJ71BR11/A1SJ71BR11/ AJ71QBR11/A1SJ71QBR11 and QJ71BR11 (MELSECNET/10 mode)

○: Compatible, △: Partial change required, ×: Incompatible

Item	Specifications			Compatibility	Precautions for replacement
	AJ71BR11 A1SJ71BR11	AJ71QBR11 A1SJ71QBR11	QJ72LP21G (MELSECNET/10 mode)		
Maximum number of link points per network	LX/LY	8192 points		○	
	LB	8192 points		○	
	LW	8192 points		○	
Maximum number of link points per station	$\{(LY + LB) \div 8 + (2 \times LW)\} \leq 2000$ bytes			○	
Communication speed	10Mbps			○	
Communication method	Token bus method			○	
Synchronous type	Frame synchronization method			○	
Encoding method	Manchester code			○	
Transmission method	Single bus			△	
Transmission format	HDLC standards (frame format)			○	
Maximum number of networks	255 (Total number of PLC to PLC networks and remote I/O networks)	239 (Total number of PLC to PLC networks and remote I/O networks)		△	Network No.240 to No.250 cannot be set. Alternate them with unused network No.
Maximum number of groups	9			○	
Number of stations connected in one network	32 stations (Control station: 1, normal station: 31)			○	
Applicable cable	3C-2V, 5C-2V, 5C-FB			○	
Overall distance	3C-2V: 300m			○	
	5C-2V, 5C-FB: 500m				
Distance between stations	3C-2V: 300m			○	
	5C-2V, 5C-FB: 500m				
Error control system	CRC( $X^{16} + X^{12} + X^5 + 1$ ) and retry by a time over			○	
RAS function	<ul style="list-style-type: none"> <li>Diagnostic function for checking local link lines</li> <li>Prevention of system down by switching the control station</li> <li>Abnormal detection using link special relays and link special registers</li> <li>Network monitoring and various diagnostic functions</li> </ul>			○	
Transient transmission	<ul style="list-style-type: none"> <li>N:N communication (e.g. monitor, program up/download)</li> <li>Dedicated link instruction</li> </ul>			△	For comparison of dedicated link instruction, refer to Section 4.6.2.
Number of occupied I/O points	32 points per slot (I/O assignment: special 32 points)		32 points per slot (I/O assignment: intelli. 32 points)	○	

## 4.2.2 Cable performance comparisons

### (1) Optical fiber cable

Overall distance and distance between stations do not differ depending on the optical fiber cable.  
For overall distance and distance between stations, refer to Section 4.2.1.

### (2) Coaxial cable

#### (a) Overall distance

○ : Compatible, △ : Partial change required, × : Incompatible

Type	Specifications			Compat- ibility	Precautions for replacement
	A/AnS/QnA/QnAS series MELSECNET/10 module		Q series MELSECNET/H module (Coaxial bus)		
	Coaxial bus	Coaxial loop			
3C-2V	300m	19.2km	300m	△	Refer to <sup>*1</sup> below
5C-2V	500m	30km	500m	△	Refer to <sup>*1</sup> below

\*1 When the overall distance does not satisfy the MELSECNET/H specifications, either use an A6BR10/A6BR10-DC type repeater unit in the network, or configure a separate network.

#### (b) Distance between stations

○ : Compatible, △ : Partial change required, × : Incompatible

Type	Specifications			Compat- ibility	Precautions for replacement
	A/AnS/QnA/QnAS series MELSECNET/10 module		Q series MELSECNET/H module (Coaxial bus)		
	Coaxial bus	Coaxial loop			
3C-2V	300m	300m	300m	○	
5C-2V	500m	500m	500m	○	

Remarks

The following shows the extension method when a repeater unit for the A6BR10/A6BR10-DC type MELSECNET/10 coaxial bus system is used.

For details, refer to the Repeater Unit for the MELSECNET/10 Coaxial Bus System type A6BR10/A6BR10-DC User's Manual (IB-66499).

(1) The distance between stations of 500m (5C-2V) and 300m (3C-2V) can be extended.

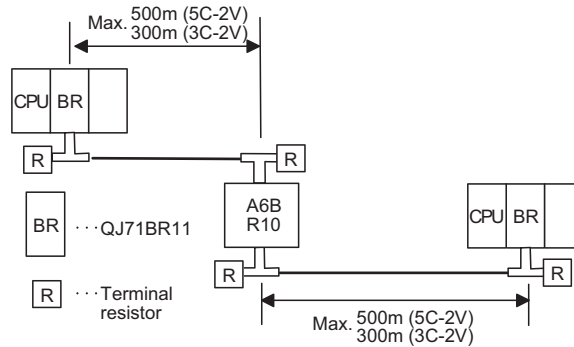

(2) Up to four repeater units can be used in a single network. \*2

The overall distance can be extended to a maximum distance of 2.5 km.

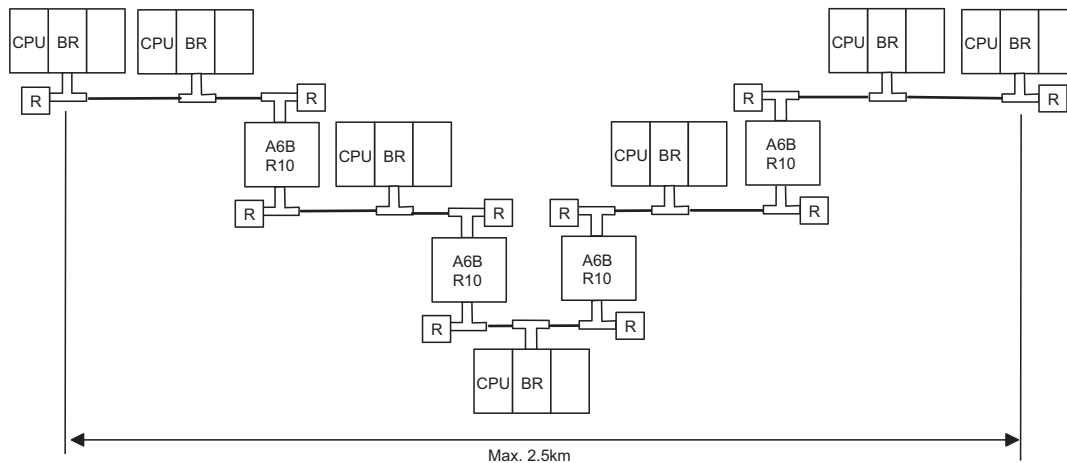

\*2 It is necessary to add terminal resistor A6RCON-R75 (sold separately).

## 4.3 Functional Comparisons

## (1) A/AnS series

○ : Compatible, △ : Partial change required, × : Incompatible

Item	Description		Compat- ibility	Precautions for replacement
	A/AnS series MELSECNET/10 module* <sup>1</sup>	Q series MELSECNET/H module* <sup>2</sup>		
Cyclic transfer function	Communication using B/W (1:N communication)	Performs communications with all stations using link relay and link register. (Communication using B/W)	○	
	Communication using X/Y (1:1 communication)	Performs communications between I/O master station and the other station in pairs. (Communication using X/Y)	○	
	Constant link scan function	Keeps link scan time constant.	○	
	Data link stop/restart function	Stops cyclic transmission temporarily with GX Works2 or GX Developer.	○	
	Inter-link data transfer function	Transfers link data to multiple networks using parameters all at once, when multiple networks are connected to one programmable controller.	○	
Transient transmission function	Transient transmission function	Communicates only when communication requests are issued between each stations. (Communication using dedicated link instruction and GX Works2/GX Developer.)	△	<ul style="list-style-type: none"> <li>LRDP instruction and LWTP instruction cannot be used. Change them to ZNRD instruction, ZNWR instruction, READ instruction and WRITE instruction.</li> <li>For comparison of dedicated link instruction, refer to Section 4.6.2.</li> </ul>
	Routing function	Performs transient transmission to other stations of which network No. are different.	○	
	Group function	Performs transient transmission to all stations in the group with an instruction.	○	
Control station shift function	Enables to continue data link by switching normal station to sub-control station, even if control station is in failure.	○		
Multiplex transmission function	Performs high-speed communication using duplex transmission channel (forward loop/reverse loop).	○		
RAS function	Automatic return function	Returns the station disconnected from data link to the system when it goes to normal status and restarts data link.	○	
	Loopback function	Keeps normal operation between operable stations by disconnecting faulty area at error occurrence such as cable break.	○	
	Station detach function	Keeps normal operation between operable stations except faulty stations and stations switched off.	○	
	Diagnostic function	Checks line conditions of the network and setting conditions of the module.	△	Set diagnostic items for station-to-station test and forward loop/reverse loop test in GX Works2 or GX Developer network parameters.
	Data link status detect function	Detects faulty area with data of link special relay and link special register.	○	

Item	Description		Compat- ibility	Precautions for replacement
	A/AnS series MELSECNET/10 module*1	Q series MELSECNET/H module*2		
Reserved station function	Treats the stations, which are to be connected in the future, as reserved stations. By specifying the stations, which are not connected, as reserved stations, communication error does not occur.		○	

\*1 Use GX Developer.

\*2 Use GX Works2 or GX Developer.

## (2) QnA/QnAS series

○ : Compatible, △ : Partial change required, × : Incompatible

Item	Description		Compat- ibility	Precautions for replacement
	QnA/QnAS series MELSECNET/10 module <sup>*1</sup>	Q series MELSECNET/H module <sup>*2</sup>		
Cyclic transfer function	Communication using B/W	Performs communications with all stations using link relay and link register. (Communication using B/W)	○	
	Communication using X/Y	Performs communications between I/O master station and the other station in pairs. (Communication using X/Y)	○	
	Cyclic transmission stop/restart	Stops cyclic transmission temporarily with GX Works2 or GX Developer.	○	
	Inter-link data transfer function	Transfers link data to multiple networks using parameters all at once, when multiple networks are connected to one programmable controller.	○	
	Direct access to the link devices	Reads/writes directly from/to link device of the network module on the sequence program.	○	
	Increase of sending points by mounting multiple modules of the same network No.	Allows multiple modules, of which the network No. are the same, to be mounted to one programmable controller and increases sending points per one station up to 8000 bytes.	○	
	Default of network refresh parameter	Eliminates the refresh parameters setting by using default values of refresh parameters.	○	
Transient transmission function	Transient transmission function	Communicates only when communication requests are issued between each stations. (Communication using dedicated link instruction and GX Works2/GX Developer.)	○	
	Routing function	Performs transient transmission to other stations of which network No. are different.	○	
	Group function	Performs transient transmission to all stations in the group with an instruction.	○	
	Dedicated link instruction	Performs communications with other station at desired timing using dedicated link instruction.	○	
	Specification of default network	Processes the requests that cannot specify network No. of access path.	○	
	Clock setup for stations on network with peripheral device	Performs clock setup to CPU modules connected to the network with GX Works2 or GX Developer.	○	
Control station shift function	Enables to continue data link by switching normal station to sub-control station, even if control station is in failure.	○		
Multiplex transmission function	Performs high-speed communication using duplex transmission channel (forward loop/reverse loop).	○		
Reserved station function	Treats the stations, which are to be connected in the future, as reserved stations. By specifying the stations, which are not connected, as reserved stations, communication error does not occur.	○		

(To next page)

○ : Compatible, △ : Partial change required, × : Incompatible

Item	Description		Compat- ibility	Precautions for replacement
	QnA/QnAS series MELSECNET/10 module <sup>*1</sup>	Q series MELSECNET/H module <sup>*2</sup>		
Simple dual-structured network	Switches link data refresh target to the standby network to continue data link when break causes error in regular network.		×	For Universal model QCPU, the simple dual-structured system cannot be configured. Configure a single network system.
Using SB/SW as user flag	Sends desired control data to all stations using user-flag status (SW01F0 to SW01F3) without using link device.		△	Change UFSET, UFRST and UFOUT instructions to a sequence program that uses the link relay and link register.
RAS function	Automatic return function	Returns the station disconnected from data link to the system when it goes to normal status and restarts data link.	○	
	Loopback function	Keeps normal operation between operable stations by disconnecting faulty area at error occurrence such as cable break.	○	
	Prevention of station failure by using external power supply	Prevents loopback due to shutdown of programmable controller.	○	
	Station detach function	Keeps normal operation between operable stations except faulty stations and stations switched off.	○	
	Transient transmission available even if programmable controller CPU is in error	Checks the errors for CPU modules of which a stop error occurs, via network from GX Works2 or GX Developer.	○	
	Checking the transient transmission abnormal detection time	Checks error completion time, abnormal detection network number and abnormal detection station number of transient transmission.	○	
	Diagnostic function	Checks line conditions of the network and setting conditions of the module.	△	Set diagnostic items for station-to-station test and forward loop/reverse loop test in GX Works2 or GX Developer network parameters.

\*1 Use GX Developer.

\*2 Use GX Works2 or GX Developer.



## 4.4 Switch Settings Comparisons

○ : Compatible, △ : Partial change required, × : Incompatible

Switch name	Description		Compat- ibility	Precautions for replacement
	A/AnS/QnA/QnAS series MELSECNET/10 module	Q series MELSECNET/H module (MELSECNET/10 mode)		
Network No. setting switch	Sets the network No.	-	△	<ul style="list-style-type: none"> <li>Set in GX Works2 or GX Developer network parameters.</li> <li>Network No.240 to No.255 cannot be set.</li> <li>Alternate them with unused network Nos.</li> </ul>
Group No. setting switch	Sets the group No.	-	△	Set in GX Works2 or GX Developer network parameters.
Mode setting switch	Sets the mode. <Setting range> 0: Online 2: Offline 3: Loop test (forward loop) <sup>*1</sup> 4: Loop test (reverse loop) <sup>*1</sup> 5: Station-to-station test (master station) 6: Station-to-station test (normal station) 7: Self-loopback test 8: Internal self-loopback test 9: H/W test D: Network No. check E: Group No. check F: Station No. check	Sets the mode. <Setting range> 0: Online 1: Self-loopback test 2: Internal self-loopback test 3: hardware test	△	<ul style="list-style-type: none"> <li>Set offline, loop test and station-to-station test in GX Works2 or GX Developer network parameters.</li> <li>Check network No., group No. and station No. in GX Works2 or GX Developer network diagnostics (host information).</li> </ul>
Condition setting switch	Sets the operation conditions.	-	△	This switch cannot make parameter setting. Set in GX Works2 or GX Developer network parameters.

\*1 The QnA/QnAS series support the loop test.

## 4.5 Parameter Comparisons

## (1) Parameter of control station

○ : Compatible, △ : Partial change required, × : Incompatible

Parameter name	Description		Compat- ibility	Precautions for replacement	
	A/AnS/QnA/QnAS series MELSECNET/10 module	Q series MELSECNET/H module (MELSECNET/10 mode)			
Network parameter	Network type		○		
	Starting I/O No.		○		
	Network No.		△	Network No.240 to No.255 cannot be set. Alternate them with unused network Nos.	
	Total number of (normal) stations		○		
	-		△	Set the group No. in GX Works2 or GX Developer network parameters.	
	-		△	Set the mode in GX Works2 or GX Developer network parameters.	
	Network range assignment (common parameter)	Monitoring time	Network range assignment (common parameter)	○	
		LB/LW setting		○	
		LX/LY setting		○	
		I/O master station specification		○	
	Reserved station designation	Reserved station designation	○		
			Supplemental settings	○	
	Station inherent parameter		○		
	Refresh parameters		○		
	Inter-link data transfer		○		
	Routing parameters		○		
Valid module during other station access		○			

## (2) Parameter of normal station

○ : Compatible, △ : Partial change required, ×: Incompatible

Parameter name	Description		Compat- ibility	Precautions for replacement
	A/AnS/QnA/QnAS series MELSECNET/10 module	Q series MELSECNET/H module (MELSECNET/10 mode)		
Network parameter	Network type	Network type	○	
	Starting I/O No.	Starting I/O No.	○	
	Network No.	Network No.	△	Network No.240 to No.255 cannot be set. Alternate them with unused network Nos.
	-	Group No.	△	Set the group No. in GX Works2 or GX Developer network parameters.
	-	Mode	△	Set the mode in GX Works2 or GX Developer network parameters.
	Station inherent parameter	Station inherent parameter	○	
	Refresh parameters	Refresh parameters	○	
	Inter-link data transfer	Inter-link data transfer	○	
	Routing parameters	Routing parameters	○	
	Valid module during other station access	Valid module during other station access	○	

(3) Parameter of standby station<sup>\*1</sup>

○ : Compatible, △ : Partial change required, × : Incompatible

Parameter name	Description		Compat- ibility	Precautions for replacement
	QnA/QnAS series MELSECNET/10 module	Q series MELSECNET/H module (MELSECNET/10 mode)		
Network parameter	Network type	Network type	○	
	Starting I/O No.	Starting I/O No.	○	
	Network No.	Network No.	○	
	-	Group No.	△	Set the group No. in GX Works2 or GX Developer network parameters.
	-	Mode	△	Set the mode in GX Works2 or GX Developer network parameters.
	Standby station compatible module	Standby station compatible module	○	
	Routing parameters	Routing parameters	○	
	Valid module during other station access	Valid module during other station access	○	

- <sup>\*1</sup> Standby station is a station type of simple dual-structured system.  
Only the following CPU modules support the simple dual-structured system.
- Process CPU

## 4.6 Program Comparisons

### 4.6.1 Comparison of link special relay (SB)/link special register (SW)

The table below shows only link special relay (SB) and link special register (SW) to be used in interlock program.

Device name and device No. of MELSECNET/H module are described in link device of internal MELSECNET/H module.

Changing sequence program should be performed after checking the refreshed device of link device in refresh parameters.

#### (1) AnN/AnA/AnSCPU (excluding AnUS(H)CPU)

When MELSECNET/10 module is mounted to the CPU module of the AnN/AnA/AnSCPU (excluding AnUS(H)CPU), link special relay (SB) and link special register (SW) are assigned to special relay and special register of CPU module.

For replacing with a MELSECNET/H module, change sequence program in reference to the following.

#### (a) Link special relay (SB)

○ : Compatible, △ : Partial change required, × : Incompatible

AnN/AnA/AnSCPU MELSECNET/10 module			QCPU MELSECNET/H module			Compat- ibility	Precautions for replacement
Number	Name	Description	Number	Name	Description		
M9204	LRDP instruction complete	OFF : Not completed ON : Completed	-	-	-	△	LRDP instruction cannot be used. When using it in sequence program, delete corresponding part.
M9205	LWTP instruction complete	OFF : Not completed ON : Completed	-	-	-	△	LWTP instruction cannot be used. When using it in sequence program, delete corresponding part.
M9211	Module status	OFF : Normal ON : Abnormal	SB0020	Module status	OFF : Normal ON : Abnormal	○	
M9240	Online host status	OFF : Online ON : Offline, self-loopback test, station-to-station test	SB0043	Online switch (host station)	OFF : Online ON : Other than online	○	
M9241	Forward loop status	OFF : Normal ON : Abnormal	SB0090	Host loop status	OFF : Normal ON : Abnormal	△	When SB0090 turns on, check the loop condition with SW0090, or check by host bit of SW0091 to SW0094.
M9242	Reverse loop status	OFF : Normal ON : Abnormal	SB0090	Host loop status	OFF : Normal ON : Abnormal	△	When SB0090 turns on, check the loop condition with SW0090, or check by host bit of SW0095 to SW0098.
M9243	Loopback status	OFF : Loopback inexecution ON : Loopback execution	SB0090	Host loop status	OFF : Normal ON : Abnormal	△	When SB0090 turns on, check the loop condition with SW0090, or check by SW0099 or SW009A.
M9246	Data not received (Control station)	OFF : Received ON : Not received	-	-	-	△	When using it in sequence program, delete corresponding part.
M9250	Parameter unreceived	OFF : Received ON : Not received	SB0054	Parameter receive status	OFF : Receive completed ON : Unreceived	○	
M9251	Communication status	OFF : Normal ON : Abnormal	SB0049	Host data link status	OFF : Normal ON : Abnormal	○	

(To next page)

○ : Compatible, △ : Partial change required, × : Incompatible

AnN/AnA/AnSCPU MELSECNET/10 module			QCPU MELSECNET/H module			Compat- ibility	Precautions for replacement
Number	Name	Description	Number	Name	Description		
M9252	Loop test status	OFF : Not being executed ON : Forward loop test/reverse loop test execution underway	SB00AE	Offline testing response designation	OFF : No response ON : Response	○	
M9253	Control station operation status	OFF : RUN or STEP RUN ON : STOP or PAUSE	SW0084 to SW0087	Each station CPU RUN status	Stores the CPU RUN status of each station. (Including the host)	○	
M9254	Other station operation status	OFF : All stations are in the RUN or STEP RUN status ON : Any station in the STOP or PAUSE status exist	SB0084	Each station CPU RUN status	OFF : All stations are in the RUN or STEP RUN status ON : Station in the STOP or PAUSE status exist (including the host)	○	
M9255	Other station communication status	OFF : All stations normal ON : Any error station identified	SB0074	Cyclic transmission status of each station	OFF : All stations are executing data linking ON : Stations that are not executing data linking exist	○	

## (b) Link special register (SW)

○ : Compatible, △ : Partial change required, × : Incompatible

AnN/AnA/AnSCPU MELSECNET/10 module			QCPU MELSECNET/H module			Compat- ibility	Precautions for replacement
Number	Name	Description	Number	Name	Description		
D9243	Host station number	Stores the station number of the host.	SW0042	Station No.	Stores the station number of the host.	○	
D9244	Maximum station No.	Stores the maximum station No. set in network parameters.	SW0059	Total number of link stations	Stores the total number of link stations set in network parameters.	○	
D9245	Communication error count	Accumulates and stores the communication error times.	SW00B8 to SW00C7	Error counters	Accumulates and stores the various error time.	△	The error count for each error cause is stored.
D9248 to D9251	Other station CPU RUN status	Stores the CPU RUN status of other station.	SW0084 to SW0087	Each station CPU RUN status	Stores the RUN status of each station. (Including the host)	○	
D9252 to D9255	Data link status of other station	Stores the data link status of other station.	SW0074 to SW0077	Cyclic transmission status of each station	Stores the cyclic transmission status of each station.	○	

**(2) AnU/AnUS(H)/QnA/QnASCPU**

The following device name and device No. are described in link device of internal MELSECNET/10 or MELSECNET/H module.

Changing sequence program should be performed after checking the refreshed device of link device in refresh parameters.

**(a) Link special relay (SB)**

○ : Compatible, △ : Partial change required, × : Incompatible

Item	Number		Compat- ibility	Precautions for replacement
	AnU/AnUS(H)/QnA/ QnASCPU MELSECNET/10 module	QCPU MELSECNET/H module		
Module status	SB0020	SB0020	○	
Baton pass status (host)	SB0047	SB0047	○	
Data link status of each station	SB0049	SB0049	○	
Baton pass status of each station	SB0070	SB0070	○	
Cyclic transmission status of each station	SB0074	SB0074	○	

**(b) Link special register (SW)**

○ : Compatible, △ : Partial change required, × : Incompatible

Item	Number		Compat- ibility	Precautions for replacement
	AnU/AnUS(H)/QnA/ QnASCPU MELSECNET/10 module	QCPU MELSECNET/H module		
Baton pass status of each station	SW0070 to SW0073	SW0070 to SW0073	○	
Cyclic transmission status of each station	SW0074 to SW0077	SW0074 to SW0077	○	

**Remarks**

For link special relay (SB) and link special register (SW) that are not described in this section, refer to each manual.

## 4.6.2 Comparison of dedicated instructions

## (1) A/AnSCPU

○ : Compatible, △ : Partial change required, × : Incompatible

Instruction name	Description		Compat- ibility	Precautions for replacement
	A/AnSCPU MELSECNET/10 module	QCPU MELSECNET/H module (MELSECNET/10 mode)		
ZNRD instruction	Reads the device data of other station.		△	Instruction format differs. Change the sequence program.
ZNWR instruction	Writes data to the device of other station.		△	Instruction format differs. Change the sequence program.
LRDP instruction	Reads the device data of other station only by station number designation.	-	△	LRDP instruction cannot be used. Change them to ZNRD or READ instruction.
LWTP instruction	Writes data to the device of other station only by station number designation.	-	△	LWTP instruction cannot be used. Change them to ZNWR or WRITE instruction.

## (2) QnA/QnASCPU

○ : Compatible, △ : Partial change required, × : Incompatible

Instruction name	Description		Compat- ibility	Precautions for replacement
	QnA/QnASCPU MELSECNET/10 module	QCPU MELSECNET/H module (MELSECNET/10 mode)		
SEND instruction	Sends data to target station.		○	
RECV instruction	Reads data sent by SEND instruction to device of CPU module.		○	
READ instruction, SREAD instruction	Reads the device data of other station.		○	
WRITE instruction, SWRITE instruction	Writes data to the device of other station.		○	
REQ instruction	Issues "remote RUN" and "clock data read/write" requests to other stations.		○	
ZNRD instruction	Reads the device data of other station.		○	
ZNWR instruction	Writes data to the device of other station.		○	
UFSET instruction	Turns user-flag which is corresponding to the host on.	-	△	Change to a sequence program that uses the link relay and link register.
UFRST instruction	Turns user-flag which is corresponding to the host off.	-	△	Change to a sequence program that uses the link relay and link register.
UFOUT instruction	Turns user-flag which is corresponding to the host on/off.	-	△	Change to a sequence program that uses the link relay and link register.



(3) Q series dedicated link instruction list

The table below shows the dedicated link instructions usable in Q series.

For instruction format of dedicated link instruction and precautions, refer to the following manual.

- Q corresponding MELSECNET/H Network System Reference Manual (PLC to PLC network)

○ : Can be used by both the control and normal stations, × : Cannot be used

Instruction	Name	Execution station		Description	Target station		
		QCPU			QCPU	QnA/ QnAS CPU	AnU/ AnUS(H) CPU
SEND	Data sending	○		SEND:Writes data to the target station (network module) having the target network number. RECV:Reads data sent with SEND to the CPU device.	○	○	×
RECV	Data receiving	○			○	○	×
READ SREAD	Other station word device read	○		<p>Reads the CPU device data (in 16-bit units) from the target station having the target network number.</p>	○	○	×
WRITE SWRITE	Other station word device write	○		<p>Writes data (in 16-bit units) to the CPU device of the target station having the target network number. (SWRITE can turn on the device of the target station.)</p>	○	○	×
REQ	Requesting transient transmission to other stations	○		<p>Issues "remote RUN" and "clock data read/write" requests to other stations.</p>	○	○	×

(To next page)

○ : Can be used by both the control and normal stations, × : Cannot be used

Instruction	Name	Execution station		Description	Target station		
		QCPU			QCPU	QnA/ QnAS CPU	AnU/ AnUS(H) CPU
RECVS	Receive message (completed in 1 scan)	○		<p>Receives the channel data sent with SEND by the interrupt program and immediately reads it to the CPU device. The processing is completed when the instruction is executed.</p>	○	○	×
ZNRD	Other station word device read	○		<p>[A-compatible instruction] Reads the CPU device data from the target station having the target network number.</p>	○	○	○*1 AnACPU AnNCPU
ZNWR	Other station word device write	○		<p>[A-compatible instruction] Writes data to the CPU device of the target station having the target network number.</p>	○	○	○*1 AnACPU AnNCPU
RRUN	Remote RUN	○		<p>"Remote RUN" performed for other stations' CPU modules</p>	○	×	×

(To next page)

\*1 CPU modules of the following version or later when the target station is the A2UCPU(S1), A3UCPU, A4UCPU, or A2USCPU(S1)

- A2UCPU(S1), A3UCPU, A4UCPU: Version AY (manufactured in July 1995) or later
- A2USCPU(S1): Version CP (manufactured in July 1995) or later

○ : Can be used by both the control and normal stations, × : Cannot be used

Instruction	Name	Execution station	Description	Target station		
		QCPU		QnA/ QnAS CPU	AnU/ AnUS(H) CPU	
RSTOP	Remote STOP	○	<p>"Remote STOP" performed for other stations' CPU modules</p>	○	×	×
RTMRD	Other station clock data read	○	<p>"Read Clock Data" performed for other stations' CPU modules</p>	○	×	×
RTMWR	Other station clock data written	○	<p>"Write Clock Data" performed for other stations' CPU modules</p>	○	×	×

## 4.7 Other Precautions

### (1) Processing time

The link scan time and link refresh time differ between the A/AnS/QnA/QnAS series and the Q series. For details on processing times, refer to the manual for the respective module.

### (2) A/AnS series replacement precautions

Normal station of MELSECNET/H module requires network parameter setting. For replacement with the QCPU and the MELSECNET/H module, newly set network parameters.

# 5 REPLACEMENT OF THE MELSECNET/10 (REMOTE I/O NETWORK)

## 5.1 Replacing MELSECNET/10 with MELSECNET/H

All stations of the existing A series are replaced with those of the Q series by changing MELSECNET/10 into MELSECNET/H.

### 5.1.1 List of MELSECNET/10 alternative models

#### (1) Replacement of the A/AnS series

Network type	Station type	A/AnS series	Q series
Optical loop	Remote master station	AJ71LP21	QJ71LP21-25
		A1SJ71LP21	
		AJ71LP21G	QJ71LP21G
	Remote I/O station	AJ72LP25	QJ72LP25-25
		AJ72QLP25	
		A1SJ72QLP25	
AJ72LP25G		QJ72LP25G	
Coaxial loop	Remote master station	AJ71LR21	QJ71BR11
		A1SJ71LR21	
	Remote I/O station	AJ72LR25	QJ72BR15
		AJ72QLR25	
		A1SJ72QLR25	
	Coaxial bus	Remote master station	AJ71BR11
A1SJ71BR11			
Remote I/O station		AJ72BR15	QJ72BR15
		AJ72QBR15	
		A1SJ72QBR15	

## (2) Replacement of the QnA/QnAS series

Network type	Station type	QnA/QnAS series	Q series
Optical loop	Remote master station	AJ71QLP21	QJ71LP21-25
		A1SJ71QLP21	
		AJ71QLP21S	QJ71LP21S-25
		A1SJ71QLP21S	
	Remote I/O station	AJ71QLP21G	QJ71LP21G
		AJ72QLP25	QJ72LP25-25
A1SJ72QLP25			
AJ72QLP25G	QJ72LP25G		
Coaxial loop	Remote master station	AJ71QLR21	QJ71BR11
		A1SJ71QLR21	
	Remote I/O station	AJ72QLR25	QJ72BR15
Coaxial bus	Remote master station	AJ71QBR11	QJ71BR11
		A1SJ71QBR11	
	Remote I/O station	AJ72QBR15	QJ72BR15
		A1SJ72QBR15	

## Remarks

System configuration in MELSECNET/10 and MELSECNET/H (remote I/O network)

The following table lists CPU modules that can be installed on MELSECNET/10 and MELSECNET/H (remote I/O network). (The table shows in the case using a module for optical loop. The same applies in the case using a module for a coaxial loop/coaxial bus.)

Master station		Remote I/O station		
CPU module	Network module	QJ72LP25-25	A(1S)J72LP25	A(1S)J72QLP25
QnUCPU	QJ71LP21-25	○ (MELSECNET/H mode)		×
QnA/QnASCPU	A(1S)J71QLP21	○ <sup>*1</sup> (MELSECNET/10 mode)		○
AnU/AnUS(H)CPU	A(1S)J71LP21	○ <sup>*1</sup> (MELSECNET/10 mode)		○
AnN/AnA/AnSCPU (excluding AnUS(H)CPU)	Master station on the remote I/O network cannot be used.	-		-

\*1 The module with a serial number (first five digits) of "15012" or later can be used. For replacement using MELSECNET/10 mode, refer to Section 5.2.

## 5.1.2 Specifications comparisons

### (1) Module specifications comparisons

#### (a) Performance comparison of remote master station

##### 1) Comparison of AJ71LP21/A1SJ71LP21/AJ71QLP21/A1SJ71QLP21 and QJ71LP21-25

○ : Compatible, △ : Partial change required, × : Incompatible

Item		Specifications			Compatibility	Precautions for replacement
		AJ71LP21 A1SJ71LP21	AJ71QLP21 A1SJ71QLP21	QJ71LP21-25		
Maximum number of link points per network	LX/LY	8192 points			○	
	LB	8192 points		16384 points* <sup>1</sup>	○	
	LW	8192 points		16384 points* <sup>1</sup>	○	
Maximum number of link points per station	<Remote master station → remote I/O station> $\{(LY + LB) \div 8 + (2 \times LW)\} \leq 1600$ bytes	<Remote master station → remote I/O station>* <sup>2</sup> $\{(LY + LB) \div 8 + (2 \times LW)\} \leq 1600$ bytes			○	
	<Remote I/O station → remote master station> $\{(LY + LB) \div 8 + (2 \times LW)\} \leq 1600$ bytes	<Remote I/O station → remote master station>* <sup>2</sup> $\{(LY + LB) \div 8 + (2 \times LW)\} \leq 1600$ bytes <Multiplexed remote master station → multiplexed remote sub-master station> $\{(LY + LB) \div 8 + (2 \times LW)\} \leq 2000$ bytes				
Communication speed	10Mbps		25Mbps/10Mbps		○	
Communication method	Token ring method			○		
Synchronous type	Frame synchronization method			○		
Encoding method	NRZI coding (Non Return to Zero Inverted)			○		
Transmission method	Duplex loop			○		
Transmission format	HDLC standards (frame format)			○		
Maximum number of networks	255 (Total number of PLC to PLC networks and remote I/O networks)	239 (Total number of PLC to PLC networks and remote I/O networks)		△	Network No.240 to No.250 cannot be set. Alternate them with unused network No.	
Number of stations connected in one network	65 stations (Remote master station: 1, remote I/O station: 64)* <sup>3</sup>			○		
Applicable cable	SI optical cable, H-PCF optical cable, Broad-band H-PCF optical cable, and QSI optical cable			○		
Overall distance	30km			○		
Distance between stations	SI optical cable: 500m, H-PCF optical cable: 1km, Broad-band H-PCF optical cable: 1km, and QSI optical cable: 1km	<10Mbps> SI optical cable: 500m, H-PCF optical cable: 1km, Broad-band H-PCF optical cable: 1km, and QSI optical cable: 1km		○		
		<25Mbps> SI optical cable: 200m, H-PCF optical cable: 400m, Broad-band H-PCF optical cable: 1km, and QSI optical cable: 1km		△	Use 10 Mbps when using SI optical cable and HPCF optical cable.	
Error control system	CRC ( $X^{16}+X^{12}+X^5+1$ ) and retry by a time over			○		
RAS function	<ul style="list-style-type: none"> <li>• Loop-back function due to error detection or broken cable</li> <li>• Diagnostic function for checking local link lines</li> <li>• Abnormal detection using link special relays and link special registers</li> <li>• Network monitoring and various diagnostic functions</li> </ul>			○		
Transient transmission	<ul style="list-style-type: none"> <li>• Monitor, program up/download with peripheral device</li> <li>• Dedicated link instruction</li> <li>• Available for Intelligent function module (only AJ71QLP21/A1SJ71QLP21)</li> </ul>	<ul style="list-style-type: none"> <li>• 1:1 communication (Monitor, program up/download)</li> <li>• Dedicated link instruction</li> </ul>		△	For comparison of dedicated link instruction, refer to Section 5.1.7.	
Number of occupied I/O points	32 points per slot (I/O assignment: special 32 points)		32 points per slot (I/O assignment: intelli. 32 points)	○		

- \*1 Remote master station → remote sub-master station, remote I/O station: 8192 points  
Remote sub-master station, remote I/O station → remote master station: 8192 points
- \*2 The remote master station includes the multiplexed remote master station and multiplexed remote sub-master station.
- \*3 For the multiplexed remote I/O network, one station in 64 stations of the remote I/O station is used for the multiplexed remote sub-master station.



## 2) Comparison of AJ71QLP21S/A1SJ71QLP21S and QJ71LP21S-25

○ : Compatible, △ : Partial change required, × : Incompatible

Item	Specifications		Compati- bility	Precautions for replacement
	AJ71QLP21S A1SJ71QLP21S	QJ71LP21S-25		
Maximum number of link points per network	LX/LY	8192 points	○	
	LB	8192 points	16384 points*1	○
	LW	8192 points	16384 points*1	○
Maximum number of link points per station	<Remote master station → remote I/O station> $\{(LY + LB) \div 8 + (2 \times LW)\} \leq 1600$ bytes <Remote I/O station → remote master station>*2 $\{(LY + LB) \div 8 + (2 \times LW)\} \leq 1600$ bytes <Multiplexed remote master station ↔ multiplexed remote sub-master station> $\{(LY + LB) \div 8 + (2 \times LW)\} \leq 2000$ bytes	<Remote master station → remote I/O station>*2 $\{(LY + LB) \div 8 + (2 \times LW)\} \leq 1600$ bytes <Remote I/O station → remote master station>*2 $\{(LY + LB) \div 8 + (2 \times LW)\} \leq 1600$ bytes <Multiplexed remote master station ↔ multiplexed remote sub-master station> $\{(LY + LB) \div 8 + (2 \times LW)\} \leq 2000$ bytes	○	
Communication speed	10Mbps	25Mbps/10Mbps	○	
Communication method	Token ring method		○	
Synchronous type	Frame synchronization method		○	
Encoding method	NRZI coding (Non Return to Zero Inverted)		○	
Transmission method	Duplex loop		○	
Transmission format	HDLC standards (frame format)		○	
Maximum number of networks	239 (Total number of PLC to PLC networks and remote I/O networks)		○	
Number of stations connected in one network	65 stations (Remote master station: 1, remote I/O station: 64)*3		○	
Applicable cable	SI optical cable, H-PCF optical cable, Broad-band H-PCF optical cable, and QSI optical cable		○	
Overall distance	30km		○	
Distance between stations	SI optical cable: 500m, H-PCF optical cable: 1km, Broad-band H-PCF optical cable: 1km, and QSI optical cable: 1km	<10Mbps> SI optical cable: 500m, H-PCF optical cable: 1km, Broad-band H-PCF optical cable: 1km, and QSI optical cable: 1km	○	
		<25Mbps> SI optical cable: 200m, H-PCF optical cable: 400m, Broad-band H-PCF optical cable: 1km, and QSI optical cable: 1km	△	Use 10 Mbps when using SI optical cable and HPCF optical cable.
Error control system	CRC ( $X^{16}+X^{12}+X^5+1$ ) and retry by a time over		○	
RAS function	<ul style="list-style-type: none"> <li>• Loop-back function due to error detection or broken cable</li> <li>• Diagnostic function for checking local link lines</li> <li>• Abnormal detection using link special relays and link special registers</li> <li>• Network monitoring and various diagnostic functions</li> </ul>		○	
Transient transmission	<ul style="list-style-type: none"> <li>• Monitor, program up/download with peripheral device</li> <li>• Available for Intelligent function module</li> <li>• Dedicated link instruction</li> </ul>	<ul style="list-style-type: none"> <li>• 1:1 communication (Monitor, program up/download)</li> <li>• Dedicated link instruction</li> </ul>	△	For comparison of dedicated link instruction, refer to Section 5.1.7.
External power supply	Voltage	20.4VDC to 31.2VDC		○
	Current	0.2A		○
	Applicable cable size	0.75 to 2mm <sup>2</sup>	0.3 to 1.25mm <sup>2</sup>	△

Item	Specifications		Compati- bility	Precautions for replacement
	AJ71QLP21S A1SJ71QLP21S	QJ71LP21S-25		
Number of occupied I/O points	AJ71QLP21S: 32 points per slot (I/O assignment: special 32 points) A1SJ71QLP21S: 48 points 2 slots (I/O assignment: [first half] empty 16 points, [second half] special 32 points)	48 points 2 slots (I/O assignment: [first half] empty 16 points, [second half] intelli. 32 points)	△	When the AJ71QLP21S is replaced, set the [Empty 16 points] of first half to the [Empty 0 point] with I/O assignment.

- \*1 Remote master station → remote sub-master station, remote I/O station: 8192 points  
Remote sub-master station, remote I/O station → remote master station: 8192 points
- \*2 The remote master station includes the multiplexed remote master station and multiplexed remote sub-master station.
- \*3 For the multiplexed remote I/O network, one station in 64 stations of the remote I/O station is used for the multiplexed remote sub-master station.

## 3) Comparison of AJ71LP21G/AJ71QLP21G and QJ71LP21G

○ : Compatible, △ : Partial change required, × : Incompatible

Item	Specifications			Compatibility	Precautions for replacement
	AJ71LP21G	AJ71QLP21G	QJ71LP21G		
Maximum number of link points per network	LX/LY	8192 points		○	
	LB	8192 points	16384 points <sup>*1</sup>	○	
	LW	8192 points	16384 points <sup>*1</sup>	○	
Maximum number of link points per station	<Remote master station → remote I/O station> $\{(LY + LB) \div 8 + (2 \times LW)\} \leq 1600$ bytes <Remote I/O station → remote master station> $\{(LY + LB) \div 8 + (2 \times LW)\} \leq 1600$ bytes	<Remote master station → remote I/O station> <sup>*2</sup> $\{(LY + LB) \div 8 + (2 \times LW)\} \leq 1600$ bytes <Remote I/O station → remote master station> <sup>*2</sup> $\{(LY + LB) \div 8 + (2 \times LW)\} \leq 1600$ bytes <Multiplexed remote master station → multiplexed remote sub-master station> $\{(LY + LB) \div 8 + (2 \times LW)\} \leq 2000$ bytes		○	
Communication speed	10Mbps			○	
Communication method	Token ring method			○	
Synchronous type	Frame synchronization method			○	
Encoding method	NRZI coding (Non Return to Zero Inverted)			○	
Transmission method	Duplex loop			○	
Transmission format	HDLC standards (frame format)			○	
Maximum number of networks	255 (Total number of PLC to PLC networks and remote I/O networks)	239 (Total number of PLC to PLC networks and remote I/O networks)		△	Network No.240 to No.250 cannot be set. Alternate them with unused network No.
Number of stations connected in one network	65 stations (Remote master station: 1, remote I/O station: 64) <sup>*3</sup>			○	
Applicable cable	GI optical cable			○	
Overall distance	30km			○	
Distance between stations	GI optical cable: 2km			○	
Error control system	CRC ( $X^{16}+X^{12}+X^5+1$ ) and retry by a time over			○	
RAS function	<ul style="list-style-type: none"> <li>• Loop-back function due to error detection or broken cable</li> <li>• Diagnostic function for checking local link lines</li> <li>• Abnormal detection using link special relays and link special registers</li> <li>• Network monitoring and various diagnostic functions</li> </ul>			○	
Transient transmission	<ul style="list-style-type: none"> <li>• Monitor, program up/download with peripheral device</li> <li>• Dedicated link instruction</li> <li>• Available for Intelligent function module (only AJ71QLP21G)</li> </ul>	<ul style="list-style-type: none"> <li>• 1:1 communication (Monitor, program up/download)</li> <li>• Dedicated link instruction</li> </ul>		△	For comparison of dedicated link instruction, refer to Section 5.1.7.
Number of occupied I/O points	32 points per slot (I/O assignment: special 32 points)		32 points per slot (I/O assignment: intelli. 32 points)	○	

\*1 Remote master station → remote sub-master station, remote I/O station: 8192 points  
 Remote sub-master station, remote I/O station → remote master station: 8192 points

\*2 The remote master station includes the multiplexed remote master station and multiplexed remote sub-master station.

\*3 For the multiplexed remote I/O network, one station in 32 stations of the remote I/O station is used for the multiplexed remote sub-master station.

## 4) Comparison of AJ71LR21/A1SJ71LR21/AJ71QLR21/A1SJ71QLR21 and QJ71BR11

○ : Compatible, △ : Partial change required, × : Incompatible

Item	Specifications			Compatibility	Precautions for replacement
	AJ71LR21 A1SJ71LR21	AJ71QLR21 A1SJ71QLR21	QJ71BR11		
Maximum number of link points per network	LX/LY	8192 points		○	
	LB	8192 points	16384 points* <sup>1</sup>	○	
	LW	8192 points	16384 points* <sup>1</sup>	○	
Maximum number of link points per station	<Remote master station → remote I/O station> $\{(LY + LB) \div 8 + (2 \times LW)\} \leq 1600$ bytes <Remote I/O station → remote master station> $\{(LY + LB) \div 8 + (2 \times LW)\} \leq 1600$ bytes	<Remote master station → remote I/O station>* <sup>2</sup> $\{(LY + LB) \div 8 + (2 \times LW)\} \leq 1600$ bytes <Remote I/O station → remote master station>* <sup>2</sup> $\{(LY + LB) \div 8 + (2 \times LW)\} \leq 1600$ bytes <Multiplexed remote master station → multiplexed remote sub-master station> $\{(LY + LB) \div 8 + (2 \times LW)\} \leq 2000$ bytes		○	
Communication speed	10Mbps			○	
Communication method	Token ring method		Token bus method	△	Nothing to be noted though the communication method differs.
Synchronous type	Frame synchronization method			○	
Encoding method	Manchester code			○	
Transmission method	Duplex loop		Single bus	△	The loopback function and multiplex transmission function cannot be used on a coaxial bus system. To use the functions, using an optical loop system is recommended.
Transmission format	HDLC standards (frame format)			○	
Maximum number of networks	255 (Total number of PLC to PLC networks and remote I/O networks)	239 (Total number of PLC to PLC networks and remote I/O networks)		△	Network No.240 to No.250 cannot be set. Alternate them with unused network No.
Number of stations connected in one network	65 stations (Remote master station: 1, remote I/O station: 64)	33 stations (Remote master station: 1, remote I/O station: 32)* <sup>3</sup>		△	Normal stations up to 32 stations can be used on a coaxial bus system. To use 33 normal stations or more, using an optical loop system is recommended.
Applicable cable	3C-2V, 5C-2V, 5C-FB			○	
Overall distance	3C-2V: 19.2km 5C-2V, 5C-FB: 30km		3C-2V: 300m 5C-2V, 5C-FB: 500m	△	Either use an A6BR10/A6BR10-DC type repeater unit, or use an optical loop system.
Distance between stations	3C-2V: 300m 5C-2V, 5C-FB: 500m			○	
Error control system	CRC( $X^{16} + X^{12} + X^5 + 1$ ) and retry by a time over			○	
RAS function	<ul style="list-style-type: none"> <li>• Loop-back function due to error detection or broken cable</li> <li>• Diagnostic function for checking local link lines</li> <li>• Abnormal detection using link special relays and link special registers</li> <li>• Network monitoring and various diagnostic functions</li> </ul>	<ul style="list-style-type: none"> <li>• Diagnostic function for checking local link lines</li> <li>• Abnormal detection using link special relays and link special registers</li> <li>• Network monitoring and various diagnostic functions</li> </ul>		△	The loopback function cannot be used on a coaxial bus system. To use the loopback function, using an optical loop system is recommended.
Transient transmission	<ul style="list-style-type: none"> <li>• Monitor, program up/download with peripheral device</li> <li>• Dedicated link instruction</li> <li>• Available for Intelligent function module (only AJ71QLR21/A1SJ71QLR21)</li> </ul>	<ul style="list-style-type: none"> <li>• 1:1 communication (Monitor, program up/download)</li> <li>• Dedicated link instruction</li> </ul>		△	For comparison of dedicated link instruction, refer to Section 5.1.7.
Number of occupied I/O points	32 points per slot (I/O assignment: special 32 points)		32 points per slot (I/O assignment: intelli. 32 points)	○	

- \*1 Remote master station → remote sub-master station, remote I/O station: 8192 points  
Remote sub-master station, remote I/O station → remote master station: 8192 points
- \*2 The remote master station includes the multiplexed remote master station and multiplexed remote sub-master station.
- \*3 For the multiplexed remote I/O network, one station in 32 stations of the remote I/O station is used for the multiplexed remote sub-master station.

## 5) Comparison of AJ71BR11/A1SJ71BR11/AJ71QBR11/A1SJ71QBR11 and QJ71BR11

○: Compatible, △: Partial change required, ×: Incompatible

Item	Specifications			Compatibility	Precautions for replacement
	AJ71BR11 A1SJ71BR11	AJ71QBR11 A1SJ71QBR11	QJ71BR11		
Maximum number of link points per network	LX/LY	8192 points		○	
	LB	8192 points	16384 points*1	○	
	LW	8192 points	16384 points*1	○	
Maximum number of link points per station	<Remote master station → remote I/O station> $\{(LY + LB) \div 8 + (2 \times LW)\} \leq 1600$ bytes <Remote I/O station → remote master station> $\{(LY + LB) \div 8 + (2 \times LW)\} \leq 1600$ bytes	<Remote master station → remote I/O station>*2 $\{(LY + LB) \div 8 + (2 \times LW)\} \leq 1600$ bytes <Remote I/O station → remote master station>*2 $\{(LY + LB) \div 8 + (2 \times LW)\} \leq 1600$ bytes <Multiplexed remote master station → multiplexed remote sub-master station> $\{(LY + LB) \div 8 + (2 \times LW)\} \leq 2000$ bytes		○	
Communication speed	10Mbps			○	
Communication method	Token bus method			○	
Synchronous type	Frame synchronization method			○	
Encoding method	Manchester code			○	
Transmission method	Single bus			○	
Transmission format	HDLC standards (frame format)			○	
Maximum number of networks	255 (Total number of PLC to PLC networks and remote I/O networks)	239 (Total number of PLC to PLC networks and remote I/O networks)		△	Network No.240 to No.250 cannot be set. Alternate them with unused network No.
Number of stations connected in one network	33 stations (Remote master station: 1, remote I/O station: 32)*3			○	
Applicable cable	3C-2V, 5C-2V, 5C-FB			○	
Overall distance	3C-2V: 300m 5C-2V, 5C-FB: 500m			○	
Distance between stations	3C-2V: 300m 5C-2V, 5C-FB: 500m			○	
Error control system	CRC( $X^{16} + X^{12} + X^5 + 1$ ) and retry by a time over			○	
RAS function	<ul style="list-style-type: none"> <li>Diagnostic function for checking local link lines</li> <li>Abnormal detection using link special relays and link special registers</li> <li>Network monitoring and various diagnostic functions</li> </ul>			○	
Transient transmission	<ul style="list-style-type: none"> <li>Monitor, program up/download with peripheral device</li> <li>Dedicated link instruction</li> <li>Available for Intelligent function module (only AJ71QBR11/A1SJ71QBR11)</li> </ul>	<ul style="list-style-type: none"> <li>1:1 communication (Monitor, program up/download)</li> <li>Dedicated link instruction</li> </ul>		△	For comparison of dedicated link instruction, refer to Section 5.1.7.
Number of occupied I/O points	32 points per slot (I/O assignment: special 32 points)	32 points per slot (I/O assignment: intelli. 32 points)		○	

\*1 Remote master station → remote sub-master station, remote I/O station: 8192 points

Remote sub-master station, remote I/O station → remote master station: 8192 points

\*2 The remote master station includes the multiplexed remote master station and multiplexed remote sub-master station.

\*3 For the multiplexed remote I/O network, one station in 32 stations of the remote I/O station is used for the multiplexed remote sub-master station.

## (b) Performance comparison of remote I/O stations

## 1) Comparison between AJ72LP25/AJ72QLP25/A1SJ72QLP25 and QJ72LP25-25

○ : Compatible, △ : Partial change required, × : Incompatible

Item		Specifications			Compatibility	Precautions for replacement
		AJ72LP25	AJ72QLP25 A1SJ72QLP25	QJ72LP25-25		
Maximum number of link points per network	LX/LY	8192 points			○	
	LB	8192 points		16384 points* <sup>1</sup>	○	
	LW	8192 points		16384 points* <sup>1</sup>	○	
Maximum number of link points per station	<Remote master station → remote I/O station> $\{(LY + LB) \div 8 + (2 \times LW)\} \leq 1600$ bytes <Remote I/O station → remote master station> $\{(LY + LB) \div 8 + (2 \times LW)\} \leq 1600$ bytes		<Remote master station → remote I/O station>* <sup>2</sup> $\{(LY + LB) \div 8 + (2 \times LW)\} \leq 1600$ bytes <Remote I/O station → remote master station>* <sup>2</sup> $\{(LY + LB) \div 8 + (2 \times LW)\} \leq 1600$ bytes		○	
Maximum number of I/O points per remote I/O station	$X + Y \leq 2048$ points	$X + Y \leq 2048$ points* <sup>4</sup>	$X + Y \leq 4096$ points* <sup>3</sup>		△	
Communication speed	10Mbps		25Mbps/10Mbps		○	
Communication method	Token ring method			○		
Synchronous type	Frame synchronization method			○		
Encoding method	NRZI coding (Non Return to Zero Inverted)			○		
Transmission method	Duplex loop			○		
Transmission format	HDLC standards (frame format)			○		
Maximum number of networks	255 (Total number of PLC to PLC networks and remote I/O networks)	239 (Total number of PLC to PLC networks and remote I/O networks)		△	Network No.240 to No.250 cannot be set. Alternate them with unused network No.	
Number of stations connected in one network	65 stations (Remote master station: 1, remote I/O station: 64)* <sup>5</sup>			○		
Applicable cable	SI optical cable, H-PCF optical cable, Broad-band H-PCF optical cable, and QSI optical cable			○		
Overall distance	30km			○		
Distance between stations	SI optical cable: 500m, H-PCF optical cable: 1km, Broad-band H-PCF optical cable: 1km, and QSI optical cable: 1km		<10Mbps> SI optical cable: 500m, H-PCF optical cable: 1km, Broad-band H-PCF optical cable: 1km, and QSI optical cable: 1km	○		
			<25Mbps> SI optical cable: 200m, H-PCF optical cable: 400m, Broad-band H-PCF optical cable: 1km, and QSI optical cable: 1km	△	Use 10 Mbps when using SI optical cable and HPCF optical cable.	
Error control system	CRC ( $X^{16}+X^{12}+X^5+1$ ) and retry by a time over			○		
RAS function	<ul style="list-style-type: none"> <li>• Loop-back function due to error detection or broken cable</li> <li>• Diagnostic function for checking local link lines</li> <li>• Abnormal detection using link special relays and link special registers</li> <li>• Network monitoring and various diagnostic functions</li> </ul>			○		
Transient transmission	<ul style="list-style-type: none"> <li>• Monitor, program up/download with peripheral device</li> <li>• Dedicated link instruction</li> <li>• Available for Intelligent function module (only AJ72QLP25/A1SJ72QLP25)</li> </ul>	<ul style="list-style-type: none"> <li>• 1:1 communication (Monitor, program up/download)</li> <li>• Dedicated link instruction</li> </ul>		△	For comparison of dedicated link instruction, refer to Section 5.1.7.	

- \*1 Remote master station → remote sub-master station, remote I/O station: 8192 points  
Remote sub-master station, remote I/O station → remote master station: 8192 points
- \*2 The remote master station includes the multiplexed remote master station and multiplexed remote sub-master station.
- \*3 When the X/Y numbers are duplicate, one side only is taken into consideration.
- \*4 For the A1SJ72QLP25, the maximum number of I/O points per remote I/O station is " $X + Y \leq 1024$  points".
- \*5 For the multiplexed remote I/O network, one station in 64 stations of the remote I/O station is used for the multiplexed remote sub-master station.



## 2) Comparison of AJ72LP25G/AJ72QLP25G and QJ72LP25G

○ : Compatible, △: Partial change required, × : Incompatible

Item	Specifications			Compatibility	Precautions for replacement
	AJ72LP25	AJ72QLP25G	QJ72LP25G		
Maximum number of link points per network	LX/LY	8192 points		○	
	LB	8192 points	16384 points* <sup>1</sup>	○	
	LW	8192 points	16384 points* <sup>1</sup>	○	
Maximum number of link points per station	<Remote master station → remote I/O station> * <sup>2</sup> $\{(LY + LB) \div 8 + (2 \times LW)\} \leq 1600$ bytes <Remote I/O station → remote master station> * <sup>2</sup> $\{(LY + LB) \div 8 + (2 \times LW)\} \leq 1600$ bytes			○	
Maximum number of I/O points per remote I/O station	$X + Y \leq 2048$ points		$X + Y \leq 4096$ points* <sup>3</sup>	△	
Communication speed	10Mbps			○	
Communication method	Token ring method			○	
Synchronous type	Frame synchronization method			○	
Encoding method	NRZI coding (Non Return to Zero Inverted)			○	
Transmission method	Duplex loop			○	
Transmission format	HDLC standards (frame format)			○	
Maximum number of networks	255 (Total number of PLC to PLC networks and remote I/O networks)	239 (Total number of PLC to PLC networks and remote I/O networks)		△	Network No.240 to No.250 cannot be set. Alternate them with unused network No.
Number of stations connected in one network	65 stations (Remote master station: 1, remote I/O station: 64)* <sup>4</sup>			○	
Applicable cable	GI optical cable			○	
Overall distance	30km			○	
Distance between stations	GI optical cable: 2km			○	
Error control system	CRC ( $X^{16}+X^{12}+X^5+1$ ) and retry by a time over			○	
RAS function	<ul style="list-style-type: none"> <li>• Loop-back function due to error detection or broken cable</li> <li>• Diagnostic function for checking local link lines</li> <li>• Abnormal detection using link special relays and link special registers</li> <li>• Network monitoring and various diagnostic functions</li> </ul>			○	
Transient transmission	<ul style="list-style-type: none"> <li>• Monitor, program up/download with peripheral device</li> <li>• Dedicated link instruction</li> <li>• Available for Intelligent function module (only AJ72QLP25G)</li> </ul>	<ul style="list-style-type: none"> <li>• 1:1 communication (Monitor, program up/download)</li> <li>• Dedicated link instruction</li> </ul>		△	For comparison of dedicated link instruction, refer to Section 5.1.7.

\*1 Remote master station → remote sub-master station, remote I/O station: 8192 points

Remote sub-master station, remote I/O station → remote master station: 8192 points

\*2 The remote master station includes the multiplexed remote master station and multiplexed remote sub-master station.

\*3 When the X/Y numbers are duplicate, one side only is taken into consideration.

\*4 For the multiplexed remote I/O network, one station in 64 stations of the remote I/O station is used for the multiplexed remote sub-master station.

## 3) Comparison of AJ72LR25/AJ72QLR25/A1SJ72QLR25 and QJ72BR15

○ : Compatible, △ : Partial change required, × : Incompatible

Item	Specifications			Compatibility	Precautions for replacement
	AJ72LR25	AJ72QLR25 A1SJ72QLR25	QJ72BR15		
Maximum number of link points per network	LX/LY	8192 points		○	
	LB	8192 points	16384 points* <sup>1</sup>	○	
	LW	8192 points	16384 points* <sup>1</sup>	○	
Maximum number of link points per station	<Remote master station → remote I/O station>* <sup>2</sup> $\{(LY + LB) \div 8 + (2 \times LW)\} \leq 1600$ bytes <Remote I/O station → remote master station>* <sup>2</sup> $\{(LY + LB) \div 8 + (2 \times LW)\} \leq 1600$ bytes			○	
Maximum number of I/O points per remote I/O station	$X + Y \leq 2048$ points	$X + Y \leq 2048$ points* <sup>4</sup>	$X + Y \leq 4096$ points* <sup>3</sup>	△	
Communication speed	10Mbps			○	
Communication method	Token ring method		Token bus method	△	Nothing to be noted though the communication method differs.
Synchronous type	Frame synchronization method			○	
Encoding method	Manchester code			○	
Transmission method	Duplex loop		Single bus	△	The loopback function and multiplex transmission function cannot be used on a coaxial bus system. To use the functions, using an optical loop system is recommended.
Transmission format	HDLC standards (frame format)			○	
Maximum number of networks	255 (Total number of PLC to PLC networks and remote I/O networks)	239 (Total number of PLC to PLC networks and remote I/O networks)		△	Network No.240 to No.250 cannot be set. Alternate them with unused network No.
Number of stations connected in one network	65 stations (Remote master station: 1, remote I/O station: 64)* <sup>5</sup>		33 stations (Remote master station: 1, remote I/O station: 32)* <sup>6</sup>	△	Remote I/O stations up to 32 stations can be used on a coaxial bus system. To use 33 remote I/O stations or more, using an optical loop system is recommended.
Applicable cable	3C-2V, 5C-2V, 5C-FB			○	
Overall distance	3C-2V: 19.2km 5C-2V, 5C-FB: 30km		3C-2V: 300m 5C-2V, 5C-FB: 500m	△	Either use an A6BR10/A6BR10-DC type repeater unit, or use an optical loop system.
Distance between stations	3C-2V: 300m 5C-2V, 5C-FB: 500m			○	
Error control system	CRC( $X^{16} + X^{12} + X^5 + 1$ ) and retry by a time over			○	
RAS function	<ul style="list-style-type: none"> <li>Loop-back function due to error detection or broken cable</li> <li>Diagnostic function for checking local link lines</li> <li>Abnormal detection using link special relays and link special registers</li> <li>Network monitoring and various diagnostic functions</li> </ul>		<ul style="list-style-type: none"> <li>Diagnostic function for checking local link lines</li> <li>Abnormal detection using link special relays and link special registers</li> <li>Network monitoring and various diagnostic functions</li> </ul>	△	The loopback function cannot be used on a coaxial bus system. To use the loopback function, using an optical loop system is recommended.
Transient transmission	<ul style="list-style-type: none"> <li>Monitor, program up/download with peripheral device</li> <li>Dedicated link instruction</li> </ul>		<ul style="list-style-type: none"> <li>1:1 communication (Monitor, program up/download)</li> <li>Dedicated link instruction</li> </ul>	△	For comparison of dedicated link instruction, refer to Section 5.1.7.

\*1 Remote master station → remote sub-master station, remote I/O station: 8192 points

Remote sub-master station, remote I/O station → remote master station: 8192 points

\*2 The remote master station includes the multiplexed remote master station and multiplexed remote sub-master station.

\*3 When the X/Y numbers are duplicate, one side only is taken into consideration.

\*4 For the A1SJ72QLP25, the maximum number of I/O points per remote I/O station is "X + Y ≤ 1024 points".

\*5 For the multiplexed remote I/O network, one station in 64 stations of the remote I/O station is used for the multiplexed remote sub-master station.

\*6 For the multiplexed remote I/O network, one station in 32 stations of the remote I/O station is used for the multiplexed remote sub-master station.

## 4) Comparison of AJ72BR15/AJ72QBR15/A1SJ72QBR15 and QJ72BR15

○ : Compatible, △ : Partial change required, × : Incompatible

Item	Specifications			Compatibility	Precautions for replacement
	AJ72BR15	AJ72QBR15 A1SJ72QBR15	QJ72BR15		
Maximum number of link points per network	LX/LY	8192 points		○	
	LB	8192 points	16384 points*1	○	
	LW	8192 points	16384 points*1	○	
Maximum number of link points per station		<Remote master station → remote I/O station>*2 {(LY + LB) ÷ 8 + (2 × LW)} ≤ 1600 bytes <Remote I/O station → remote master station>*2 {(LY + LB) ÷ 8 + (2 × LW)} ≤ 1600 bytes		○	
Maximum number of I/O points per remote I/O station		X + Y ≤ 2048 points	X + Y ≤ 2048 points*4	X + Y ≤ 4096 points*3	△
Communication speed		10Mbps		○	
Communication method		Token bus method		○	
Synchronous type		Frame synchronization method		○	
Encoding method		Manchester code		○	
Transmission method		Single bus		○	
Transmission format		HDLC standards (frame format)		○	
Maximum number of networks		255 (Total number of PLC to PLC networks and remote I/O networks)	239 (Total number of PLC to PLC networks and remote I/O networks)	△	Network No.240 to No.250 cannot be set. Alternate them with unused network No.
Number of stations connected in one network		33 stations (Remote master station: 1, remote I/O station: 32)*5		○	
Applicable cable		3C-2V, 5C-2V, 5C-FB		○	
Overall distance		3C-2V: 300m 5C-2V, 5C-FB: 500m		○	
Distance between stations		3C-2V: 300m 5C-2V, 5C-FB: 500m		○	
Error control system		CRC (X <sup>16</sup> +X <sup>12</sup> +X <sup>5</sup> +1) and retry by a time over		○	
RAS function		<ul style="list-style-type: none"> <li>• Loop-back function due to error detection or broken cable</li> <li>• Diagnostic function for checking local link lines</li> <li>• Abnormal detection using link special relays and link special registers</li> <li>• Network monitoring and various diagnostic functions</li> </ul>		○	
Transient transmission		<ul style="list-style-type: none"> <li>• Monitor, program up/download with peripheral device</li> <li>• Dedicated link instruction</li> <li>• Available for Intelligent function module (only AJ71QBR15/A1SJ72QBR15)</li> </ul>	<ul style="list-style-type: none"> <li>• 1:1 communication (Monitor, program up/download)</li> <li>• Dedicated link instruction</li> </ul>	△	For comparison of dedicated link instruction, refer to Section 5.1.7.

\*1 Remote master station → remote sub-master station, remote I/O station: 8192 points  
Remote sub-master station, remote I/O station → remote master station: 8192 points

\*2 The remote master station includes the multiplexed remote master station and multiplexed remote sub-master station.

\*3 When the X/Y numbers are duplicate, one side only is taken into consideration.

\*4 For the A1SJ72QBR15, the maximum number of I/O points per remote I/O station is "X + Y ≤ 1024 points".

\*5 For the multiplexed remote I/O network, one station in 32 stations of the remote I/O station is used for the multiplexed remote sub-master station.

**(2) Cable performance comparisons****(a) Optical fiber cable****1) Overall distance**

The overall distance (30km) does not differ according to the optical fiber cable.

**2) Distance between stations**

- SI optical fiber cable

○ : Compatible, △ : Partial change required, × : Incompatible

Type	Specifications			Compat- ibility	Precautions for replacement	
	A/AnS/QnA/QnAS series MELSECNET/10 module (optical loop)		Q series MELSECNET/H module (optical loop)			
			10Mbps			25Mbps
SI optical fiber cable	500m		500m	200m	△	Refer to <sup>*1</sup> below.
H-PCF optical fiber cable	1km		1km	400m	△	Refer to <sup>*1</sup> below.
Broad-band H-PCF optical fiber cable	1km		1km		○	

\*1 When the distance between stations do not satisfy with specifications of MELSECNET/H, use at 10 Mbps of communication speed, change the type of optical fiber cable or set the gateway station on the existing cable.

- GI optical fiber cable

○ : Compatible, △ : Partial change required, × : Incompatible

Type	Specifications		Compat- ibility	Precautions for replacement
	A/AnS/QnA/QnAS series MELSECNET/10 module (optical loop)	Q series MELSECNET/H module (optical loop)		
GI optical fiber cable	2km	2km	○	

**(3) Coaxial cable****(a) Overall distance**

○ : Compatible, △ : Partial change required, × : Incompatible

Type	Specifications			Compat- ibility	Precautions for replacement
	A/AnS/QnA/QnAS series MELSECNET/10 module		Q series MELSECNET/H module		
	Coaxial bus	Coaxial loop	(Coaxial bus)		
3C-2V	300m	19.2km	300m	△	Refer to <sup>*1</sup> below.
5C-2V	500m	30km	500m	△	Refer to <sup>*1</sup> below.
5C-FB	500m	30km	500m	△	Refer to <sup>*1</sup> below.

\*1 When the overall distance does not satisfy the MELSECNET/H specifications, either use an A6BR10/A6BR10-DC type repeater unit in the network, or configure a separate network.

**(b) Distance between stations**

○ : Compatible, △ : Partial change required, × : Incompatible

Type	Specifications			Compat- ibility	Precautions for replacement
	A/AnS/QnA/QnAS series MELSECNET/10 module		Q series MELSECNET/H module		
	Coaxial bus	Coaxial loop	(Coaxial bus)		
3C-2V	300m	300m	300m	○	
5C-2V	500m	500m	500m	○	
5C-FB	500m	500m	500m	○	

Remarks

The following shows the extension method when a repeater unit for the A6BR10/A6BR10-DC type MELSECNET/10 coaxial bus system is used.

For details, refer to the Repeater Unit for the MELSECNET/10 Coaxial Bus System type A6BR10/A6BR10-DC User's Manual (IB-66499).

- (1) The distance between stations of 500m (5C-2V) and 300m (3C-2V) can be extended.

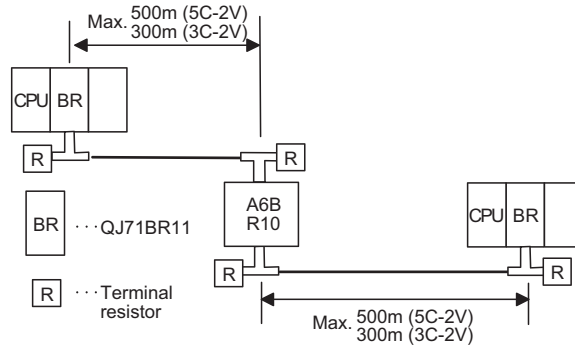

- (2) Up to four repeater units can be used in a single network.\*2

The overall distance can be extended to a maximum distance of 2.5 km.

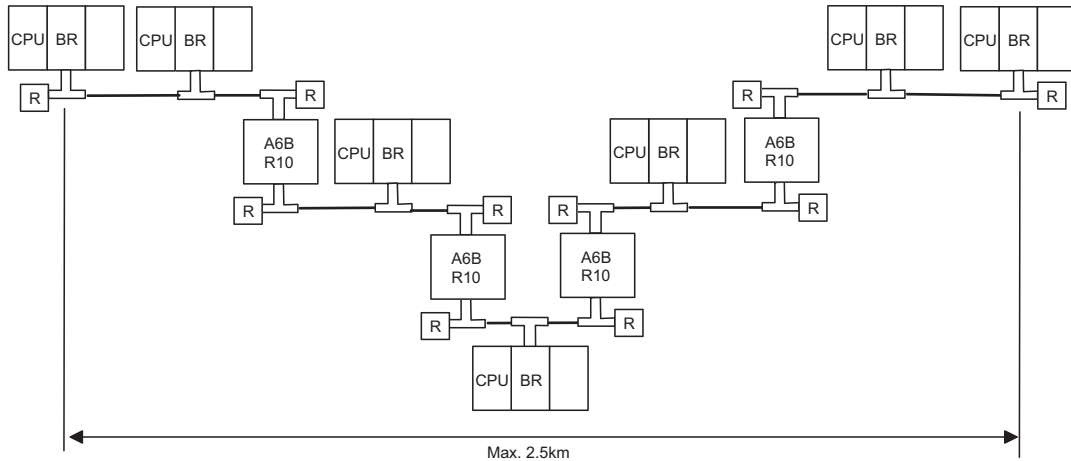

\*2 It is necessary to add terminal resistor A6RCON-R75 (sold separately).

### 5.1.3 Functional Comparisons

#### (1) A/AnS series

○ : Compatible, △ : Partial change required, × : Incompatible

Item	Description		Compat- ibility	Precautions for replacement
	A/AnS series MELSECNET/10 module <sup>*1</sup>	Q series MELSECNET/H module <sup>*2</sup>		
Cyclic transfer function	Communicating with I/O module	Performs communications with the I/O module of the remote I/O station using X/Y (LX/LY).	○	
	Communicating with special function module	Performs communications with the special function module of the remote I/O station using X/Y (LX/LY) and B/W (LB/LW).	○	
	Data link stop/restart function	Stops cyclic transmission temporarily with GX Works2 or GX Developer.	○	
Transient transmission function	N:N communication function	Communicates only when communication requests are issued between each stations. (Communication using dedicated link instruction and GX Works2/GX Developer.)	△	ZNFR instruction and ZNTO instruction cannot be used. Change them to REMFR instruction and REMTO instruction.
	Routing function	Performs transient transmission to other stations of which network No. are different.	○	
Reserved station function		Treats the stations, which are to be connected in the future, as reserved stations. By specifying the stations, which are not connected, as reserved stations, communication error does not occur.	○	
I/O assignment function		Sets the module configuration of the remote I/O station.	△	Set the function with the PLC parameter of the remote I/O module.
Extension functions	Constant link scan function	Keeps link scan time constant.	○	
	Multiplex transmission function	Performs high-speed communication using duplex transmission path (forward loop/reverse loop).	○	
	Return sequence station number setting function	Sets the number of stations that can return to system during one link scan.	○	
	ZNFR/ZNTO instruction access number setting function	Sets the number of transient transmissions (a total of entire one network) that can be executed during one link scan.	△	The number of transient transmissions differs depending on the total number of normal stations. The number of transient transmissions per normal station is equal.

\*1 Use GX Developer.

\*2 Use GX Works2 or GX Developer.

(To next page)

○ : Compatible, △ : Partial change required, × : Incompatible

Item	Description		Compat- ibility	Precautions for replacement
	A/AnS series MELSECNET/10 module	Q series MELSECNET/H module		
RAS function	Automatic return function	Returns the station disconnected from data link to the system when it goes to normal status and restarts data link.	○	
	Loopback function	Keeps normal operation between operable stations by disconnecting faulty area at error occurrence such as cable break.	○	
	Station detach function	Keeps normal operation between operable stations except faulty stations and stations switched off.	○	
	Diagnostic function	Checks line conditions of the network and setting conditions of the module.	△	<ul style="list-style-type: none"> <li>Substitute the forward loop/reverse loop test for the station-to-station test.</li> <li>Set diagnostic items for station-to-station test and forward loop/reverse loop test in GX Works2 or GX Developer network parameters.</li> </ul>
	Blown fuse error and input/output verification error check disabled function	Sets the error check of the blown fuse error and the input/output verification error.	△	Set the function with the PLC parameter of the remote I/O module.

**(2) Comparison with QnA/QnAS series**

○ : Compatible, △ : Partial change required, × : Incompatible

Item	Description		Compat- ibility	Precautions for replacement
	QnA/QnAS series MELSECNET/10 module*1	Q series MELSECNET/H module*2		
Cyclic transfer function	Communicating with I/O module	Performs communications with the I/O module of the remote I/O station using X/Y (LX/LY).	○	
	Communicating with special function module	Performs communications with the special function module of the remote I/O station using X/Y (LX/LY) and B/W (LB/LW).	○	
	Cyclic transmission stop/restart	Stops cyclic transmission temporarily with GX Works2 or GX Developer.	○	
	Direct access to the link devices	Reads/writes directly from/to link device of the network module on the sequence program.	○	
	Default of network refresh parameter	Eliminates the refresh parameters setting by using default values of refresh parameters.	○	

(To next page)

○ : Compatible, △ : Partial change required, × : Incompatible

Item	Description		Compat- ibility	Precautions for replacement
	QnA/QnAS series MELSECNET/10 module*1	Q series MELSECNET/H module*2		
Transient transmission function	Transient transmission function	Communicates only when communication requests are issued between each stations. (Communication using dedicated link instruction and GX Works2/GX Developer.)	○	
	Routing function	Performs transient transmission to other stations of which network No. are different.	○	
	Dedicated link instruction	Performs communications with other station at desired timing using dedicated link instruction.	△	ZNFR instruction and ZNTO instruction cannot be used. Change them to REMFR instruction and REMTO instruction.
	Specification of default network	Processes the requests that cannot specify network No. of access path.	○	
	Clock setup for stations on network with peripheral device	Performs clock setup to CPU modules connected to the network with GX Works2 or GX Developer.	○	
Multiplex transmission function	Performs high-speed communication using duplex transmission path (forward loop/reverse loop).	○		
Reserved station function	Treats the stations, which are to be connected in the future, as reserved stations. By specifying the stations, which are not connected, as reserved stations, communication error does not occur.	○		
Multiplex master system	Allows the remote sub-master station to automatically control the remote I/O stations in the case of the multiplexed remote master station failure.	△	<ul style="list-style-type: none"> <li>The function is available only when mounted on Q12PH/Q25PH/Q12PRH/Q25PRH CPU.</li> <li>The multiplexed remote master station and the multiplexed remote sub-master station cannot be mounted on the same programmable controller CPU. Mount on separate programmable controller CPU.</li> </ul>	
Parallel master system	Sets two remote master stations in the same network.	△	Cannot be configured on the remote I/O network of MELSECNET/H. Configure two networks.	
Settings of remote I/O station output status in the case of system failure with programmable controller CPU error	Retains the output status of the remote I/O station in the case of the remote master station error.	△	Set the function with the PLC parameter of the remote I/O module.	



Item	Description		Compat- ibility	Precautions for replacement
	QnA/QnAS series MELSECNET/10 module* <sup>1</sup>	Q series MELSECNET/H module* <sup>2</sup>		
RAS function	Automatic return function	Returns the station disconnected from data link to the system when it goes to normal status and restarts data link.	○	
	Loopback function	Keeps normal operation between operable stations by disconnecting faulty area at error occurrence such as cable break.	○	
	Station detach function	Keeps normal operation between operable stations except faulty stations and stations switched off.	○	
	Transient transmission available even if programmable controller CPU is in error	Checks the errors for CPU modules of which a stop error occurs, via network from GX Works2 or GX Developer.	○	
	Checking the transient transmission abnormal detection time	Checks error completion time, abnormal detection network number and abnormal detection station number of transient transmission.	○	
	Diagnostic function	Checks line conditions of the network and setting conditions of the module.	△	<ul style="list-style-type: none"> <li>• Substitute the forward loop/reverse loop test for the station-to-station test.</li> <li>• Set diagnostic items for station-to-station test and forward loop/reverse loop test in GX Works2 or GX Developer network parameters.</li> </ul>
	Blown fuse error and input/output verification error check disabled function	Sets the error check of the blown fuse error and the input/output verification error.	△	Set the function with the PLC parameter of the remote I/O module.

\*1 Use GX Developer.

\*2 Use GX Works2 or GX Developer.

## 5.1.4 Switch setting comparisons

### (1) Switch settings comparisons of remote master station

○ : Compatible, △ : Partial change required, × : Incompatible

Switch name	Description		Compat- ibility	Precautions for replacement
	A/AnS/QnA/QnAS series MELSECNET/10 module	Q series MELSECNET/H module		
Network No. setting switch	Sets the network No.	-	△	<ul style="list-style-type: none"> <li>Set in GX Works2 or GX Developer network parameters.</li> <li>Network No.240 to No.255 cannot be set. Alternate them with unused network Nos.</li> </ul>
Mode setting switch	Sets the mode. <Setting range> 0: Online 2: Offline 3: Loop test (forward loop) 4: Loop test (reverse loop) 5: Station-to-station test (master station) 6: Station-to-station test (normal station) 7: Self-loopback test 8: Internal self-loopback test 9: H/W test D: Network No. check E: Group No. check <sup>*1</sup> F: Station No. check	[Using QJ71LP21-25 and QJ71LP21S-25] Sets the mode. <Setting range> 0: Online (10Mbps) 1: Self-loopback test (10Mbps) 2: Internal self-loopback test (10Mbps) 3: Hardware test (10Mbps) 4: Online (25Mbps) 5: Self-loopback test (25Mbps) 6: Internal self-loopback test (25Mbps) 7: Hardware test (25Mbps) [Using QJ71LP21G and QJ71BR11] Sets the mode. <Setting range> 0: Online 1: Self-loopback test 2: Internal self-loopback test 3: Hardware test	△	<ul style="list-style-type: none"> <li>Set offline and loop test in GX Works2 or GX Developer network parameters.</li> <li>Substitute the forward loop/reverse loop test for the station-to-station test.</li> <li>Check network No., group No. and station No. in GX Works2 or GX Developer network diagnostics (host information).</li> </ul>
Condition setting switch	Sets the operation conditions.	-	△	Set in GX Works2 or GX Developer network parameters.

\*1 Group No. check is not used on the remote I/O network.

## (2) Remote I/O station switch settings comparisons

○ : Compatible, △: Partial change required, × : Incompatible

Switch name	Description		Compat- ibility	Precautions for replacement
	A/AnS/QnA/QnAS series MELSECNET/10 module	Q series MELSECNET/H module		
Mode setting switch	Sets the mode. <Setting range> 0: Online 2: Offline 3: Loop test (forward loop) 4: Loop test (reverse loop) 5: Station-to-station test (master station) 6: Station-to-station test (normal station) 7: Self-loopback test 8: Internal self-loopback test 9: H/W test F: Station No. check	[Using QJ72LP25-25] Sets the mode. <Setting range> 0: Online (10Mbps) 1: Self-loopback test (10Mbps) 2: Internal self-loopback test (10Mbps) 3: Hardware test (10Mbps) 4: Online (25Mbps) 5: Self-loopback test (25Mbps) 6: Internal self-loopback test (25Mbps) 7: Hardware test (25Mbps) 8: Online (MELSECNET/10 mode)*1 [Using QJ72LP25G and QJ72BR15] Sets the mode. <Setting range> 0: Online 1: Self-loopback test 2: Internal self-loopback test 3: Hardware test 8: Online (MELSECNET/10 mode)*1	△	<ul style="list-style-type: none"> <li>• Set offline and loop test in GX Works2 or GX Developer network parameters.</li> <li>• Substitute the forward loop/reverse loop test for the station-to-station test.</li> <li>• Check network No., group No. and station No. in GX Works2 or GX Developer network diagnostics (host information).</li> </ul>
Condition setting switch	Sets the operation conditions.	-	△	Nothing to be noted for the MELSECNET/H.

\*1 Modules with a serial number (first five digits) of "15012" or later supports Online (MELSECNET/10 mode).

## 5.1.5 Parameter comparisons

## (1) Parameter of remote master station

○ : Compatible, △ : Partial change required, × : Incompatible

Parameter name	Description		Compat- ibility	Precautions for replacement	
	A/AnS/QnA/QnAS series MELSECNET/10 module	Q series MELSECNET/H module			
Network parameter	Network type		○		
	Starting I/O No.		○		
	Network No.		○		
	Total number of (normal) stations		○		
	-		△	Set the mode in GX Works2 or GX Developer network parameters.	
	Network range assignment (common parameter)	Monitoring time	Monitoring time	○	
		BW setting	BW setting	○	
		XY setting	XY setting	○	
		Reserved station designation	Reserved station designation	○	
		I/O assignment setting	-	△	Set with the PLC parameter of each remote I/O station.
		Supplemental settings	Supplemental settings	○	
	Refresh parameters		Refresh parameters	○	
	Routing parameters		Routing parameters	○	
	Valid module during other station access		Valid module during other station access	○	

## (2) Parameter of multiplexed remote master station\*1

○ : Compatible, △: Partial change required, × : Incompatible

Parameter name	Description		Compat- ibility	Precautions for replacement	
	QnA/QnAS series MELSECNET/10 module	Q series MELSECNET/H module			
Network parameter	Network type		○		
	Starting I/O No.		○		
	Network No.		○		
	Total number of (normal) stations		○		
	-		Group No.	△	The group No. is not used in the remote I/O network. Set to [0].
	-		Mode	△	Set the mode in GX Works2 or GX Developer network parameters.
	Network range assignment (common parameter)	Monitoring time	Monitoring time	○	
		BW setting	BW setting	○	
		XY setting	XY setting	○	
		Reserved station designation	Reserved station designation	○	
		Remote sub-master station specification	Remote sub-master station specification	○	
		I/O assignment setting	-	△	Set with the PLC parameter of each remote I/O station.
		Supplemental settings	Supplemental settings	○	
	Refresh parameters		Refresh parameters	○	
Routing parameters		Routing parameters	○		

\*1 The multiplexed remote master station is the station type of the multiplex master system.  
Only the following CPU modules support the multiplex master system.

- Process CPU
- Redundant CPU

## (3) Parameter of multiplexed remote sub-master station \*1

○ : Compatible, △: Partial change required, × : Incompatible

Parameter name	Description		Compat- ibility	Precautions for replacement	
	QnA/QnAS series MELSECNET/10 module	Q series MELSECNET/H module			
Network parameter	Network type	Network type	○		
	Starting I/O No.	Starting I/O No.	○		
	Network No.	Network No.	○		
	-	Total number of (normal) stations	△	New parameter of MELSECNET/H (To enable the multiplexed remote sub-master station to control the remote I/O station, the setting is required.)	
	-	Group No.	△	The group No. is not used in the remote I/O network. Set to [0].	
	-	Mode	△	Set the mode in GX Works2 or GX Developer network parameters.	
	-	Network range assignment (common parameter)	Monitoring time	△	New parameter of MELSECNET/H (To enable the multiplexed remote sub-master station to control the remote I/O station, the setting is required.)
			BW setting	△	
			XY setting	△	
			Reserved station designation	△	
			Remote sub-master station specification	△	
			Supplemental settings	△	
	Refresh parameters	Refresh parameters	○		
Routing parameters	Routing parameters	○			
Valid module during other station access	Valid module during other station access	○			

\*1 The multiplexed remote sub-master station is the station type of the multiplex master system.

Only the following CPU modules support the multiplex master system.

- Process CPU
- Redundant CPU

## (4) Parameter of parallel remote master station

○ : Compatible, △ : Partial change required, × : Incompatible

Parameter name	Description		Compat- ibility	Precautions for replacement	
	QnA/QnAS series MELSECNET/10 module	Q series MELSECNET/H module			
Network parameter	Network type		△	Cannot be configured on the remote I/O network of MELSECNET/H. Configure two networks.	
	Starting I/O No.		△		
	Network No.		△		
	Total number of (normal) stations		△		
		Monitoring time			△
		BW setting			△
		XY setting			△
		Sub-BW setting			△
		Sub-XY setting			△
		Remote sub- master station specification	-		△
	Network range assignment (common parameter)	Reserved station designation			△
		I/O assignment setting			△
		Supplemental settings			△
		Refresh parameters			△
	Routing parameters				△
	Valid module during other station access				△

## (5) Parameter of parallel remote sub-master station

○ : Compatible, △ : Partial change required, × : Incompatible

Parameter name	Description		Compat- ibility	Precautions for replacement
	QnA/QnAS series MELSECNET/10 module	Q series MELSECNET/H module		
Network parameter	Network type	-	△	Cannot be configured on the remote I/O network of MELSECNET/H. Configure two networks.
	Starting I/O No.		△	
	Network No.		△	
	Refresh parameters		△	
	Routing parameters		△	
	Valid module during other station access		△	

## (6) Parameter of remote I/O station

When mounting the intelligent function module on the remote I/O station, set the parameter.

When mounting only I/O modules, the operation is available even if the parameter is not set. (It is operated with default value.)

○ : Compatible, △ : Partial change required, × : Incompatible

Parameter name	Description		Compat- ibility	Precautions for replacement
	A/AnS/QnA/QnAS series MELSECNET/10 module	Q series MELSECNET/H module		
PLC parameters	-	PLC system setting	△	New parameter of MELSECNET/H (The number of empty slots, etc. is set.)
	-	PLC RAS setting	△	New parameter of MELSECNET/H (The operation mode and error check at an error are set.)
	-	Operation setting	△	New parameter of MELSECNET/H (The parameters for transmitting between devices are set.)
	-	I/O assignment setting	△	New parameter of MELSECNET/H (The I/O assignment of remote I/O station, etc. is set.)
Network parameter	-	Ethernet	△	New parameter of MELSECNET/H (The network parameter of Ethernet module mounted on the remote I/O station is set.)
		CC-Link	△	New parameter of MELSECNET/H (The network parameter of CC- Link module mounted on the remote I/O station is set.)
Remote password	-	Remote password setting	△	New parameter of MELSECNET/H (The remote password of Ethernet module and serial communication module, etc. mounted on the remote I/O station is set.)



### 5.1.6 Program comparisons

#### (1) Comparison of link special relay (SB)/link special register (SW)

The table below shows only link special relay (SB) and link special register (SW) to be used in interlock program.

The following device name and device No. are described in link device of internal MELSECNET/10 or MELSECNET/H module.

Changing sequence program should be performed after checking the refreshed device of link device in refresh parameters.

##### (a) Link special relay (SB)

○ : Compatible, △: Partial change required, × : Incompatible

Item	Number		Compat- ibility	Precautions for replacement
	A/AnS/QnA/QnAS series MELSECNET/10 module	Q series MELSECNET/H module		
Module status	SB0020	SB0020	○	
Baton pass status (host)	SB0047	SB0047	○	
Data link status of each station	SB0049	SB0049	○	
Baton pass status of each station	SB0070	SB0070	○	
Cyclic transmission status of each station	SB0074	SB0074	○	

##### (b) Link special register (SW)

○ : Compatible, △: Partial change required, × : Incompatible

Item	Number		Compat- ibility	Precautions for replacement
	A/AnS/QnA/QnAS series MELSECNET/10 module	Q series MELSECNET/H module		
Baton pass status of each station	SW0070 to SW0073	SW0070 to SW0073	○	
Cyclic transmission status of each station	SW0074 to SW0077	SW0074 to SW0077	○	

#### Remarks

For link special relay (SB) and link special register (SW) that are not described in this section, refer to each manual.

## 5.1.7 Comparison of dedicated instruction

### (1) A/AnS series

○ : Compatible, △ : Partial change required, × : Incompatible

Instruction name	Description		Compat- ibility	Precautions for replacement
	A/AnS series MELSECNET/10 module	Q series MELSECNET/H module		
ZNFR instruction	Reads data from the buffer memory of special function module in the target remote I/O station.	Reads data from the buffer memory of the intelligent function module in the target remote I/O station.	△	ZNFR instruction cannot be used. Change it to REMFR instruction.
ZNTO instruction	Writes data to the buffer memory of special function module in the target remote I/O station.	Writes data to the buffer memory of the intelligent function module in the target remote I/O station.	△	ZNTO instruction cannot be used. Change it to REMFR instruction.

### (2) QnA/QnAS series

○ : Compatible, △ : Partial change required, × : Incompatible

Instruction name	Description		Compat- ibility	Precautions for replacement
	QnA/QnAS series MELSECNET/10 module	Q series MELSECNET/H module		
ZNFR instruction	Reads data from the buffer memory of special function module in the target remote I/O station.	Reads data from the buffer memory of the intelligent function module in the target remote I/O station.	△	ZNFR instruction cannot be used. Change it to REMFR instruction.
ZNTO instruction	Writes data to the buffer memory of special function module in the target remote I/O station.	Writes data to the buffer memory of the intelligent function module in the target remote I/O station.	△	ZNTO instruction cannot be used. Change it to REMFR instruction.
SEND instruction	Sends data to target station.		○	
RECV instruction	Reads data sent by SEND instruction to device of CPU module.		○	
READ instruction, SREAD instruction	Reads the device data of other station.		○	
WRITE instruction, SWRITE instruction	Writes data to the device of other station.		○	
REQ instruction	Issues "remote RUN/STOP" and "clock data read/write" requests to other stations.		○	
ZNRD instruction	Reads the device data of other station.		○	
ZNWR instruction	Writes data to the device of other station.		○	

(3) Q series dedicated link instruction list

The table below shows the dedicated link instructions usable in Q series.

For instruction format of dedicated link instruction and precautions, refer to the following manual.

- Q corresponding MELSECNET/H Network System Reference Manual (Remote I/O network)
- Q corresponding MELSECNET/H Network System Reference Manual (PLC to PLC network)

(a) For remote I/O station

○ : Can be used, × : Cannot be used

Instruction	Name	Execution station	Description	Target station
		QCPU		Remote I/O module
REMFR	Read remote I/O station intelligent function module buffer memory	○	<p>Reads data from the remote I/O station intelligent function module buffer memory.</p>	○
REMTO	Write remote I/O station intelligent function module buffer memory	○	<p>Writes data to object remote I/O station intelligent function module buffer memory. (Not processed at the execution from multiplexed remote sub-master station.)</p>	○
READ	Read other station word device	○	<p>Reads remote I/O station device data for object network number. (in 16-bit units)</p>	○
WRITE	Write other station word device	○	<p>Writes device to object network number remote I/O station. (in 16-bit units)</p>	○

(b) For multiplexed remote master station and multiplexed remote sub-master station

○ : Can be used, × : Cannot be used

Instruction	Name	Execution station		Description	Target station	
		QnPH CPU	QnPRH CPU		Multiplexed remote master station	Multiplexed remote sub-master station
SEND	Data sending	○	×	SEND:Writes data to the target station (network module) of the target network No. RECV:Reads the data sent by SEND to the CPU device.	○	○
RECV	Data receiving	○	×		○	○
READ SREAD	Other station word device read	○	○	<p>Reads the CPU device data of the target station of the target network No. (in 16-bit units).</p>	○	○
WRITE SWRITE	Other station word device write	○	○	<p>Writes data to the CPU device of the target station of the target network No. (in 16-bit units). (SWRITE can turn ON the device of the target station.)</p>	○	○
REQ	Requesting transient transmission to other stations	○	○	<p>Issues "remote RUN" and "clock data read/write" requests to other stations.</p>	○	○

(To next page)

○ : Can be used, × : Cannot be used

Instruction	Name	Execution station		Description	Target station	
		QnPH CPU	QnPRH CPU		Multiplexed remote master station	Multiplexed remote sub-master station
RECVS	Receive message (completed in 1 scan)	○	×	<p>Receives the channel data, which was sent by SEND, within an interrupt program and reads that data to the CPU device immediately. Processing is completed when the instruction is executed.</p>	○	○
ZNRD	Other station word device read	○	○	<p>[A-compatible instruction] Reads the CPU device data of the target station of the target network No.</p>	○	○
ZNWR	Other station word device write	○	○	<p>[A-compatible instruction] Writes data to the CPU device of the target station of the target network No.</p>	○	○
RRUN	Remote RUN	○	○	<p>Performs "remote RUN" to the CPU module of the other station.</p>	○	○

(To next page)

○ : Can be used, x : Cannot be used

Instruction	Name	Execution station		Description	Target station	
		QnPH CPU	QnPRH CPU		Multiplexed remote master station	Multiplexed remote sub-master station
RSTOP	Remote STOP	○	○	<p>Performs "remote STOP" to the CPU module of the other station.</p>	○	○
RTMRD	Other station clock data read	○	○	<p>Performs "clock data read" to the CPU module of the other station.</p>	○	○
RTMWR	Other station clock data written	○	○	<p>"Write clock data" to the CPU module of other station.</p>	○	○

### 5.1.8 Other precautions

#### (1) Remote I/O network replacement precautions

Replace all remote I/O stations with Q series MELSECNET/H modules when the CPU module on the remote master station is replaced with a Q series CPU module

On the MELSECNET/H remote I/O network, the A/AnS/QnA/QnAS series MELSECNET/10 module and the Q series MELSECNET/H module cannot be used in combination.

For the method of replacing some remote I/O stations with a Q series module without changing the remote master station using the A/AnS/QnA/QnAS series, refer to Section 5.2.

#### (2) Processing time

The link scan time and link refresh time differ between the A/AnS/QnA/QnAS series and the Q series. For details on processing time, refer to the manual for the respective module.

#### (3) Interface of remote I/O station

The interface to connect programming tools such as GX Works2 or GX Developer differs between the A/AnS/QnA/QnAS series and the Q series.

- A/AnS/QnA/QnAS series:RS-422 interface
- Q series:RS-232 interface

When connecting to the Q series, use the following RS-232 cable.

- RS-232 cable: QC30R2

#### (4) Precautions for replacement of QnA/QnAS series

##### (a) Parallel master system

The parallel master system cannot be configured in the MELSECNET/H. Configure two networks.

MELSECNET/10	MELSECNET/H	System configuration precautions
<p>           ■PM<sub>R</sub> Parallel remote master station            ■PSM<sub>R□</sub> Parallel remote sub-master station            ■R<sub>□</sub> Remote I/O station            ■ Network No.            □ Station No.         </p>	<p>           ■MR Remote master station            ■R<sub>□</sub> Remote I/O station            ■ Network No.            □ Station No.         </p>	<ol style="list-style-type: none"> <li>1) Divide into two networks of which the network No. differs.</li> <li>2) Set the station that is not used after dividing the network as the reserved station.</li> <li>3) Use the inter-link data transfer function for data communication between the remote master stations.</li> </ol>

##### (b) Multiplex master system

- 1) MELSECNET/H can establish the system only when mounting on the following CPU.
  - Process CPU (Q12PHCPU, Q25PHCPU)
  - Redundant CPU (Q12PRHCPU, Q25PRHCPU)
- 2) For the MELSECNET/H, the multiplexed remote master station and the multiplexed remote sub-master station cannot be mounted on the same CPU. Mount the multiplexed remote master station and the multiplexed remote sub-master station on separate CPUs.

## 5.2 Gradually replacing A series remote I/O stations with Q series remote I/O stations

Use the existing A/AnS/QnA/QnAS series master stations without any change, and gradually replace the existing remote I/O stations with Q series stations by each station.

For network, MELSECNET/10 can be continuously used by utilizing Q series MELSECNET/H modules in MELSECNET/10 mode, and thus Q series remote I/O stations can be used together with remaining A/AnS/QnA/QnAS remote I/O stations.

### 5.2.1 List of MELSECNET/10 modules and the alternative modules

#### (1) Replacement of the A/AnS series

Network type	Station type	A/AnS series	Q series (alternative module)
Optical loop	Remote master station	AJ71LP21	Replacement not required
		A1SJ71LP21	
		AJ71LP21G	
	Remote I/O station	AJ72LP25	QJ72LP25-25 (MELSECNET/10 mode) <sup>*1</sup>
		AJ72QLP25	
		A1SJ72QLP25	
	AJ72LP25G	QJ72LP25G (MELSECNET/10 mode) <sup>*1</sup>	
Coaxial loop	Remote master station	AJ71LR21	The step-by-step replacement of the coaxial loop system is not possible. Consider the replacement of the coaxial loop system with the coaxial bus system.
		A1SJ71LR21	
	Remote I/O station	AJ72LR25	
		AJ72QLR25	
		A1SJ72QLR25	
Coaxial bus	Remote master station	AJ71BR11	Replacement not required
		A1SJ71BR11	
	Remote I/O station	AJ72BR15	QJ72BR15 (MELSECNET/10 mode) <sup>*1</sup>
		AJ72QBR15	
		A1SJ72QBR15	

\*1 Modules with a serial number (first five digits) of "15012" or later



## (2) Replacement of the QnA/QnAS series

Network type	Station type	QnA/QnAS series	Q series (alternative module)
Optical loop	Remote master station	AJ71QLP21	Replacement not required
		A1SJ71QLP21	
		AJ71QLP21S	
		A1SJ71QLP21S	
		AJ71QLP21G	
	Remote I/O station	AJ72QLP25	QJ72LP25-25 (MELSECNET/10 mode) <sup>*1</sup>
A1SJ72QLP25		QJ72LP25G (MELSECNET/10 mode) <sup>*1</sup>	
AJ72LP25G			
Coaxial loop	Remote master station	AJ71QLR21	The step-by-step replacement of the coaxial loop system is not possible. Consider the replacement of the coaxial loop system with the coaxial bus system.
		A1SJ71QLR21	
	Remote I/O station	AJ72QLR25	
		A1SJ72QLR25	
Coaxial bus	Remote master station	AJ71QBR11	Replacement not required
		A1SJ71QBR11	
	Remote I/O station	AJ72QBR15	QJ72BR15 (MELSECNET/10 mode) <sup>*1</sup>
		A1SJ72QBR15	

\*1 Modules with a serial number (first five digits) of "15012" or later

## 5.2.2 Module performance specifications comparisons

### (1) Comparison of AJ72LP25/AJ72QLP25/A1SJ72QLP25 and QJ72LP25-25 (MELSECNET/10 mode)

○: Compatible, △: Partial change required, ×: Incompatible

Item	Specifications			Compatibility	Precautions for replacement
	AJ72LP25	AJ72QLP25 A1SJ72QLP25	QJ72LP25-25 (MELSECNET/10 mode)		
Maximum number of link points per network	LX/LY	8192 points		○	
	LB	8192 points		○	
	LW	8192 points		○	
Maximum number of link points per station	<Remote master station → remote I/O station> $\{(LY + LB) \div 8 + (2 \times LW)\} \leq 1600$ bytes <Remote I/O station → remote master station> $(LY + LB) \div 8 + (2 \times LW) \leq 1600$ bytes			○	
Maximum number of I/O points per remote I/O station	$X + Y \leq 2048$ points	$X + Y \leq 2048$ points* <sup>1</sup>	$X + Y \leq 2048$ points	○	
Communication speed	10Mbps			○	
Communication method	Token ring method			○	
Synchronous type	Frame synchronization method			○	
Encoding method	NRZI coding (Non Return to Zero Inverted)			○	
Transmission method	Duplex loop			○	
Transmission format	HDLC standards (frame format)			○	
Maximum number of networks	255 (Total number of PLC to PLC networks and remote I/O networks)	239 (Total number of PLC to PLC networks and remote I/O networks)		△	Network No.240 to No.250 cannot be set. Replace them with unused network No.
Number of stations connected in one network	65 stations (Remote master station: 1, remote I/O station: 64)			○	
Applicable cable	SI optical cable, H-PCF optical cable, broad-band H-PCF optical cable, QSI optical cable			○	
Overall distance	30km			○	
Distance between stations	SI optical cable: 500m, H-PCF optical cable: 1km Broad-band H-PCF optical cable: 1km, QSI optical cable: 1km			○	
Error control system	CRC ( $X^{16} + X^{12} + X^5 + 1$ ) and retry by a time over			○	
RAS function	Loop-back function due to error detection or disconnection of a cable Diagnostic function for checking local link lines Abnormal detection using the link special relay and link special register Network monitoring and various diagnostic functions			○	
Transient transmission	Monitoring, program up/download with a peripheral device Dedicated link instruction			△	For comparison of dedicated link instructions, refer to Section 5.1.7.

\*1 For the A1SJ72QLP25, the maximum number of I/O points per remote I/O station is " $X + Y \leq 1024$  points".

## (2) Comparison of AJ72LP25G/AJ72QLP25G and QJ72LP25G (MELSECNET/10 mode)

○: Compatible, △: Partial change required, ×: Incompatible

Item	Specifications			Compatibility	Precautions for replacement
	AJ72LP25G	AJ72QLP25G	QJ72LP25G (MELSECNET/10 mode)		
Maximum number of link points per network	LX/LY	8192 points		○	
	LB	8192 points		○	
	LW	8192 points		○	
Maximum number of link points per station	<Remote master station → remote I/O station> $\{(LY + LB) \div 8 + (2 \times LW)\} \leq 1600$ bytes <Remote I/O station → remote master station> $\{(LY + LB) \div 8 + (2 \times LW)\} \leq 1600$ bytes			○	
Maximum number of I/O points per remote I/O station	$X + Y \leq 2048$ points		$X + Y \leq 2048$ points	○	
Communication speed	10Mbps			○	
Communication method	Token ring method			○	
Synchronous type	Frame synchronization method			○	
Encoding method	NRZI coding (Non Return to Zero Inverted)			○	
Transmission method	Duplex loop			○	
Transmission format	HDLC standards (frame format)			○	
Maximum number of networks	255 (Total number of PLC to PLC networks and remote I/O networks)	239 (Total number of PLC to PLC networks and remote I/O networks)		△	Network No.240 to No.250 cannot be set. Replace them with unused network No.
Number of stations connected in one network	65 stations (Master station: 1, remote I/O station: 64)			○	
Applicable cable	GI optical cable			○	
Overall distance	30km			○	
Distance between stations	GI optical cable: 2km			○	
Error control system	CRC ( $X^{16} + X^{12} + X^5 + 1$ ) and retry by a time over			○	
RAS function	Loop-back function due to error detection or disconnection of a cable Diagnostic function for checking local link lines Abnormal detection using the link special relay and link special register Network monitoring and various diagnostic functions			○	
Transient transmission	Monitoring, program up/download with a peripheral device Dedicated link instruction			△	For comparison of dedicated link instructions, refer to Section 5.1.7.

### (3) Comparison of AJ72BR15/AJ72QBR15/A1SJ72QBR15 and QJ72BR15 (MELSECNET/10 mode)

○ : Compatible, △ : Partial change required, × : Incompatible

Item	Specifications			Compatibility	Precautions for replacement
	AJ72BR15	AJ72QBR15 A1SJ72QBR15	QJ72BR15 (MELSECNET/10 mode)		
Maximum number of link points per network	LX/LY	8192 points		○	
	LB	8192 points		○	
	LW	8192 points		○	
Maximum number of link points per station	<Remote master station → remote I/O station> $\{(LY + LB) \div 8 + (2 \times LW)\} \leq 1600$ bytes <Remote I/O station → remote master station> $\{(LY + LB) \div 8 + (2 \times LW)\} \leq 1600$ bytes			○	
Maximum number of I/O points per remote I/O station	$X + Y \leq 2048$ points	$X + Y \leq 2048$ points*1	$X + Y \leq 2048$ points	○	
Communication speed	10Mbps			○	
Communication method	Token bus method			○	
Synchronous type	Frame synchronization method			○	
Encoding method	Manchester code			○	
Transmission method	Single bus			○	
Transmission format	HDLC standards (frame format)			○	
Maximum number of networks	255 (Total number of PLC to PLC networks and remote I/O networks)	239 (Total number of PLC to PLC networks and remote I/O networks)		△	Network No.240 to No.250 cannot be set. Replace them with unused network No.
Number of stations connected in one network	33 stations (Master station: 1, remote I/O station: 32)			○	
Applicable cable	3C-2V, 5C-2V, 5C-FB			○	
Overall distance	30km			○	
Distance between stations	3C-2V: 300m 5C-2V, 5C-FB: 500m			○	
Error control system	CRC ( $X^{16} + X^{12} + X^5 + 1$ ) and retry by a time over			○	
RAS function	Loop-back function due to error detection or disconnection of a cable Diagnostic function for checking local link lines Abnormal detection using the link special relay and link special register Network monitoring and various diagnostic functions			○	
Transient transmission	Monitoring, program up/download with a peripheral device Dedicated link instruction			△	For comparison of dedicated link instructions, refer to Section 5.1.7

\*1 For the A1SJ72QBR15, the maximum number of I/O points per remote I/O station is " $X + Y \leq 1024$  points".

### 5.2.3 Functional comparisons

To use a MELSECNET/H remote I/O module (MELSECNET/10 mode), the CPU module on the master station must be an AnU/AnUS/QnA/QnAS series module. For details on functions of a remote I/O module, refer to a manual for the CPU module used on the master station because the functions differ depending on which CPU module is used on the master station.

The following table lists function differences among module series.

Item	Description		Compatibility	Precautions for replacement
	A/AnS/QnA/QnAS series MELSECNET/10 module	Q series MELSECNET/H module (MELSECNET/10 mode)		
Communicating with a special function module (Cyclic transfer function)	Performs communications with each module on the remote I/O station using X/Y (LX/LY) and B/W (LB/LW).		○	
Dedicated link instruction	Reads or writes data from/to the buffer memory of the special function module on the remote I/O station.		△	Check and modify a program because buffer memory addresses of intelligent function modules differ between A/AnS/QnA/QnAS series and Q series.
I/O assignment function	Sets the module configuration of the remote I/O station.		△	Set the configuration with the PLC parameter of the remote I/O module.*1
ZNFR/ZNTO instruction access number setting function	Sets the number of transient transmissions that can be executed during one link scan (a total of entire one network).		△	The number of transient transmissions executed during one link scan differs depending on the total number of normal stations. The number of transient transmissions executed for one station is the same, though.
Blown fuse error and input/output verification error check disabled function	Sets whether to enable or disable the error check of a blown fuse error and an input/output verification error.		△	Set whether to enable or disable the error check with the PLC parameter of the remote I/O module.
Operation mode at an error	Sets an operation mode to be used when a blown fuse error or an input/output verification error occurs.		△	Set an operation mode with the PLC parameter of the remote I/O module.

\*1 Change the network parameter of the master station as well. For details, refer to Section 5.2.6.

## 5.2.4 Switch setting comparisons

### (1) Switch setting comparisons of remote master stations

The switch setting change is not required because the remote master station is not replaced.

### (2) Switch setting comparisons of remote I/O stations

Switch name	Description		Compatibility	Precautions for replacement
	A/AnS/QnA/QnAS series MELSECNET/10 module	Q series MELSECNET/H module (MELSECNET/10 mode)		
Mode setting switch	Sets the mode. <Setting range> 0: Online 2: Offline 3: Loop test (forward loop)*2 4: Loop test (reverse loop)*2 5: Station-to-station test (master station) 6: Station-to-station test (normal station) 7: Self-loopback test 8: Internal self-loopback test 9: H/W test F: Station No. check	[Using QJ72LP25-25] Sets the mode. <Setting range> 0: Online (10Mbps) 1: Self-loopback test (10Mbps) 2: Internal self-loopback test (10Mbps) 3: Hardware test (10Mbps) 4: Online (25Mbps) 5: Self-loopback test (25Mbps) 6: Internal self-loopback test (25Mbps) 7: Hardware test (25Mbps) 8: Online (MELSECNET/10 mode)*1	△	<ul style="list-style-type: none"> <li>When using a MELSECNET/H module in MELSECNET/10 mode, set the mode to "8".</li> <li>Set offline and loop test in GX Works2 or GX Developer network parameters.</li> <li>Substitute the forward loop/reverse loop test for the station-to-station test.</li> <li>Check network No., group No. and station No. in GX Works2 or GX Developer network diagnostics (host information).</li> </ul>
		[Using QJ72LP25G and QJ72BR15] Sets the mode. <Setting range> 0: Online 1: Self-loopback test 2: Internal self-loopback test 3: Hardware test 8: Online (MELSECNET/10 mode)*1		

\*1 This mode (8; Online (MELSECNET/10 mode)) is added to a module with a serial number (first five digits) of "15012" or later.

\*2 This mode is not used for the coaxial bus system.

## 5.2.5 Parameter comparisons

### (1) Parameters of remote master station

Basically, the parameter change is not required because A/AnS/QnA/QnAS series modules are continuously used for the remote master station.

However, for a Q series MELSECNET/H remote I/O module (MELSECNET/10 mode), some parameters must be set at the remote I/O station instead of at the master station, and therefore the setting change of an existing module at the master station is required. For details, refer to Section 5.2.6.

### (2) Parameters of remote I/O station

When mounting an intelligent function module on a remote I/O station, set parameters.

When the remote I/O station consists of only I/O modules, the modules operate without parameter settings. (In such a case, the modules operate with the default values.)

○: Compatible, △: Partial change required, ×: Incompatible

Parameter name	Description		Compatibility	Precautions for replacement
	A/AnS/QnA/QnAS series MELSECNET/10 module	Q series MELSECNET/H module (MELSECNET/10 mode)		
PLC parameter	-	PLC system setting	△	<ul style="list-style-type: none"> <li>New parameter of MELSECNET/H (The number of empty slots is set.)</li> <li>For an A/AnS/QnA/QnAS series module, the number is set in I/O assignments of the network parameter at the master station.</li> </ul>
	-	PLC RAS setting	△	<ul style="list-style-type: none"> <li>New parameter of MELSECNET/H (The operation mode to be used or whether to enable the error check at an error are set.)</li> <li>For an A/AnS/QnA/QnAS series module, the PLC RAS setting of PLC parameter at the master station is selected to the remote I/O network.</li> </ul>
	-	Operation setting	-	<ul style="list-style-type: none"> <li>New parameter of MELSECNET/H (The parameters for data transmission between devices are set.)</li> </ul>
	-	I/O assignment setting	△	<ul style="list-style-type: none"> <li>New parameter of MELSECNET/H (The I/O assignments of the remote I/O station are set.)</li> <li>For an A/AnS/QnA/QnAS series module, the I/O assignments are set in I/O assignments of the network parameter at the master station. Therefore, at the replacement, if the I/O assignments are already set at the A/AnS/QnA/QnAS series module on the master station, the setting change is required.</li> <li>To mount an intelligent function module on a remote I/O station, the switch setting is required for the I/O assignments.</li> </ul>
Network parameter	-	Ethernet	-	<ul style="list-style-type: none"> <li>New parameter of MELSECNET/H (The network parameter of an Ethernet module mounted on the remote I/O station is set.)</li> </ul>
		CC-Link	-	<ul style="list-style-type: none"> <li>New parameter of MELSECNET/H (The network parameter of a CC-Link module mounted on the remote I/O station is set.)</li> </ul>
Remote password	-	Remote password setting	-	<ul style="list-style-type: none"> <li>New parameter of MELSECNET/H (The remote password of a module (such as an Ethernet module or a serial communication module) mounted on the remote I/O station is set.)</li> </ul>

## 5.2.6 Program comparisons

This section describes how to modify the existing programs when replacing MELSECNET/10 remote I/O stations with MELSECNET/H (MELSECNET/10 mode) remote I/O stations.

### (1) Link special relay (SB)/link special register

Program modifications related to link special relay (SB) and link special register (SW) are not required because the link special relay (SB) and link special register (SW) of the CPU module on the master station are used.

For details, refer to either of following manuals according to the CPU module used on the master station.

Type MELSECNET/10 Network System (Remote I/O network) Reference Manual

For QnA/Q4AR MELSECNET/10 Network System Reference Manual

### (2) Network parameters

#### (a) Master station

The items specific to remote I/O stations (such as I/O assignments of a remote I/O station) must be set at the remote I/O station. Therefore, delete these items from the network parameter of the master station. For details on the items set at the remote I/O station, refer to Section 5.2.5.

#### (b) Remote I/O station

Set the necessary parameters (refer to Section 5.2.5) at the remote I/O station.

If the parameters are not set, modules operate with the default settings and these operations may differ from the desired ones.

When mounting an intelligent function module, configure the switch setting for I/O assignments.

The figures below show the setting example of I/O assignments on the following conditions; the system has one remote I/O station, the system configurations before and after the replacement are the same, and an intelligent function module is mounted on the remote I/O station.

I/O assignments of the remote I/O station (set in the network parameter at the existing master station)

	StationNo	Slot	Type	Model name	Points
0	1	0(0-0)	Special		32points
1	1	1(0-1)	Input		32points
2	1	2(0-2)	Output		32points

Delete the parameters to set them on the remote I/O station side.



I/O assignments of the remote I/O station (set in the network parameter at the remote I/O station after the replacement)

The address change is not required when the number of occupied points and start XY address are set on the remote I/O station side.

No.	Slot	Type	Model Name	Points	Start XY	Switch Setting
0	Remote I/O Station	Remote I/O Station	QJ72LP25-25			
1	0(*-0)	Intelligent	Q62DAN	32Points	0000	
2	1(*-1)	Input	QX41	16Points	0020	
3	2(*-2)	Output	QY41P	16Points	0040	
4	3(*-3)					
5	4(*-4)					
6	5(*-5)					
7	6(*-6)					

Assigning the I/O address is not necessary as the CPU does it automatically.  
Leaving this setting blank will not cause an error to occur.

The switch setting is required when an intelligent function module is used.

Switch setting example

No.	Slot	Type	Model Name	Switch1	Switch2	Switch3	Switch4	Switch5
0	Remote I/O Station	Remote I/O Station	QJ72LP25-25					
1	0(*-0)	Intelligent	Q62DAN	0044	0000	0000	0000	0000
2	1(*-1)	Input	QX41					
3	2(*-2)	Output	QY41P					
4	3(*-3)							

### (3) Utilizing existing programs

If the system configurations before and after the replacement are the same, program modifications are not required.

When an intelligent function module is mounted on the remote I/O station, the buffer memory read or write functions using the dedicated link instruction of the CPU module on the master station. In such a case, if the specifications such as I/O signals or buffer memory addresses are different between the modules before and after the replacement, a program modification is required.

The figure below shows the example of modifying the program related to the dedicated link instruction when the CPU module on the master station is the AnUCPU and the A62DA (analog output module) is replaced with the Q62DAN.

Program related to the dedicated link instruction of the existing AnUCPU

\* Write data to the buffer memory area in the analog output side.



\* Check the output value write completion.

\* Change SUB H0 into SUB H1 because the buffer memory address for writing the analog output value of the Q62DAN changes H1.

For details on replacements of intelligent function modules, refer to the following.

Transition from MELSEC-A/QnA (Large Type) Series to Q Series Handbook (Intelligent Function Modules)

Transition from MELSEC-AnS/QnAS (Small Type) Series to Q Series Handbook (Intelligent Function Modules)

### 5.2.7 Last stage of the replacement

This section describes the last stage of the step-by-step replacement of the MELSECNET/10 remote I/O stations with the MELSECNET/H remote I/O stations. The replacement is conducted by using the MELSECNET/10 mode of MELSECNET/H remote I/O modules.

#### (1) Last stage of the replacement

A MELSECNET/H remote I/O module (MELSECNET/10 mode) can be used when the CPU module on the master station is A/AnS/QnA/QnAS series.

When replacing the CPU module on the master station with a Q series module, replace the network as well (from MELSECNET/10 remote I/O to MELSECNET/H remote I/O). In this case, Q series modules are used for all remote I/O stations.

The last stage of the step-by-step replacement of the MELSECNET/10 remote I/O network is when the CPU module on the master station is replaced with a Q series module.

#### (2) How to replace the master station

Replace the master station in the same way as the MELSECNET/10 remote I/O is collectively replaced. For details, refer to Section 5.1.

#### (3) How to replace remote I/O stations

For MELSECNET/H remote I/O modules at the step-by-step replacement, the mode setting switches are set to MELSECNET/10 mode "8".

At the last stage of the replacement where the network is replaced with the MELSECNET/H remote I/O, if the mode setting switches are changed to Online (MELSECNET/H mode) "0" or "4", all of the modules on the stations can be used as they are.

Note that to use the buffer memory read or write of an intelligent function module, program checks and modifications are required for the dedicated link instructions (from the A series instructions to the Q series instructions).

# 6 REPLACEMENT OF CC-LINK

## 6.1 List of CC-Link Alternative Models

### (1) Replacement of the A/AnS series

A/AnS series	Alternative models
AJ61BT11	QJ61BT11N*1
A1SJ61BT11	

### (2) Replacement of the QnA/QnAS series

QnA/QnAS series	Alternative models
AJ61QBT11	QJ61BT11N*1
A1SJ61QBT11	

- \*1 The number of mountable CC-Link modules depending on Q series CPU module type is as follows:  
 Universal model QCPU: 64  
 Up to eight modules can be set using parameters of GX Works2 or GX Developer. To use more than eight modules, set the parameters using dedicated instructions.  
 For details, refer to the CC-Link System Master/Local Module User's Manual.

## 6.2 Specifications Comparisons

### 6.2.1 Module specifications comparisons

#### (1) A/AnS series

○ : Compatible, △: Partial change required, × : Incompatible

Item	Specifications		Compat- ibility	Precautions for replacement
	AJ61BT11/A1SJ61BT11	QJ61BT11N		
Transmission speed	Can be selected from 156kbps/625kbps/2.5Mbps/5Mbps/10Mbps.		○	
Max. cable overall distance (Max. transmission distance)	Differs depending on the transmission speed. (Refer to the manual.)		○	
Max. number of stations (For master station)	64 stations Note that it has to be satisfied with the following conditions. $\{(1 \times a) + (2 \times b) + (3 \times c) + (4 \times d)\} \leq 64$ a: Number of 1-station occupied modules b: Number of 2-station occupied modules c: Number of 3-station occupied modules d: Number of 4-station occupied modules $\{(16 \times A) + (54 \times B) + (88 \times C)\} \leq 2304$ A: Number of remote I/O stations $\leq 64$ stations B: Number of remote device stations $\leq 42$ stations C: Number of local stations, standby master stations and intelligent device stations $\leq 26$ stations		○	
Number of occupied stations (For local station)	1 to 4 stations (Switched with DIP switch)	1 to 4 stations (Switched with GX Works2 or GX Developer parameter settings)	○	GX Works2 or GX Developer parameter settings are required.
Maximum number of link points per system	Remote I/O (RX, RY) : 2048 points Remote register (RWw) : 256 points Remote register (RWr) : 256 points		○	
Remote station/local station Link points per station	Remote I/O (RX, RY) : 32 points (Local station: 30 points) Remote register (RWw) : 4 points Remote register (RWr) : 4 points		○	
Communication method	Broad cast polling method		○	
Synchronous type	Frame synchronization method	Flag synchronization method	△	Nothing to be noted though the methods are different.
Encoding method	NRZI method		○	
Transmission method	Bus (RS-485)		○	
Transmission format	HDLC standards		○	
Error control system	CRC ( $X^{16} + X^{12} + X^5 + 1$ )		○	
Connection cable	CC-Link dedicated cable/CC-Link dedicated high-performance cable/Ver.1.10 compatible CC-Link dedicated cable		○	Refer to Section 6.2.2.
RAS function	<ul style="list-style-type: none"> <li>Automatic return function</li> <li>Local station detach function</li> <li>Error detection with link special relay/register</li> </ul>		○	
Number of parameter registrations to E <sup>2</sup> PROM	10,000 times	-	△	GX Works2 or GX Developer parameter settings are performed instead of the parameter registration to E <sup>2</sup> PROM.
Number of occupied I/O points	32 points (I/O assignment: special 32 points)	32 points (I/O assignment: intelli 32 points)	○	

## (2) QnA/QnAS series

○ : Compatible, △: Partial change required, × : Incompatible

Item	Specifications		Compat- ibility	Precautions for replacement
	AJ61QBT11/A1SJ61QBT11	QJ61BT11N		
Transmission speed	Can be selected from 156kbps/625kbps/2.5Mbps/5Mbps/10Mbps.		○	
Max. cable overall distance (Max. transmission distance)	Differs depending on the transmission speed. (Refer to the manual.)		○	
Max. number of stations (For master station)	64 stations Note that it has to be satisfied with the following conditions.  $\{(1 \times a) + (2 \times b) + (3 \times c) + (4 \times d)\} \leq 64$ a: Number of 1-station occupied modules b: Number of 2-station occupied modules c: Number of 3-station occupied modules d: Number of 4-station occupied modules  $\{(16 \times A) + (54 \times B) + (88 \times C)\} \leq 2304$ A: Number of remote I/O stations $\leq 64$ stations B: Number of remote device stations $\leq 42$ stations C: Number of local stations, standby master stations and intelligent device stations $\leq 26$ stations		○	
Number of occupied stations (For local station)	1 to 4 stations (Switched with DIP switch)	1 to 4 stations (Switched with GX Works2 or GX Developer parameter settings)	△	GX Works2 or GX Developer parameter settings are required.
Maximum number of link points per system	Remote I/O (RX, RY) : 2048 points Remote register (RWw) : 256 points Remote register (RWr) : 256 points		○	
Remote station/local station Link points per station	Remote I/O(RX, RY) : 32 points (Local station: 30 points) Remote register (RWw) : 4 points Remote register (RWr) : 4 points		○	
Communication method	Broad cast polling method		○	
Synchronous type	Frame synchronization method	Flag synchronization method	△	Nothing to be noted though the methods are different.
Encoding method	NRZI method		○	
Transmission method	Bus (RS-485)		○	
Transmission format	HDLC standards		○	
Error control system	CRC ( $X^{16} + X^{12} + X^5 + 1$ )		○	
Connection cable	CC-Link dedicated cable/CC-Link dedicated high-performance cable/Ver.1.10 compatible CC-Link dedicated cable		○	Refer to Section 6.2.2.
RAS function	<ul style="list-style-type: none"> <li>• Automatic return function</li> <li>• Local station detach function</li> <li>• Error detection with link special relay/register</li> </ul>		○	
Number of parameter registrations to E <sup>2</sup> PROM	10,000 times	-	△	GX Works2 or GX Developer parameter settings are performed instead of the parameter registration to E <sup>2</sup> PROM.
Number of occupied I/O points	32 points (I/O assignment: special 32 points)	32 points (I/O assignment: intelli 32 points)	○	

### 6.2.2 Cable performance comparisons

CC-Link dedicated cable used on the A/AnS/QnA/QnAS series can be also used on the Q series. For specifications of CC-Link dedicated cable, refer to CC-Link Partner Association home page: [www.cc-link.org](http://www.cc-link.org)

## 6.3 Functional Comparisons

## (1) A/AnS series

○ : Compatible, △ : Partial change required, × : Incompatible

Item	Specifications		Compat- ibility	Precautions for replacement
	AJ61BT11/A1SJ61BT11	QJ61BT11N		
Communication between master station and remote I/O station	The communication of ON/OFF information with remote I/O station is performed.		○	
Communication between master and remote device stations	The communication of ON/OFF information and numerical data with remote device station is performed.		○	
Communication between master station and local station	The communication of ON/OFF information and numerical data with local station is performed.		○	
Communication between master and intelligent device stations	The communication is performed with intelligent device station using cyclic transmission and transient transmission.		○	
Reserved station function	By setting remote station and local station, which are to be connected in the future, as reserved stations, these stations are not treated as data link faulty stations. If a connected module is specified, no data link is available.		○	
Error invalid station function	Remote station and local station that cannot perform data link due to the power supply off, etc. will not be treated as data link faulty stations with this function.		○	
Data link status setting at master station programmable controller CPU error	The data link status when operation continuation error occurs on the master station programmable controller CPU can be set.		○	
Parameter registration to E <sup>2</sup> PROM	Parameter writing is not required at each startup of master module by registering parameters to E <sup>2</sup> PROM of master module.	-	△	GX Works2 or GX Developer parameter settings are performed instead of the parameter registration to E <sup>2</sup> PROM.
Data link faulty station input data status setting	The input (received) data status (cleared/hold) from the station that has data link error caused by the power supply off, etc. can be set.		○	
Module reset function by sequence program	Resetting can be performed by the sequence program without resetting programmable controller CPU in the case the switch setting is changed or an error has occurred in a module.	-	×	When the switch setting is changed, turn the power supply of programmable controller system OFF → ON or reset the programmable controller CPU.
Data link stop/restart	The stop and restart of data link is available during the data link execution.		○	
Automatic return function	The module disconnected from data link by the power supply off, etc. can automatically return to data link, when restored to the normal status.		○	
Local station detach function	The module that cannot perform data link due to the power supply off, etc. is disconnected and data link is kept with normal modules only.		○	
Data link status check (SB/SW)	Data link status can be checked. This check can be used for the interlock etc. of sequence program.		○	

(To next page)



○ : Compatible, △ : Partial change required, × : Incompatible

Item	Specifications		Compat- ibility	Precautions for replacement
	AJ61BT11/A1SJ61BT11	QJ61BT11N		
Offline test	The following tests can be performed. • Hardware test: Standalone module operation check • Line test: Module connection status check • Parameter check test: Parameter setting check	The following tests can be performed. • Hardware test: Standalone module operation check • Line test: Module connection status check	△	The specification method of hardware test/line test differs. For details on the specification method, refer to the manual. Check the set parameter in GX Works2 or GX Developer network parameters.
Parameter registration function	The following two types of parameters are set using the sequence program (TO instruction) or dedicated instructions. • Network parameter • Automatic refresh parameter	The following two types of parameters are set using GX Works2 or GX Developer. • Network parameter • Automatic refresh parameter	△	Change from the parameter settings in the sequence program (TO instruction) or with dedicated instructions to the parameter settings with GX Works2 or GX Developer.
Scan synchronous function	Synchronous mode: Data link with scan synchronized with sequence program is available. Asynchronous mode: Data link not synchronized with sequence program is available.		○	
Standby master function	Data link can be continuously performed by switching to the standby master station at the master station error.		○	
Dedicated instruction (RIRD, RIWT, RIRCV, RISEND, RIFR, RITO)	Transient transmission to intelligent device station and local station is available using dedicated instructions.		△	Change the sequence program as instruction formats differ.
Remote I/O net mode	Communication is available for master station and remote I/O station only.		△	Delete RRPA instruction and set parameters with GX Works2 or GX Developer.
Temporary error invalid station specify function	Module replacement is available without detecting error of the faulty remote station during online.		○	

## (2) QnA/QnAS series

○ : Compatible, △ : Partial change required, × : Incompatible

Item	Specifications		Compat- ibility	Precautions for replacement
	AJ61QBT11/A1SJ61QBT11	QJ61BT11N		
Communication between master station and remote I/O station	The communication of ON/OFF information with remote I/O station is performed.		○	
Communication between master and remote device stations	The communication of ON/OFF information and numerical data with remote device station is performed.		○	
Communication between master station and local station	The communication of ON/OFF information and numerical data with local station is performed.		○	
Communication between master and intelligent device stations	The communication is performed with intelligent device station using cyclic transmission and transient transmission.		○	
Reserved station function	By setting remote station and local station, which are to be connected in the future, as reserved stations, these stations are not treated as data link faulty stations. If a connected module is specified, no data link is available.		○	
Error invalid station function	Remote station and local station that cannot perform data link due to the power supply off, etc. will not be treated as data link faulty stations with this function.		○	
Data link status setting at master station programmable controller CPU error	The data link status when operation continuation error occurs on the master station programmable controller CPU can be set.		○	
Parameter registration to E <sup>2</sup> PROM	Parameter writing is not required at each startup of master module by registering parameters to E <sup>2</sup> PROM of master module.	-	△	GX Works2 or GX Developer parameter settings are performed instead of the parameter registration to E <sup>2</sup> PROM.
Data link faulty station input data status setting	The input (received) data status (cleared/held) from the station that has data link error caused by the power supply off, etc. can be set.		○	
Module reset function by sequence program	Resetting can be performed by the sequence program without resetting programmable controller CPU in the case the switch setting is changed or an error has occurred in a module.	-	×	When the switch setting is changed, turn the power supply of programmable controller system OFF → ON or reset the programmable controller CPU.
Data link stop/restart	The stop and restart of data link is available during the data link execution.		○	
Automatic return function	The module disconnected from data link by the power supply off, etc. can automatically return to data link, when restored to the normal status.		○	
Local station detach function	The module that cannot perform data link due to the power supply off, etc. is disconnected and data link is kept with normal modules only.		○	
Data link status check (SB/SW)	Data link status can be checked. This check can be used for the interlock etc.of sequence program.		○	

(To next page)

○ : Compatible, △: Partial change required, × : Incompatible

Item	Specifications		Compat- ibility	Precautions for replacement
	AJ61QBT11/A1SJ61QBT11*1	QJ61BT11N*2		
Offline test	The following tests can be performed. • Hardware test: Standalone module operation check • Line test: Module connection status check • Parameter check test: Parameter setting check	The following tests can be performed. • Hardware test: Standalone module operation check • Line test: Module connection status check	△	The specification method of hardware test/line test differs. For details on the specification method, refer to the manual. Check the set parameter in GX Works2 or GX Developer network parameters.
Parameter registration function	The following two types of parameters are set using GX Works2 or GX Developer. • Network parameter • Automatic refresh parameter		○	
Scan synchronous function	Synchronous mode: Data link with scan synchronized with sequence program is available. Asynchronous mode: Data link not synchronized with sequence program is available.		○	
Standby master function	Data link can be continuously performed by switching to the standby master station at the master station error.		○	
Dedicated instruction (RIRD, RIWT, RIRCV, RISEND, RIFR, RITO)	Transient transmission to intelligent device station and local station is available using dedicated instructions.		△	Change the sequence program as instruction formats differ.
Send/receive instruction (SEND, RECV, READ, SREAD, WRITE, SWRITE, REQ)	Data sending/receiving to/from other station on CC-Link is available. Data reading/writing from/to other station is also available.	-	△	Replace READ, WRITE instructions with dedicated instructions (RIRD, RIWT). Other instruction cannot be replaced.
Remote I/O net mode	Communication is available for master station and remote I/O station only.		△	Set parameters with GX Works2 or GX Developer.
Temporary error invalid station specify function	Module replacement is available without detecting error of the faulty remote station during online.		○	
Online test function	Line test and link start/stop, etc. can be performed with GX Works2 or GX Developer.		○	
Monitoring and diagnostics	Monitoring and diagnosing can be performed from GX Works2 or GX Developer.		○	

\*1 Use GX Developer.

\*2 Use GX Works2 or GX Developer.

## 6.4 Switch Settings Comparisons

## (1) A/AnS series

○ : Compatible, △ : Partial change required, × : Incompatible

Switch name	Specifications		Compat- ibility	Precautions for replacement
	AJ61BT11/A1SJ61BT11	QJ61BT11N		
Station number setting switch	Sets the station No. of the module. <Setting range> • For remote net mode Master station: 0 Local station: 1 to 64 Standby master station: 1 to 64 • For remote I/O net mode Master station: 1 to 64 (The last station No. of remote I/O station is set.)	Sets the station No. of the module. <Setting range> Master station: 0 Local station: 1 to 64 Standby master station: 1 to 64	△	Sets the last station No. at remote I/O net mode with GX Works2 or GX Developer.
Mode setting switch	Sets the operation status of the module.	Sets the transmission speed and operating status of the module.	△	The mode setting and the transmission rate setting are performed with one switch. The remote net mode and remote I/O net mode are specified in GX Works2 or GX Developer parameter settings.
Transmission speed setting switch	Sets the transmission speed of the module.			
Condition setting switch	Sets the operation conditions. <Settings> • Station type • Input data status of data link faulty station • Number of occupied stations • Module mode	-	△	The operating conditions are set in the parameter settings of GX Works2 or GX Developer. Module mode setting is not required.

## (2) QnA/QnAS series

○ : Compatible, △ : Partial change required, × : Incompatible

Switch name	Specifications		Compat- ibility	Precautions for replacement
	AJ61QBT11/A1SJ61QBT11	QJ61BT11N		
Station number setting switch	Sets the station No. of the module. <Setting range> • For remote net mode Master station: 0 Local station: 1 to 64 Standby master station: 1 to 64 • For remote I/O net mode Master station: 1 to 64 (The last station No. of remote I/O station is set.)	Sets the station No. of the module. <Setting range> Master station: 0 Local station: 1 to 64 Standby master station: 1 to 64	△	Sets the last station No. at remote I/O net mode with GX Works2 or GX Developer.
Mode setting switch	Sets the operation status of the module.	Sets the transmission speed and operating status of the module.	△	The mode setting and the transmission rate setting are performed with one switch. The remote net mode and remote I/O net mode are specified in GX Works2 or GX Developer parameter settings.
Transmission speed setting switch	Sets the transmission speed of the module.			
Condition setting switch	Sets the operation conditions. <Settings> • Station type • Input data status of data link faulty station • Number of occupied stations	-	△	The operating conditions are set in the parameter settings of GX Works2 or GX Developer.

## 6.5 Parameter Comparisons

## (1) A/AnS series

○ : Compatible, △ : Partial change required, × : Incompatible

Parameter name	Specifications		Compat- ibility	Precautions for replacement
	AJ61BT11/A1SJ61BT11	QJ61BT11N		
Network parameter	Set this parameter with the sequence program (TO instruction) or with dedicated instruction (RLPA instruction).	Set this parameter with GX Works2/GX Developer or with dedicated instruction (RLPASET instruction).	△	Newly set the parameter with GX Works2/GX Developer or the dedicated instruction (RLPASET instruction). <sup>*1 *2</sup> Specify [Remote net Ver.1 mode] or [Remote I/O net mode] for the mode.
Automatic refresh parameter	Read/write cyclic data with FROM/TO instruction or set this parameter with dedicated instruction (RRPA instruction).	Perform the automatic refresh setting with GX Works2/GX Developer or read/write cyclic data with FROM/TO instruction.	△	Perform the automatic refresh setting with GX Works2/GX Developer or read/write cyclic data with FROM/TO instruction. When setting the network parameter with dedicated instruction (RLPASET instruction), read/write cyclic data with FROM/TO instruction.

## (2) QnA/QnAS series

○ : Compatible, △ : Partial change required, × : Incompatible

Parameter name	Specifications		Compat- ibility	Precautions for replacement
	AJ61QBT11/A1SJ61QBT11	QJ61BT11N		
Network parameter	Set this parameter with GX Developer or sequence program (TO instruction).	Set this parameter with GX Works2/GX Developer or with dedicated instruction (RLPASET instruction).	△	Newly set the parameter with GX Works2/GX Developer or the dedicated instruction (RLPASET instruction). <sup>*1 *2</sup> Specify [Remote net Ver.1 mode] or [Remote I/O net mode] for the mode.
Automatic refresh parameter	Perform the automatic refresh setting with GX Developer or read/write cyclic data with FROM/TO instruction.	Perform the automatic refresh setting with GX Works2/GX Developer or read/write cyclic data with FROM/TO instruction.	△	Set the automatic refresh with GX Works2/GX Developer or read/write cyclic data with FROM/TO instruction. When setting the network parameter with dedicated instruction (RLPASET instruction), read/write cyclic data with FROM/TO instruction.

\*1 Parameter setting of Q series CC-Link modules

Parameters can be set on up to eight modules using GX Works2 or GX Developer. For the settings of the 9th module or later, use the dedicated instruction.

For details, refer to the CC-Link System Master/Local Module User's Manual.

\*2 Delete the program for the network parameter setting of the existing module.

## 6.6 Program Comparisons

### 6.6.1 Comparison of I/O signals

#### (1) A/AnS series

##### (a) Input signal

○ : Compatible, △: Partial change required, × : Incompatible

Input signal	Signal name		Compat- ibility	Precautions for replacement
	AJ61BT11/A1SJ61BT11	QJ61BT11N		
Xn0	Module error	Module error	○	
Xn1	Data link status at host station	Data link status at host station	○	
Xn2	Parameter setting status	Prohibited to use	△	Delete the sequence program of the section corresponding to the function, and check with SB006D (Parameter setting status).
Xn3	Data link status of other station	Data link status of other station	○	
Xn4	Module reset acceptance complete	Prohibited to use	×	Delete the sequence program of the section corresponding to the function. When the switch setting is changed, turn the power supply of programmable controller system OFF → ON or reset the programmable controller CPU.
Xn5	Prohibited to use	Prohibited to use	○	
Xn6	Data link startup by buffer memory parameter normal completion	Prohibited to use	△	Delete the sequence program of the section corresponding to the function, and set parameters with GX Works2/GX Developer or with dedicated instruction (RLPASET instruction).
Xn7	Data link startup by buffer memory parameter error completion			
Xn8	Data link startup by E <sup>2</sup> PROM parameter normal completion			
Xn9	Data link startup by E <sup>2</sup> PROM parameter error completion			
XnA	Parameter registration to E <sup>2</sup> PROM normal completion			
XnB	Parameter registration to E <sup>2</sup> PROM error completion			
XnC	Prohibited to use	Prohibited to use	○	
XnD	E <sup>2</sup> PROM erasure normal completion	Prohibited to use	△	Delete the sequence program of the section corresponding to the function, and set parameters with GX Works2/GX Developer or with dedicated instruction (RLPASET instruction).
XnE	E <sup>2</sup> PROM erasure abnormal completion			
XnF	Module ready	Module ready	○	
X(n+1)0	Prohibited to use	Prohibited to use	○	
X(n+1)1				
X(n+1)2				
X(n+1)3				
X(n+1)4				
X(n+1)5				
X(n+1)6				
X(n+1)7				
X(n+1)8				
X(n+1)9				
X(n+1)A				
X(n+1)B				
X(n+1)C				
X(n+1)D				
X(n+1)E				
X(n+1)F				

## (b) Output signal

○ : Compatible, △ : Partial change required, × : Incompatible

Output signal	Signal name		Compat- ibility	Precautions for replacement
	AJ61BT11/A1SJ61BT11	QJ61BT11N		
Yn0	Refresh specification	Prohibited to use	△	Refreshed automatically. Delete the sequence program of the section corresponding to the function.
Yn1	Prohibited to use	Prohibited to use	○	
Yn2				
Yn3				
Yn4				
Yn4	Module reset request	Prohibited to use	×	Delete the sequence program of the section corresponding to the function. When the switch setting is changed, turn the power supply of programmable controller system OFF → ON or reset the programmable controller CPU.
Yn5	Prohibited to use	Prohibited to use	○	
Yn6	Data link startup request from buffer memory parameters	Prohibited to use	△	Delete the sequence program of the section corresponding to the function, and set parameters with GX Works2/GX Developer or with dedicated instruction (RLPASET instruction).
Yn7	Prohibited to use	Prohibited to use	○	
Yn8	Data link startup request from E <sup>2</sup> PROM parameters	Prohibited to use	△	Delete the sequence program of the section corresponding to the function, and set parameters with GX Works2/GX Developer or with dedicated instruction (RLPASET instruction).
Yn9	Prohibited to use	Prohibited to use	○	
YnA	Parameter registration request to E <sup>2</sup> PROM	Prohibited to use	△	Delete the sequence program of the section corresponding to the function, and set parameters with GX Works2/GX Developer or with dedicated instruction (RLPASET instruction).
YnB	Prohibited to use	Prohibited to use	○	
YnC				
YnD				
YnD	E <sup>2</sup> PROM erasure request	Prohibited to use	△	Delete the sequence program of the section corresponding to the function, and set parameters with GX Works2/GX Developer or with dedicated instruction (RLPASET instruction).
YnE	Prohibited to use	Prohibited to use	○	
YnF				
Y(n+1)0				
Y(n+1)1				
Y(n+1)2				
Y(n+1)3				
Y(n+1)4				
Y(n+1)5				
Y(n+1)6				
Y(n+1)7				
Y(n+1)8				
Y(n+1)9				
Y(n+1)A				
Y(n+1)B				
Y(n+1)C	Bank switch specification of buffer memory	Prohibited to use	△	Bank switching is not required. (Refer to Section 6.6.2.)
Y(n+1)D	Prohibited to use	Prohibited to use	○	
Y(n+1)E				
Y(n+1)F				



## (2) QnA/QnAS series

## (a) Input signal

○ : Compatible, △ : Partial change required, × : Incompatible

Input signal	Signal name		Compat- ibility	Precautions for replacement
	AJ61QBT11/A1SJ61QBT11	QJ61BT11N		
Xn0	Module error	Module error	○	
Xn1	Data link status at host station	Data link status at host station	○	
Xn2	Parameter setting status	Prohibited to use	△	Delete the sequence program of the section corresponding to the function, and check with SB006D (Parameter setting status).
Xn3	Data link status of other station	Data link status of other station	○	
Xn4	Module reset acceptance complete	Prohibited to use	×	Delete the sequence program of the section corresponding to the function. When the switch setting is changed, turn the power supply of programmable controller system OFF → ON or reset the programmable controller CPU.
Xn5	Prohibited to use	Prohibited to use	○	
Xn6	Data link startup by buffer memory parameter normal completion	Prohibited to use	△	Delete the sequence program of the section corresponding to the function, and set parameters with GX Works2/GX Developer or with dedicated instruction (RLPASET instruction).
Xn7	Data link startup by buffer memory parameter error completion			
Xn8	Data link startup by E <sup>2</sup> PROM parameter normal completion			
Xn9	Data link startup by E <sup>2</sup> PROM parameter error completion			
XnA	Parameter registration to E <sup>2</sup> PROM normal completion			
XnB	Parameter registration to E <sup>2</sup> PROM error completion			
XnC	Prohibited to use	Prohibited to use	○	
XnD	E <sup>2</sup> PROM erasure normal completion	Prohibited to use	△	Delete the sequence program of the section corresponding to the function, and set parameters with GX Works2/GX Developer or with dedicated instruction (RLPASET instruction).
XnE	E <sup>2</sup> PROM erasure abnormal completion			
XnF	Module ready	Module ready	○	
X(n+1)0	Prohibited to use	Prohibited to use	○	
X(n+1)1				
X(n+1)2				
X(n+1)3				
X(n+1)4				
X(n+1)5				
X(n+1)6				
X(n+1)7				
X(n+1)8				
X(n+1)9				
X(n+1)A				
X(n+1)B				
X(n+1)C				
X(n+1)D				
X(n+1)E				
X(n+1)F				

## (b) Output signal

○ : Compatible, △ : Partial change required, × : Incompatible

Output signal	Signal name		Compat- ibility	Precautions for replacement
	AJ61QBT11/A1SJ61QBT11	QJ61BT11N		
Yn0	Refresh specification	Prohibited to use	△	Refreshed automatically. Delete the sequence program of the section corresponding to the function.
Yn1	Prohibited to use	Prohibited to use	○	
Yn2				
Yn3				
Yn4	Module reset request	Prohibited to use	×	Delete the sequence program of the section corresponding to the function. When the switch setting is changed, turn the power supply of programmable controller system OFF → ON or reset the programmable controller CPU.
Yn5	Prohibited to use	Prohibited to use	○	
Yn6	Data link startup request from buffer memory parameters	Prohibited to use	△	Delete the sequence program of the section corresponding to the function, and set parameters with GX Works2/GX Developer or with dedicated instruction (RLPASET instruction).
Yn7	Prohibited to use	Prohibited to use	○	
Yn8	Data link startup request from E <sup>2</sup> PROM parameters	Prohibited to use	△	Delete the sequence program of the section corresponding to the function, and set parameters with GX Works2/GX Developer or with dedicated instruction (RLPASET instruction).
Yn9	Prohibited to use	Prohibited to use	○	
YnA	Parameter registration request to E <sup>2</sup> PROM	Prohibited to use	△	Delete the sequence program of the section corresponding to the function, and set parameters with GX Works2/GX Developer or with dedicated instruction (RLPASET instruction).
YnB	Prohibited to use	Prohibited to use	○	
YnC				
YnD	E <sup>2</sup> PROM erasure request	Prohibited to use	△	Delete the sequence program of the section corresponding to the function, and set parameters with GX Works2/GX Developer or with dedicated instruction (RLPASET instruction).
YnE	Prohibited to use	Prohibited to use	○	
YnF				
Y(n+1)0				
Y(n+1)1				
Y(n+1)2				
Y(n+1)3				
Y(n+1)4				
Y(n+1)5				
Y(n+1)6				
Y(n+1)7				
Y(n+1)8				
Y(n+1)9				
Y(n+1)A				
Y(n+1)B				
Y(n+1)C				
Y(n+1)D				
Y(n+1)E				
Y(n+1)F				

## 6.6.2 Buffer memory comparisons

### (1) A/Ans series

Buffer memory is divided into bank0 to bank2 on the A/Ans series, but it is one area on the Q series.

Bank is switched with ON/OFF of Y (n+1)C, Y(n+1)D.

Buffer memory address of the Q series is shown in parenthesis, as buffer memory addresses of communication buffer and automatic updating buffer are different.

○ : Compatible, △: Partial change required, × : Incompatible

Bank	Buffer memory address		Buffer memory name		Compat- ibility	Precautions for replacement
	Hex.	Dec.	AJ61BT11/A1SJ61BT11	QJ61BT11N		
0	0H to 5FH	0 to 95	Parameter information area	Parameter information area	○	
	60H to 7FH	96 to 127	Prohibited to use	Prohibited to use	○	
	80H to CDH	128 to 205	Parameter information area	Parameter information area	○	
	CEH to DFH	206 to 223	Prohibited to use	Parameter information area	△	Added with the remote net Ver.2 mode. Replacement is not applied.
	E0H to 15FH	224 to 351	Remote input (RX)	Remote input (RX)	○	
	160H to 1DFH	352 to 479	Remote output (RY)	Remote output (RY)	○	
	1E0H to 2DFH	480 to 735	Remote register (RWw)	Remote register (RWw)	○	
	2E0H to 3DFH	736 to 991	Remote register (RWr)	Remote register (RWr)	○	
	3E0H to 5DFH	992 to 1503	Prohibited to use	Local station offset, size information	△	Added with the remote net Ver.2 mode. Replacement is not applied.
	5E0H to 5FFH	1504 to 1535	Link special relay (SB)	Link special relay (SB)	○	
	600H to 7FFH	1536 to 2047	Link special register (SW)	Link special register (SW)	○	
	800H to 9FFH	2048 to 2559	Prohibited to use	Prohibited to use	○	
A00H to FFFH	2560 to 4095	Random access buffer	Random access buffer	○		
1	0 to FFFH (1000H to 1FFFH)	0 to 4095 (4096 to 8191)	Communication buffer	Communication buffer	△	Delete the program for bank switching.
2	0 to FFFH (2000H to 2FFFH)	0 to 4095 (8192 to 12287)	Automatic updating buffer	Automatic updating buffer	△	Delete the program for bank switching.
-	- (3000H to 3FFFH)	- (12288 to 16383)	-	Prohibited to use	-	
-	- (4000H to 53FFFH)	- (16384 to 21503)		Area for Ver.2	△	The function was added to Q series modules.
-	- (5400H to 7FFFH)	- (21504 to 32767)		Prohibited to use	-	

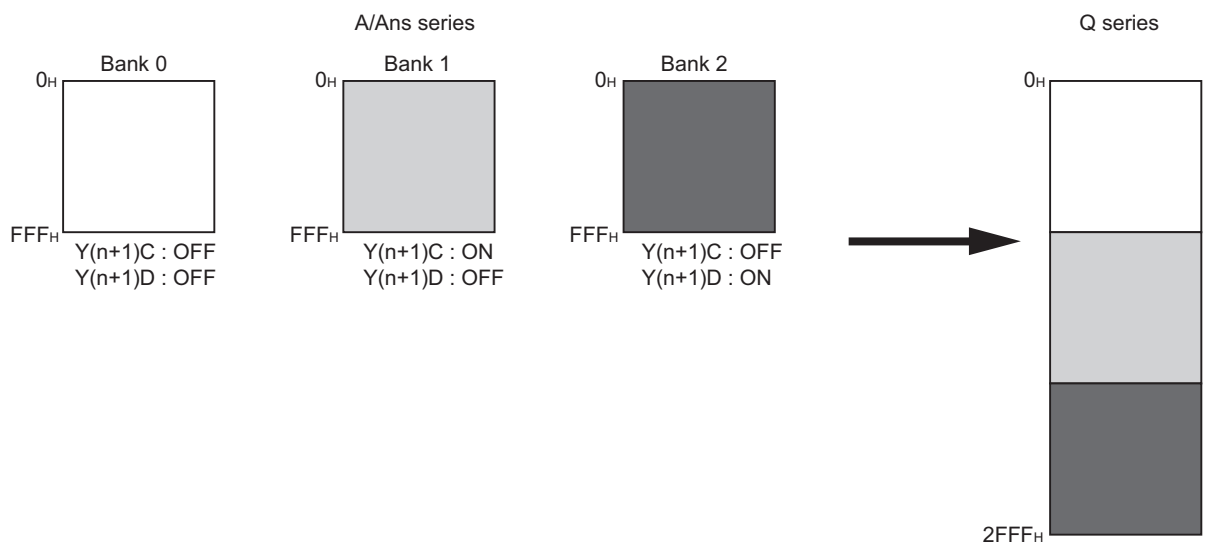

## (2) QnA/QnAS series

○ : Compatible, △ : Partial change required, × : Incompatible

Buffer memory address		Buffer memory name		Compat- ibility	Precautions for replacement
Hex.	Dec.	AJ61QBT11/ A1SJ61QBT11	QJ61BT11N		
0H to 5FH	0 to 95	Parameter information area	Parameter information area	○	
60H to 7FH	96 to 127	Prohibited to use	Prohibited to use	○	
80H to CDH	128 to 205	Parameter information area	Parameter information area	○	
CEH to DFH	206 to 223	Prohibited to use	Parameter information area	△	Added with the remote net Ver.2 mode. Replacement is not applied.
E0H to 15FH	224 to 351	Remote input (RX)	Remote input (RX)	○	
160H to 1DFH	352 to 479	Remote output (RY)	Remote output (RY)	○	
1E0H to 2DFH	480 to 735	Remote register (RWw)	Remote register (RWw)	○	
2E0H to 3DFH	736 to 991	Remote register (RWr)	Remote register (RWr)	○	
3E0H to 5DFH	992 to 1503	Prohibited to use	Local station offset, size information	△	Added with the remote net Ver.2 mode. Replacement is not applied.
5E0H to 5FFH	1504 to 1535	Link special relay (SB)	Link special relay (SB)	○	
600H to 7FFH	1536 to 2047	Link special register (SW)	Link special register (SW)	○	
800H to 9FFH	2048 to 2559	Prohibited to use	Prohibited to use	○	
A00H to FFFH	2560 to 4095	Random access buffer	Random access buffer	○	
1000H to 1FFFH	4096 to 8191	Communication buffer	Communication buffer	○	
2000H to 2FFFH	8192 to 12287	Automatic updating buffer	Automatic updating buffer	○	
- (3000H to 3FFFH)	- (12288 to 16383)	-	Prohibited to use	-	
- (4000H to 53FFH)	- (16384 to 21503)		Area for Ver.2	△	The function was added to Q series modules.
- (5400H to 7FFFH)	- (21504 to 32767)		Prohibited to use	-	

### 6.6.3 Comparison of link special relay (SB)/link special register (SW)

#### (1) A/AnS series

The following table shows SB/SW which have different application on the A series and the Q series.

#### (a) Link special relay (SB)

○ : Compatible, △: Partial change required, × : Incompatible

Number	Name		Compat- ibility	Precautions for replacement
	AJ61BT11/A1SJ61BT11	QJ61BT11N		
SB0001	Master station switching data link start	Refresh instruction at standby master switching	○	The specifications of A/AnS series and Q series are the same.
SB0003		Refresh instruction when changing parameters by the dedicated instruction	△	Use for setting network parameters with RLPASET instruction.
SB0007		Master station duplication error canceling request	△	Added on the Q series and replacement is not applied.
SB000B	-	Transmission speed test request		
SB000C		Forced master switching		
SB000D		Remote device station initialization procedure registration instruction		
SB0042	Master station switch data link start acceptance	Refresh instruction acknowledgement status at standby master switching	△	Added on the Q series and replacement is not applied.
SB0043	Master station switch data link start complete	Refresh instruction complete status at standby master switching		
SB0046	-	Forced master switching executable status		
SB004E	Parameter setting test acceptance status	Parameter information read acknowledgement status	×	The functions of A/AnS series are different from those of Q series. Since the parameter setting test function is not required for the Q series, delete the sequence program for the corresponding function.
SB004F	Parameter setting test complete status	Parameter information read completion status		
SB0057		Master station duplication error canceling acknowledgement	△	Added on the Q series and replacement is not applied.
SB0058		Master station duplication error canceling complete		
SB005A		Master switching request acknowledgement		
SB005B		Master switching request complete		
SB005C	-	Forced master switching request acknowledgement		
SB005D		Forced master switching request complete		
SB005E		Execution status of remote device station initialization procedure		
SB005F		Completion status of remote device station initialization procedure		

○ : Compatible, △ : Partial change required, × : Incompatible

Number	Name		Compat- ibility	Precautions for replacement
	AJ61BT11/A1SJ61BT11	QJ61BT11N		
SB0069	Module mode	-	△	The mode is set on the Q series using the network parameters. (The setting can be checked in SW0060.)
SB006F	-	Setting status of block guarantee of cyclic data per station	△	Added on the Q series and replacement is not applied.
SB0079	-	Master station return specification information	△	Added on the Q series and replacement is not applied.
SB007B		Host master/standby master operation status		
SB007C		Local station refresh/ compulsory clear setting status in case of programmable controller CPU STOP		
SB00B4		Standby master station test result		
SB0184		Transmission speed test result for standby master station		
SB0185		Transmission speed test accept status		
SB0186		Transmission speed test completion status		

## (b) Link special register (SW)

○ : Compatible, △ : Partial change required, × : Incompatible

Number	Name		Compat- ibility	Precautions for replacement
	AJ61BT11/A1SJ61BT11	QJ61BT11N		
SW000B	-	Dedicated instruction retry count setting	△	Added on the Q series and replacement is not applied.
SW0014 to SW0017		Specification of remote device station to be initialized.		
SW0043	Master station switch data link start result	Refresh instruction at standby master switching result	○	The specifications of A/AnS series and Q series are the same.
SW0052	-	Automatic CC-Link startup execution result	△	Added on the Q series and replacement is not applied.
SW0058		Detailed LED display status		
SW0059		Transmission rate setting		
SW005D		Forced master switching instruction result		
SW005F		Remote device station initialization procedure registration instruction result		
SW0062	Condition setting switch status	Module operating status	△	On the Q series, parameter setting status is stored.
SW00B9	E <sup>2</sup> PROM registration status	-	△	No E <sup>2</sup> PROM (Refer to Section 6.7.)
SW00BA	E <sup>2</sup> PROM erasure result			
SW00BB	Number of times when parameters can be registered to E <sup>2</sup> PROM			
SW0110 to SW011F	-	Remote device station initialization procedure registration execution individual information (target 1 to 16)	△	Added on the Q series and replacement is not applied.
SW0140 to SW0143		Compatible CC-Link Ver. information		
SW0144 to SW0147		CC-Link Ver. installation/parameter matching status		
SW0148		Parameter mode		
SW0149		Host parameter mode		
SW0183		Transmission speed test result		
SW0184 to SW0187		Transmission speed test result for each station		

## (2) QnA/QnAS series

The following table shows SB/SW that have different applications on the QnA/QnAS series and the Q series.

## (a) Link special relay (SB)

○ : Compatible, △ : Partial change required, × : Incompatible

Number	Name		Compat- ibility	Precautions for replacement
	AJ61QBT11/A1SJ61QBT11	QJ61BT11N		
SB0001	Master station switching data link start	Refresh instruction at standby master switching	○	The specifications of A/AnS series and Q series are the same.
SB0003	-	Refresh instruction when changing parameters by the dedicated instruction	△	Added on the Q series and replacement is not applied.
SB0007		Master station duplication error canceling request		
SB000B		Transmission speed test request		
SB000C		Forced master switching		
SB000D		Remote device station initialization procedure registration instruction		
SB0030	Communication command (1) acceptance	-	△	Not used on the Q series. Delete the sequence program of the section corresponding to the function, and replace READ, WRITE instructions with RIRD, RIWT instructions.
SB0031	Communication command (1) complete			
SB0032	Communication command (2) acceptance			
SB0033	Communication command (2) complete			
SB0046	-	Forced master switching executable status	△	Added on the Q series and replacement is not applied.
SB0057		Master station duplication error canceling acknowledgement		
SB0058		Master station duplication error canceling complete		
SB005A		Master switching request acknowledgement		
SB005B		Master switching request complete		
SB005C		Forced master switching request acknowledgement		
SB005D		Forced master switching request complete		
SB005E		Execution status of remote device station initialization procedure		
SB005F		Completion status of remote device station initialization procedure		

(To next page)



○ : Compatible, △ : Partial change required, × : Incompatible

Number	Name		Compat- ibility	Precautions for replacement
	AJ61QBT11/A1SJ61QBT11	QJ61BT11N		
SB0069	Module mode	-	△	The mode is set on the Q series using the network parameters. (The setting can be checked in SW0060.)
SB006F	-	Setting status of block guarantee of cyclic data per station	△	Added on the Q series and replacement is not applied.
SB0079		Master station return specification information		
SB007B		Host master/standby master operation status		
SB007C		Local station refresh/ compulsory clear setting status in case of programmable controller CPU STOP		
SB00A0	RECV instruction (1) execution request flag	-	△	Not used on the Q series. Delete the sequence program of the section corresponding to the function.
SB00A1	RECV instruction (2) execution request flag			
SB00B4	-	Standby master station test result	△	Added on the Q series and replacement is not applied.
SB0184		Transmission speed test result for standby master station		
SB0185		Transmission speed test accept status		
SB0186		Transmission speed test completion status		

## (b) Link special register (SW)

○ : Compatible, △ : Partial change required, × : Incompatible

Number	Name		Compat- ibility	Precautions for replacement
	AJ61QBT11/A1SJ61QBT11	QJ61BT11N		
SW000B	-	Dedicated instruction retry count setting	△	Added on the Q series and replacement is not applied.
SW0014 to SW0017		Specification of remote device station to be initialized.		
SW0052		Automatic CC-Link startup execution result		
SW0058		Detailed LED display status		
SW0059		Transmission rate setting		
SW005D		Forced master switching instruction result		
SW005F		Remote device station initialization procedure registration instruction result		
SW0062		Condition setting switch status		
SW00B9	E <sup>2</sup> PROM registration status	-	△	No E <sup>2</sup> PROM (Refer to Section 6.7.)
SW00BA	E <sup>2</sup> PROM erasure result		△	
SW00BB	Number of times when parameters can be registered to E <sup>2</sup> PROM		△	
SW0110 to SW011F	-	Remote device station initialization procedure registration execution individual information (target 1 to 16)	△	Added on the Q series and replacement is not applied.
SW0140 to SW0143		Compatible CC-Link Ver. information		
SW0144 to SW0147		CC-Link Ver. installation/parameter matching status		
SW0148		Parameter mode		
SW0149		Host parameter mode		
SW0183		Transmission speed test result		
SW0184 to SW0187		Transmission speed test result for each station		

## 6.7 Other Precautions

This section describes other precautions.

### (1) Peripheral device connection module

When AJ65BT-G4 type peripheral connection module is used on the A/AnS/QnA/QnAS series, replace it with AJ65BT-G4-S3 type peripheral connection module.

AJ65BT-G4 type peripheral connection module cannot be used on the Q series.

### (2) Processing time

The link scan time and link refresh time differ between the A/AnS/QnA/QnAS series and the Q series. For details on processing times, refer to the manual for the respective module.

### (3) Parameter registration to E<sup>2</sup>PROM

As the Q series CC-Link system master/local module does not have E<sup>2</sup>PROM, delete the sequence program of the section corresponding to the parameter registration to E<sup>2</sup>PROM.

On the Q series CC-Link system master/local module, set the GX Works2 or GX Developer network parameters to register parameters to the programmable controller CPU.

## 6.8 Parameter Setting Example

The following describes an example how to replace the system in which parameters were set using sequence program (TO instruction) on the A/AnS series with the system in which parameters are set using GX Works2 or GX Developer on the Q series.

This section explains the above using the following system configuration example.

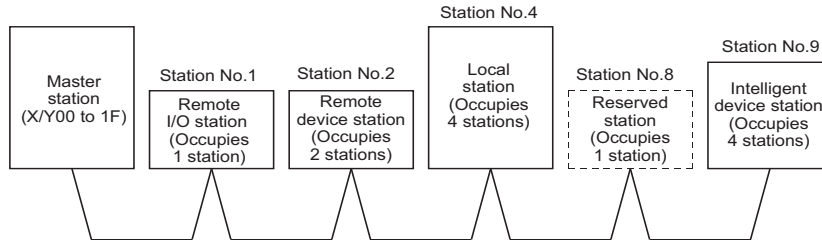

### 6.8.1 Parameter setting example on the A/AnS series

The following shows a program example of parameter setting using the sequence program (TO instruction).

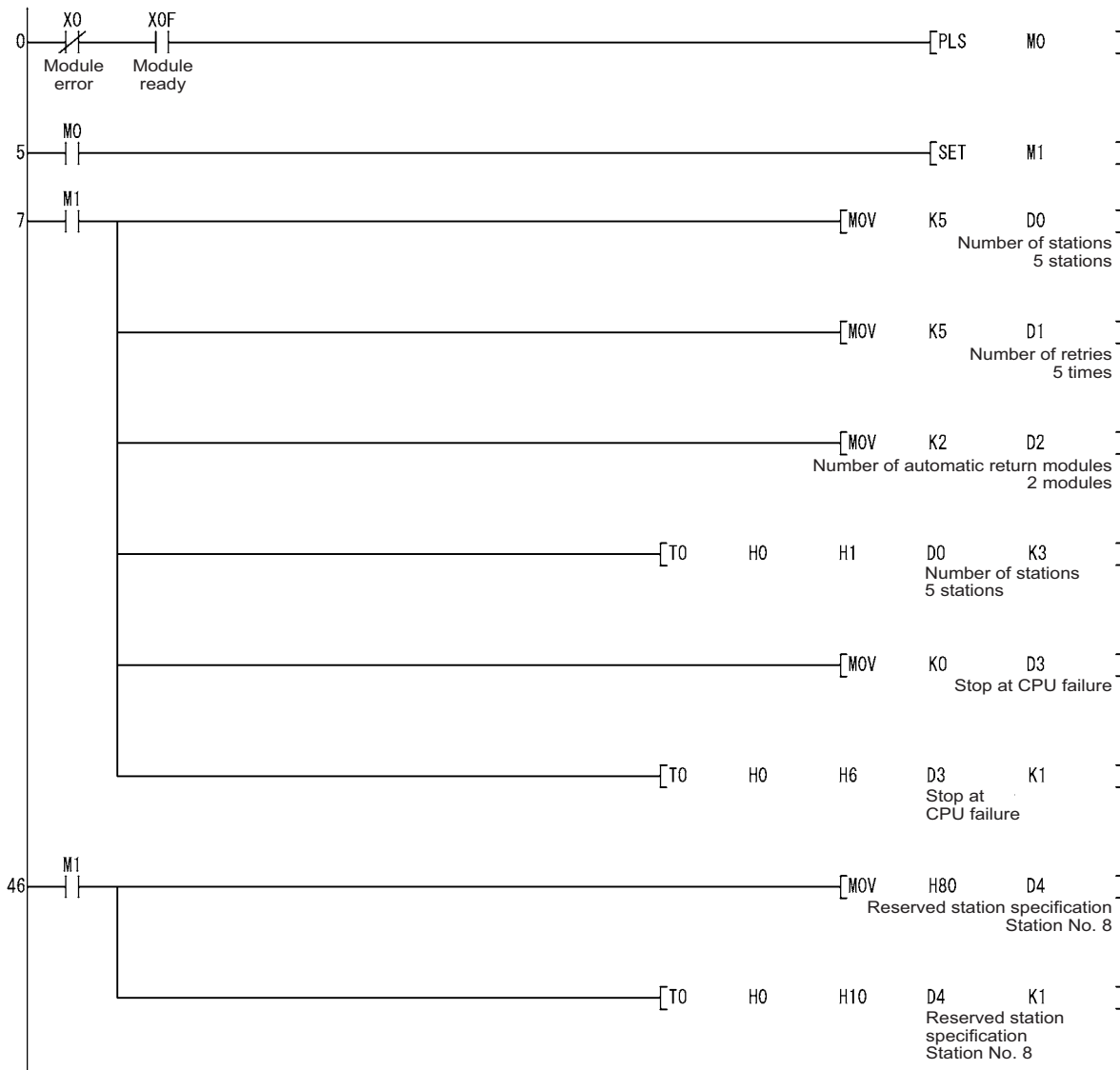

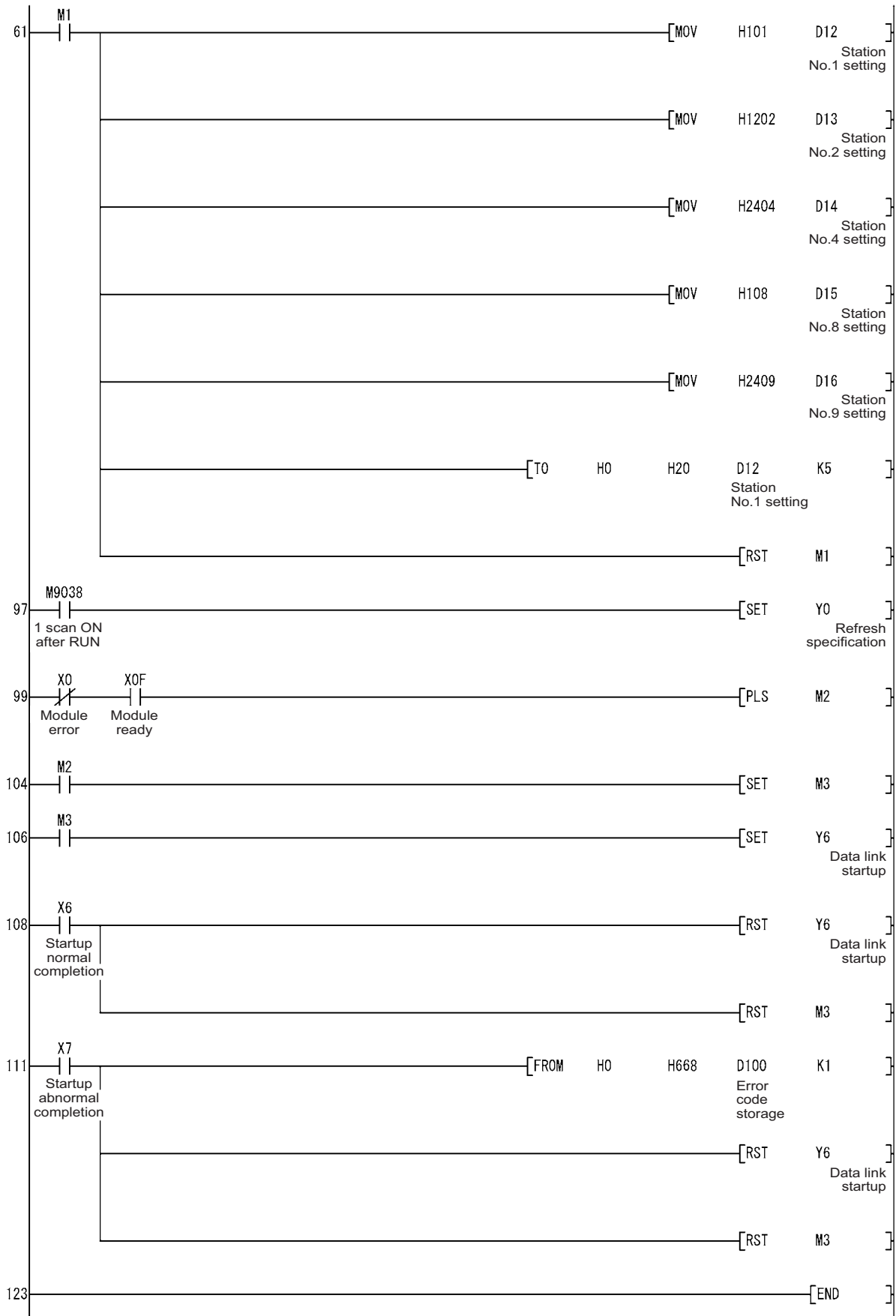

### 6.8.2 Parameter setting example on the Q series

The following shows an example of parameter setting using GX Works2.

Number of Modules:  Boards    Blank : No Setting     Set the station information in the CC-Link configuration window

	1	2	3	4
Start I/O No.	0000			
Operation Setting	Operation Setting			
Type	Master Station			
Master Station Data Link Type	PLC Parameter Auto Start			
Mode	Remote Net(Ver.1 Mode)			
Total Module Connected	5			
Remote input(RX)				
Remote output(RY)				
Remote register(RWr)				
Remote register(RWw)				
Ver.2 Remote input(RX)				
Ver.2 Remote output(RY)				
Ver.2 Remote register(RWr)				
Ver.2 Remote register(RWw)				
Special relay(SB)				
Special register(SW)				
Retry Count	5			
Automatic Reconnection Station Count	2			
Standby Master Station No.				
PLC Down Select	Stop			
Scan Mode Setting	Asynchronous			
Delay Time Setting	0			
Station Information Setting	Station Information			
Remote Device Station Initial Setting	Initial Setting			
Interrupt Settings	Interrupt Settings			

Station No.	Station Type	Expanded Cyclic Setting	Number of Occupied Stations	Remote Station Points	Reserve/Invalid Station Select	Intelligent Buffer Select(Word)		
						Send	Receive	Automatic
1/ 1	Remote I/O Station	Single	Occupied Station 1	32Points	No Setting			
2/ 2	Remote Device Station	Single	Occupied Stations 2	64Points	No Setting			
3/ 4	Intelligent Device Station	Single	Occupied Stations 4	128Points	No Setting	64	64	128
4/ 8	Remote I/O Station	Single	Occupied Station 1	32Points	Reserved Station			
5/ 9	Intelligent Device Station	Single	Occupied Stations 4	128Points	No Setting	64	64	128

## APPENDICES

### Appendix 1 External Dimensions

For external dimensions of modules shown in this handbook, refer to the user's manual for each module.

### Appendix 2 Spare parts storage

- (1) The general specifications of programmable controllers are as follows. Please do not store spare parts under a high temperature or high humidity condition, even within the range guaranteed by the specifications.

Storage ambient temperature	-20 to 75°C
Storage ambient humidity	10 to 90%, no condensation

- (2) Store in a place avoiding direct sunlight.
- (3) Store under a condition with no dust or corrosive gas.
- (4) The capacity of the batteries (such as an A6BAT battery and an A8BAT battery) or a lithium-coin battery (commercially available) for memory card is decreased by its self-discharging even when it is not used. Replace it with new one in 5 years as a guideline.
- (5) For a power supply module, CPU module with built-in power supply, or analog module that uses any aluminum electrolytic capacitor, which is indicated in the table below, take the following measures since the characteristics will be deteriorated when the aluminum electrolytic capacitor is left un-energized for a long time.

Product	Model
CPU module (Power supply built-in type)	A1NCPUR21, A1NCPUP21, A1NCPUP21-S3, A2CCPUR21, A2CCPUP21, A2CCPUC24, A2CCPUC24-PRF
	A2CJCPU-S3
	A1SJHCPU
	A61P, A61PEU, A61P-UL, A62P, A62PEU, A63P, A68P, A61RP, A67RP
Power supply module	A2CJ66P
	A1S61PN, A1S62PN, A1S63P
Analog module	A62DA, A62DA-S1
	A1S64AD, A1S68AD, A1S62DA, A1S68DAI, A1S68DAV,
	A1S63ADA, A1S66ADA

[Countermeasures for preventing aluminum electrolytic capacitor characteristics deterioration]

Apply the rated voltage to the aluminum electrolytic capacitor for several hours to activate it. Or, rotate products at the periodic inspection (in every 1 to 2 years).

[Reference]

The life of an aluminum electrolytic capacitor, even if not used, under a normal temperature decreases approximately at 1/4 speed of the case when it is energized.



## Appendix 3 Replacement using spare parts

This section describes replacement methods using spare parts of discontinued models.

### Appendix 3.1 Replacement using A/AnS/QnA/QnAS series MELSECNET/10 network modules

Notice	A/QnA series MELSECNET/10 network modules have been discontinued at the end of September 2014. AnS/QnAS series MELSECNET/10 network modules have been discontinued at the end of March 2019. For details, refer to the technical bulletins (FA-A-0141 and FA-A-0260).
--------	---

When adding QCPU to the existing MELSECNET(II) network system or replacing some programmable controller CPUs in the system with QCPUs, data will be shared by installing a gateway station, which relays cyclic communication data, between MELSECNET/10 and MELSECNET(II).

This chapter describes the method to perform cyclic communication data relay between the existing MELSECNET(II) network system and the new MELSECNET/10 network system using a gateway set.

#### (1) Application of gateway station

A gateway station exchanges the link data between MELSECNET(II) and MELSECNET/10.

##### (a) Adding QCPU to the existing MELSECNET(II) network system

(Example)

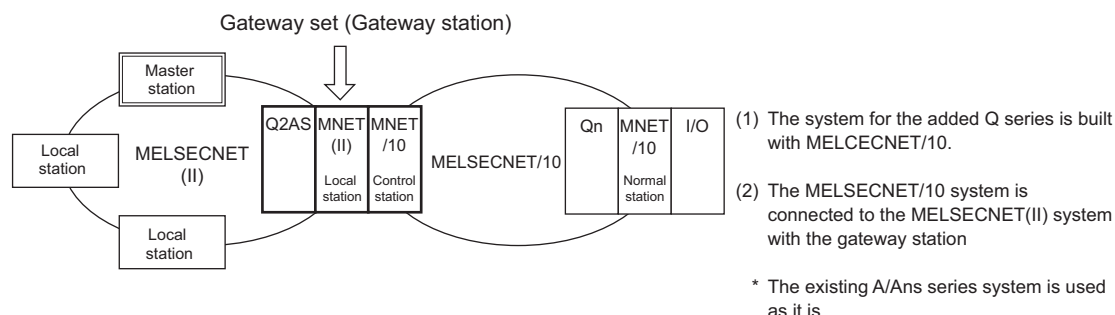
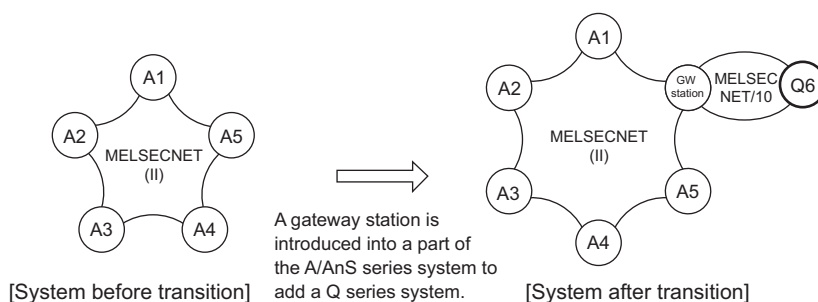

Since QCPUs are incompatible with MELSECNET(II), the network system is built in MELSECNET/10 by adding a gateway station to the existing MELSECNET(II) network system.

The gateway station passes and shares the link data between MELSECNET(II) and MELSECNET/10 by inter-link data transfer parameter or sequence program.

**(b) Replacing CPU in existing MELSECNET(II) with QCPU in stages**

(Example)

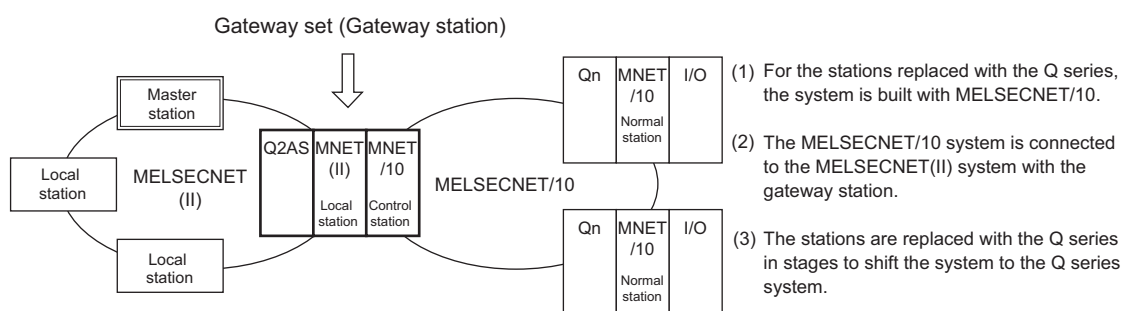
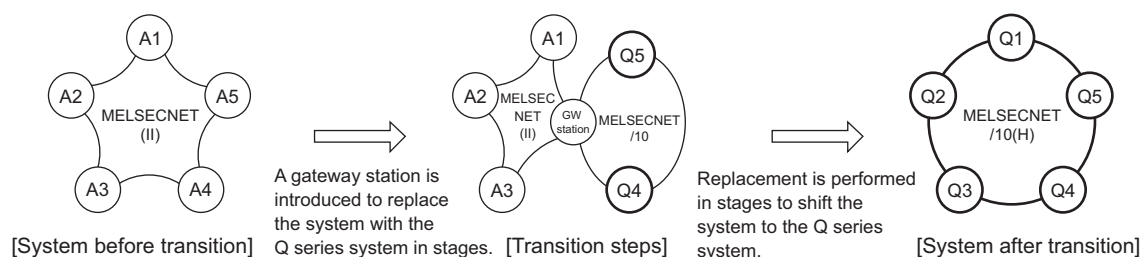

The system is shifted to the MELSECNET/H(10) network system by replacing A/AnS/QnA/QnASCPUs in the existing MELSECNET(II) network system with QCPUs in stages until all CPUs are replaced by QCPUs.

When the existing network is the remote I/O network or the network comprising local stations and remote I/O stations, the remote I/O stations must be replaced all at once.

Mount two modules for PLC to PLC network control station or normal station and remote I/O network master station to the replaced QCPU, and then replace remote I/O stations all at once.

**☒ Point**

- (1) Parameter settings when the gateway station CPU does not have a control program  
When data transmission/reception between the gateway station CPU and network module is not necessary, data can be relayed only by setting network parameters and inter-link data transfer parameters. (Refer to Appendix 3.1 (4))
- (2) Parameter settings when the cyclic transmission data is read to the gateway station CPU  
When the cyclic transmission data is read to the gateway station CPU, the network parameter and inter-link data transfer parameter, depending on the setting contents, sometimes do not match with the link refresh parameter. In this case, perform cyclic transmission data relay between MELSECNET(II) and MELSECNET/10 by sequence program. (Refer to Appendix 3.1 (5))
- (3) Number of B/W points assigned to one station  
Maximum points can be relayed are 1k bytes (first half)/1k bytes (second half) for MELSECNET(II) and 2000 bytes for MELSECNET/10. For this reason, cyclic data of entire network may not be relayed. It is necessary to narrow down the range of cyclic data to be relayed by setting priorities.

## (2) List of A/AnS/QnA/QnAS series MELSECNET/10 network modules

For A/AnS/QnA/QnAS series MELSECNET/10 network modules which can be used as a gateway station, refer to Section 4.1.

## (3) Precautions using a gateway station

### (a) Link data and function

The following shows link data and function.

Item	Detailed description
Number of link data*1	MELSECNET(II) to MELSECNET/10: 2000 bytes
	MELSECNET/10 to MELSECNET(II): first half 1024 bytes, second half 1024 bytes
Link data	Cyclic data (LB/LW)
	(Cyclic data (LX/LY), link special relay/register, and transient transmission cannot be relayed.)
Network diagnostics*2	Diagnostics are required in the MELSECNET(II) and MELSECNET/10 respectively.

\*1 The number of B/W points assigned to one station is limited.

Since all data cannot be relayed, narrow down the data to be relayed by setting priorities.

\*2 Both network diagnostics can be performed by connecting GX Developer to the gateway station.

### (b) Cyclic data transmission delay

Transmission delay shall be the time that relay processing delay time is added to each cyclic transmission delay time in the MELSECNET(II) system and the MELSECNET/10 system.

Confirm that the delay does not affect the control on modules.

### (c) Restrictions on system configuration

- Set the MELSECNET(II) side of gateway station as local station in the second tier.  
According to the MELSECNET(II) specifications, local station cannot be mounted as a gateway station on one CPU because of the local station in the second tier and master station for the third tier combination restriction.  
When the existing master station is AnU/AnUS(H)CPU or QnA/QnASCPU and the MELSECNET/10 module is added as a gateway station with the existing MELSECNET(II) configured as is, there are no restrictions.
- At the gateway station, elongation and variation of the scan time may occur due to link refreshes of both MELSECNET(II) and MELSECNET/10.  
It is recommended that the gateway station only shall relay the link data and avoid control program.

#### [Common precautions]

- For a relay station, use the AnU/AnUS(H)/QnA/QnASCPU that supports MELSECNET(II) and MELSECNET/10 modules.  
Modules other than those cannot serve as a relay station.
- Due to link refresh among the CPU module, MELSECNET(II) module, and MELSECNET/10 module on the relay station, the scan time may be delayed or varied.  
Using the CPU module only for link refresh processing is recommended.

#### (4) Communications between existing ACPU (MELSECNET(II)) and added QCPU (MELSECNET/10) (Inter-link data transfer)

This section describes the method to perform data transmission/reception between existing A/AnSCPU in MELSECNET(II) and added QCPU by inter-link data transfer using a gateway station.

##### (a) System configuration example

###### 1) Configuration of the existing MELSECNET(II)

An example of the existing system configuration is as follows: master station (M: A3ACPU), local station 1 (L1: A2ACPU), and local station 2 (L2: A1SHCPU).

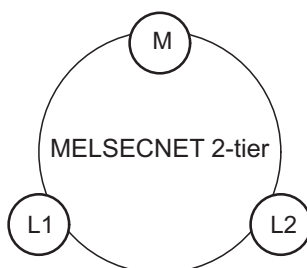

###### 2) Configuration after QCPU addition

By newly adding the gateway station (Q2ASCPU: L3/1Mp1) to the above configuration 1) and connecting it to the QCPU (1Ns2) in MELSECNET/10, link data relay is performed between MELSECNET(II) and MELSECNET/10.

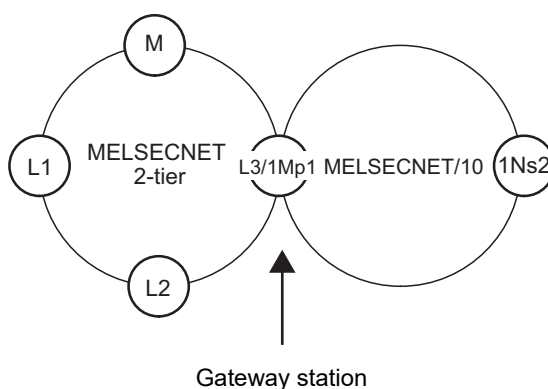

**(b) Network range assignment for MELSECNET(II)**

**1) Existing B/W network range assignment**

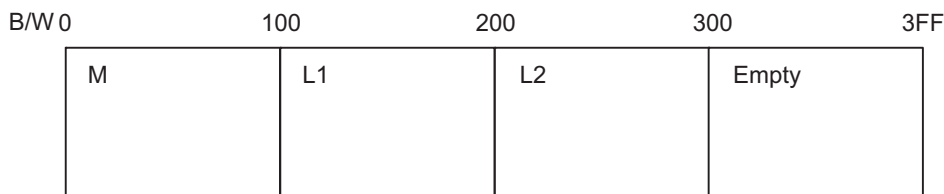

**2) B/W network range assignment after addition of the gateway station (L3/1Mp1)**

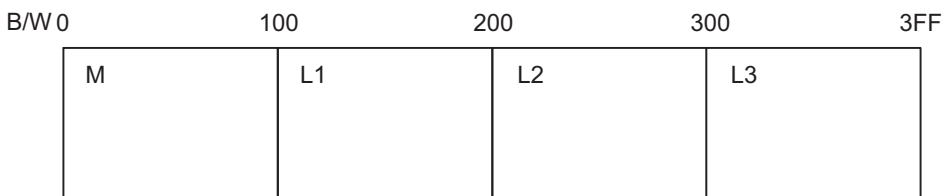

MELSECNET/10 data receiving area  
by inter-link data transfer

When the data is transferred from MELSECNET/10 to MELSECNET(II), B/W300 to 3FF shall be the transfer area.

**(c) Network range assignment for MELSECNET/10**

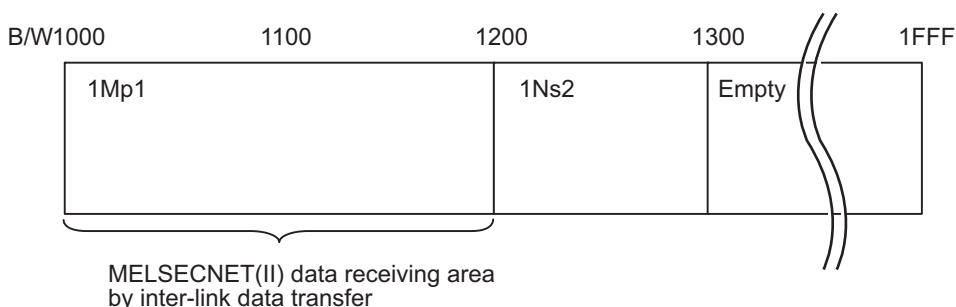

When the data is transferred from MELSECNET(II) to MELSECNET/10, B/W1000 to 11FF shall be the transfer area.

Since all points cannot be transferred from MELSECNET(II) to MELSECNET/10, narrow down the data to be relayed by setting priorities.

Set the data to be transferred at the inter-link data transfer.

(d) Example of inter-link data transfer

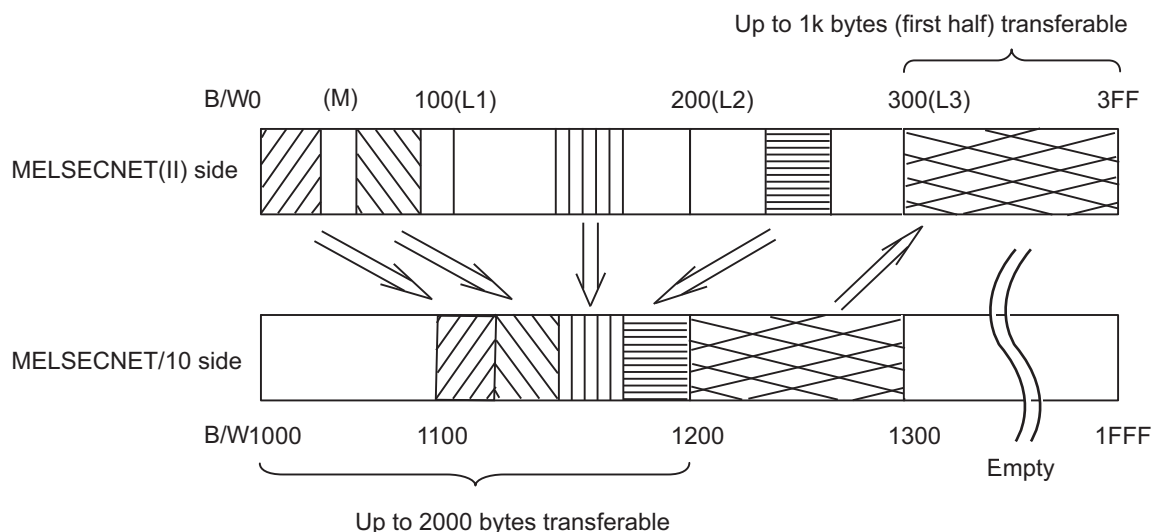

(e) Network parameter settings

1) MELSECNET master station

The following shows the network parameter settings of the MELSECNET master station (A3ACPU).

• Network parameter settings (A3ACPU: MELSECNET master station)

	Module No.1	Module No.2	Module No.3	Module No.4
Network type	MNET(Master station)	None	None	None
Start I/O No.				
Network No.				
Total stations	3			
Group No.				
Station No.				
	Network range assignment			

Necessary setting[ No setting / Already set ] Set if it is needed[ No setting / Already set ]

Start I/O No.:  Valid module during other station access

Interlink transmission parameters: Input the start I/O No. installed in the module in 16-point unit.

Buttons: Acknowledge XY assignment, Routing parameters, Check, End, Cancel

• Network range assignment LB/LW settings (A3ACPU: MELSECNET master station)

Setup common parameters

Assignment method:  Points/Start  Start/End

Monitoring time:  × 10ms

Total slave stations:  Switch screens:

L/R station No.	Send range for each station			Send range for each station			M station → R station			M station ← R station		
	Points	Start	End	Points	Start	End	LW			LW		
M 0	256	0000	00FF	256	0000	00FF						
L 1	256	0100	01FF	256	0100	01FF						
L 2	256	0200	02FF	256	0200	02FF						
L 3	256	0300	03FF	256	0300	03FF						

## 2) Gateway station (Q2ASCPU: L3/1Mp1)

The following shows the network parameter settings of the gateway station (Q2ASCPU: L3/1Mp1).

### • Network parameter settings (Q2ASCPU: L3/1Mp1)

	Module No.1	Module No.2	Module No.3	Module No.4
Network type	MNET (Local station)	MNET/10(Controlling station)	None	None
Start I/O No.	0000	0020		
Network No.		1		
Total stations		2		
Group No.				
Station No.				
IP addressDEC				
		Network range assignment		
	Refresh parameters	Refresh parameters		

Necessary setting( No setting / Already set ) Set if it is needed( No setting / Already set )

Start I/O No.: Input the start I/O No. installed in the module in 16-point unit. Valid module during other station access 1

Interlink transmission parameters

Acknowledge XY assignment Routing parameters Check End Cancel

### • Network range assignment BW settings (Q2ASCPU: L3/1Mp1)

Setup common and station inherent parameters.

Assignment method  
 Points/Start  
 Start/End

Monitoring time 200 × 10ms  
 Total slave stations 2  
 Parameter name  
 Switch screens BW setting

StationNo.	Send range for each station B			Send range for each station W								
	Points	Start	End	Points	Start	End	Points	Start	End	Points	Start	End
1	512	1000	11FF	512	1000	11FF						
2	256	1200	12FF	256	1200	12FF						

### • Module 1 (MNET local station) refresh parameter

Assignment method  
 Points/Start  
 Start/End

Transient transmission error history status  
 Overwrite  Hold

	Link side				PLC side		
	Points	Start	End		Points	Start	End
B transmission				↕			
W transmission				↕			
X/Y transmission		0000		↕			

### 3) Module 2 (MNET/10 control station) refresh parameter

Assignment method  
 Points/Start  
 Start/End

Transient transmission error history status  
 Overwrite  Hold

	Link side				PLC side		
	Points	Start	End		Points	Start	End
B transmission				↕			
W transmission				↕			
X transmission				↕			
Y transmission				↕			

### 4) Inter-link data transfer module 1

Since all points cannot be transferred from MELSECNET(II) to MELSECNET/10, narrow down the data to be relayed by setting priorities.

Assignment method  
 Points/Start  
 Start/End

Module 1 -> 2 | Module 2 -> 1

No.	B						W					
	Transfer from			Transfer to			Transfer from			Transfer to		
	MNET (Local station)			MNET/10(Controlling station)			MNET (Local station)			MNET/10(Controlling station)		
	Points	Start	End	Points	Start	End	Points	Start	End	Points	Start	End
1	128	0000	007F	128	1000	107F	128	0000	007F	128	1000	107F
2	64	00A0	00DF	64	1080	10BF	64	00A0	00DF	64	1080	10BF
3	128	0100	017F	128	10C0	113F	128	0100	017F	128	10C0	113F
4	64	01A0	01DF	64	1140	117F	64	01A0	01DF	64	1140	117F
5	128	0200	027F	128	1180	11FF	128	0200	027F	128	1180	11FF
6												
7												

#### • From MELSECNET/10 to MELSECNET(II)

Assignment method  
 Points/Start  
 Start/End

Module 1 -> 2 | Module 2 -> 1

No.	B						W					
	Transfer from			Transfer to			Transfer from			Transfer to		
	MNET/10(Controlling station)			MNET (Local station)			MNET/10(Controlling station)			MNET (Local station)		
	Points	Start	End	Points	Start	End	Points	Start	End	Points	Start	End
1	256	1200	12FF	256	0300	03FF	256	1200	12FF	256	0300	03FF
2												
3												



## (5) Communications between existing ACPU in MELSECNET(II) and added QCPU (data transmission/reception by sequence program)

This section describes the method to perform data transmission/reception between existing A/AnSCPU in MELSECNET(II) and added QCPU by sequence program using a gateway station.

This method is useful when the link refresh parameter in the inter-link data transfer cannot be set because the transmission range of MELSECNET(II) is located in the middle.

### (a) System configuration example

#### 1) Configuration of the existing MELSECNET(II)

An example of the existing system configuration is as follows: master station (M: A3ACPU), local station 1 (L1: A2ACPU), local station 2 (L2: A1SHCPU), remote I/O station 3 (R3), and remote I/O station 4 (R4).

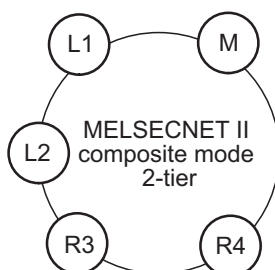

#### 2) Configuration after QCPU addition

By newly adding the gateway station (Q2ASCPU: L5/1Mp1) to the above configuration 1) and connecting it to the QCPU (1Ns2) in MELSECNET/10, link data relay is performed between MELSECNET(II) and MELSECNET/10.

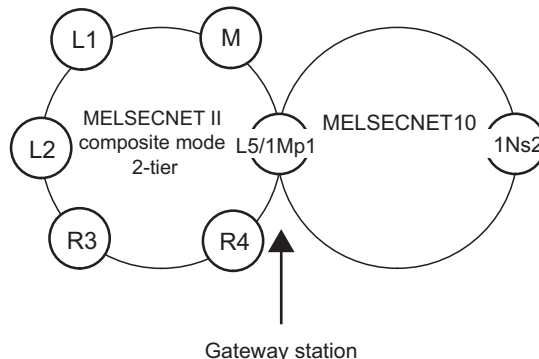

**(b) Network range assignment for MELSECNET(II)**

**1) LX/LY network range assignment**

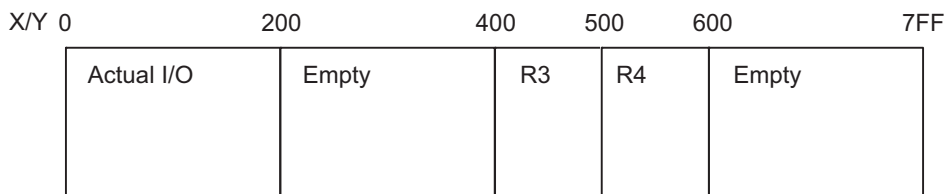

**2) BW network range assignment before addition of the gateway station (L5/1Mp1)  
(Assignment in the area of 200 to 3FF is W only.)**

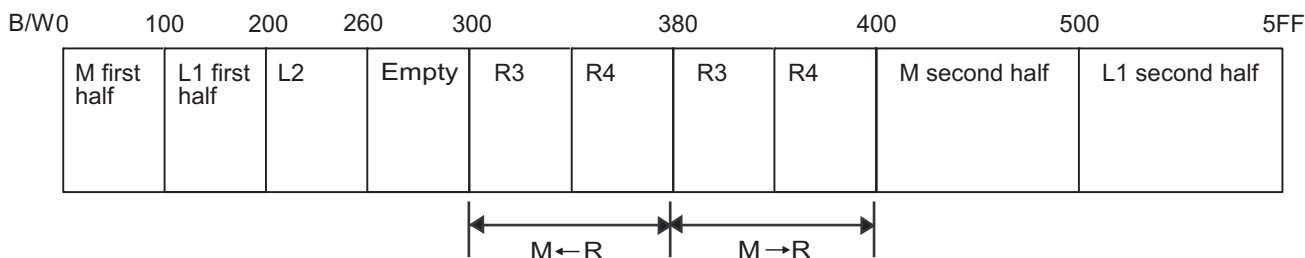

**3) BW network range assignment after addition of the gateway station (L5/1Mp1)  
(Assignment in the area of 200 to 3FF is W only.)**

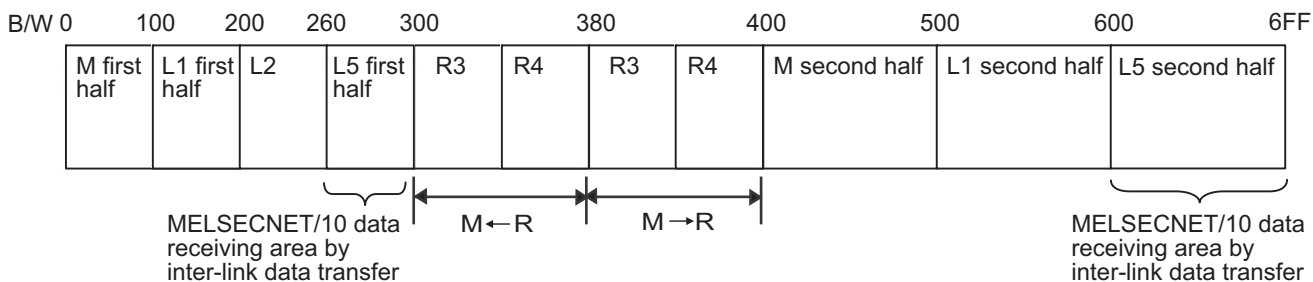

When the data is transferred from MELSECNET/10 to MELSECNET(II), B/W260 to 3FF shall be the transfer area.

Note that only the data required for QCPU(1Ns2) are transferred to MELSECNET(II).

**(c) Network range assignment for MELSECNET/10**

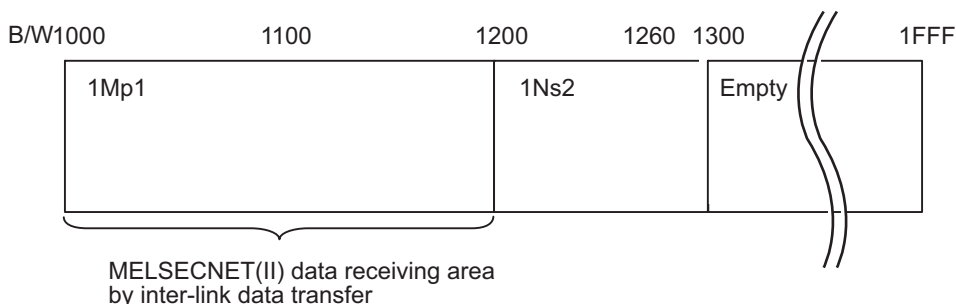

When the data is transferred from MELSECNET(II) to MELSECNET/10, B/W1000 to 11FF shall be the transfer area.

Since all points cannot be transferred from MELSECNET(II) to MELSECNET/10, narrow down the data to be transferred by setting priorities.

(d) Network parameter settings

1) MELSECNET II composite master station

The following shows the network parameter settings of the MELSECNET II composite master station (A3ACPU).

• Network parameter settings (A3ACPU: MELSECNET II composite master station)

	Module No.1	Module No.2	Module No.3	Module No.4
Network type	MNET II comp. (Master station)	None	None	None
Start I/O No.				
Network No.				
Total stations	5			
Group No.				
Station No.				
	Network range assignment			

Necessary setting( No setting / Already set ) Set if it is needed( No setting / Already set )

Start I/O No.:  Valid module during other station access

Interlink transmission parameters:  Routing parameters:

• Network range assignment LX/LY (A3ACPU: MELSECNET II composite master station)

Setup common parameters

Assignment method:  Points/Start  Start/End

Monitoring time:  × 10ms

Total slave stations:  Switch screens: LX/LY settings

L/R station No.	M station → L/R station						M station ← L/R station					
	LY			LX/LY			LX			LY/LX		
	Points	Start	End	Points	Start	End	Points	Start	End	Points	Start	End
M 0												
L 1												
L 2												
R 3	256	0400	04FF	256	0000	00FF	256	0400	04FF	256	0000	00FF
R 4	256	0500	05FF	256	0000	00FF	256	0500	05FF	256	0000	00FF
L 5												

• Network range assignment first half LB/LW settings (A3ACPU: MELSECNET II composite master station)

Setup common parameters

Assignment method:  Points/Start  Start/End

Monitoring time:  × 10ms

Total slave stations:  Switch screens: First half LB/LW setting

L/R station No.	Send range for each station			Send range for each station			M station → R station			M station ← R station		
	First half LB			First half LW			LW			LW		
	Points	Start	End	Points	Start	End	Points	Start	End	Points	Start	End
M 0	256	0000	00FF	256	0000	00FF						
L 1	256	0100	01FF	256	0100	01FF						
L 2	96	0200	025F	96	0200	025F						
R 3							64	0300	033F	64	0380	03BF
R 4							64	0340	037F	64	03C0	03FF
L 5	160	0260	02FF	160	0260	02FF						

• **Network range assignment first half LB/LW settings (A3ACPU: MELSECNET II composite master station)**

Setup common parameters

Assignment method  
 Points/Start  
 Start/End

Monitoring time  × 10ms

Total slave stations  Switch screens

L/R station No.	Send range for each station			Send range for each station								
	Points	Start	End	Points	Start	End	Points	Start	End	Points	Start	End
M 0	256	0400	04FF	256	0400	04FF						
IL 1	256	0500	05FF	256	0500	05FF						
L 2												
R 3												
R 4												
IL 5	256	0600	06FF	256	0600	06FF						

2) **Gateway station (Q2ASCPU: L5/1Mp1)**

The following shows the network parameter settings of the gateway station (Q2ASCPU: L5/1Mp1).

• **Network parameter settings (Q2ASCPU: L5/1Mp1)**

	Module No.1	Module No.2	Module No.3	Module No.4
Network type	MNET II comp. (Local station)	MNET /10(Controlling station)	None	None
Start I/O No.	0000	0020		
Network No.		1		
Total stations		2		
Group No.				
Station No.				
IP addressDEC				
		Network range assignment		
	Refresh parameters	Refresh parameters		

Necessary setting[ No setting / Already set ] Set if it is needed[ No setting / Already set ]

Start I/O No.:  Valid module during other station access:

Interlink transmission parameters

Acknowledge XY assignment

• **Network range assignment BW settings (Q2ASCPU: L5/1Mp1)**

Setup common and station inherent parameters.

Assignment method  
 Points/Start  
 Start/End

Monitoring time  × 10ms

Total slave stations  Switch screens

Parameter name

StationNo.	Send range for each station			Send range for each station								
	Points	Start	End	Points	Start	End	Points	Start	End	Points	Start	End
1	512	1000	11FF	512	1000	11FF						
2	256	1200	12FF	256	1200	12FF						

• **Module 1 (MELSECNET local station) refresh parameter**

Assignment method  
 Points/Start  
 Start/End

Transient transmission error history status  
 Overwrite  Hold

	Link side				PLC side		
	Points	Start	End		Points	Start	End
B transmission	1792	0000	06FF	↔	1792	0000	06FF
W transmission	1792	0000	06FF	↔	1792	0000	06FF
X/Y transmission	2048	0000	07FF	↔	2048	0000	07FF

• **Module 2 (MELSECNET/10 control station) refresh parameter**

Assignment method  
 Points/Start  
 Start/End

Transient transmission error history status  
 Overwrite  Hold

	Link side				PLC side		
	Points	Start	End		Points	Start	End
B transmission	768	1000	12FF	↔	768	1000	12FF
W transmission	768	1000	12FF	↔	768	1000	12FF
X transmission				↔			
Y transmission				↔			

(e) **How to transfer data**

**1) Transfer from MELSECNET(II) to MELSECNET/10**

Write the data of MELSECNET(II) into the host station range of the gateway station (1Mp1) using the BMOV instruction.

Since all points cannot be transferred from MELSECNET(II) to MELSECNET/10, narrow down the data to be relayed by setting priorities.

**2) Transfer from MELSECNET/10 to MELSECNET(II)**

Write all data of MELSECNET/10 into the host station range of the gateway station (L5) using the BMOV instruction.

Write all data to be used in the master station (M: A3ACPU), local station 1 (L1: A2ACPU), and local station 2 (L2: A1SHCPU) into the first half LB/LW of L5.

Data cannot be used in the local station 2 (L2: A1SHCPU), which is incompatible with MELSECNET II, can be transferred using the second half LB/LW of L5.

Sample program

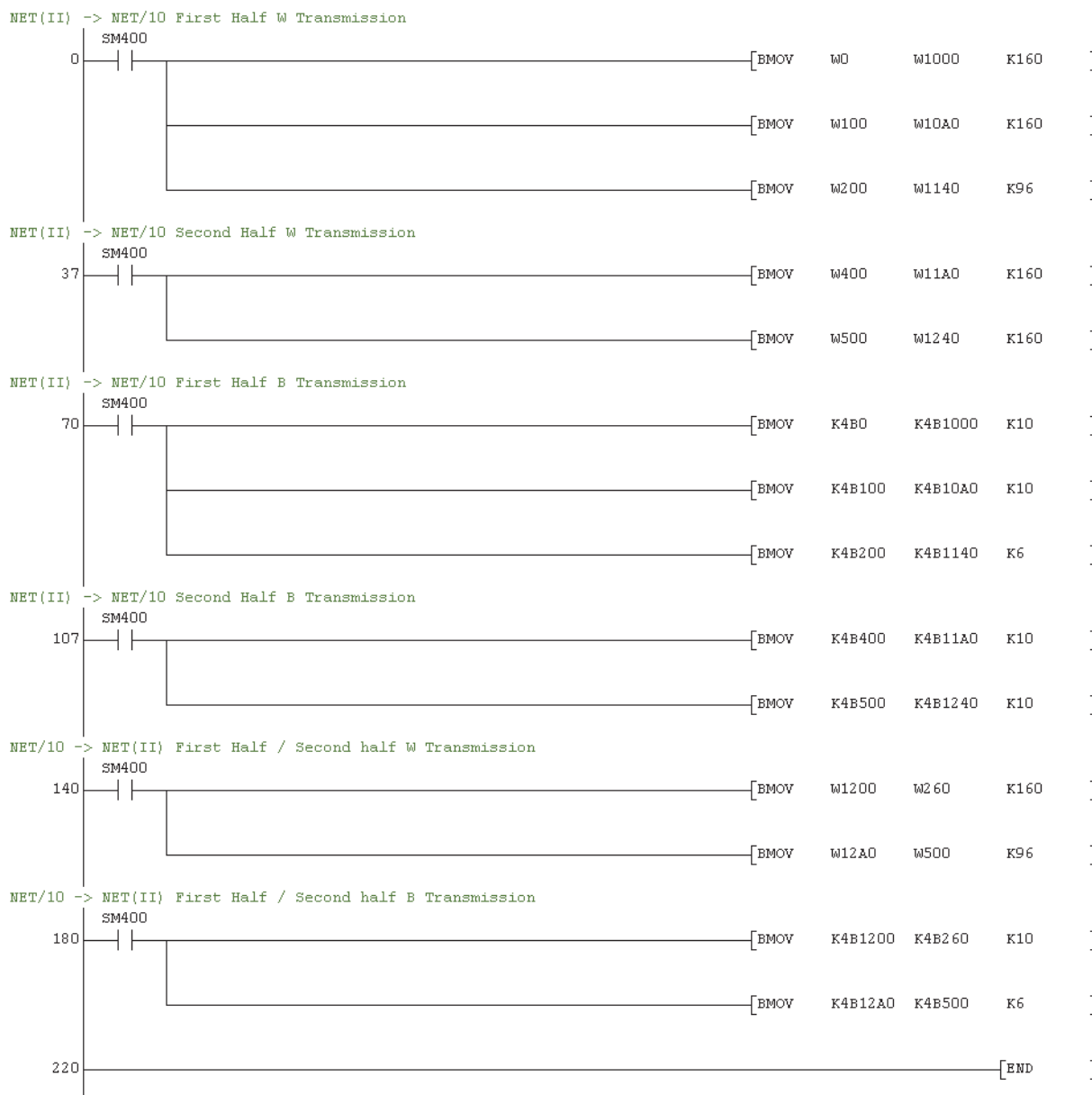

## Appendix 3.2 Replacement using MELSECNET local station data link modules

Notice	MELSECNET local station data link modules have been discontinued at the end of December 2017. For details, refer to the technical bulletin (FA-A-0249).
--------	--

### (1) Application that connects the QCPU as the local station

#### (a) Replacing a module with the QCPU without changing the existing network

(Example)

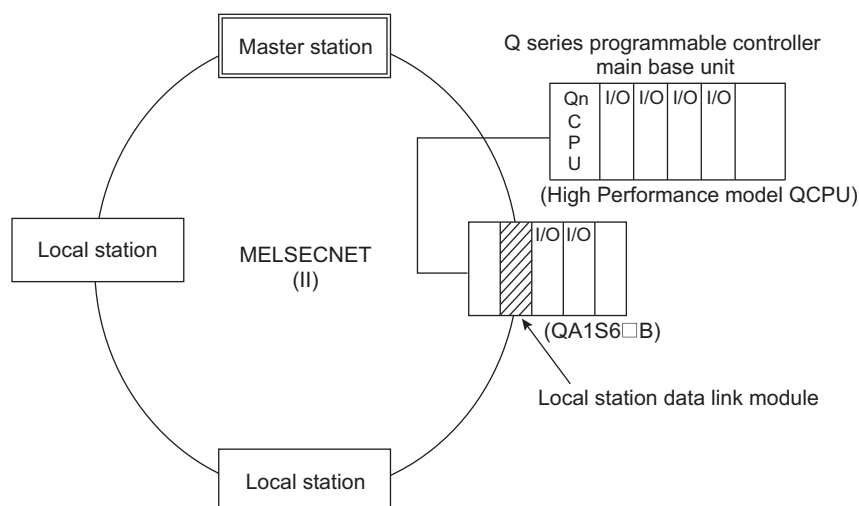
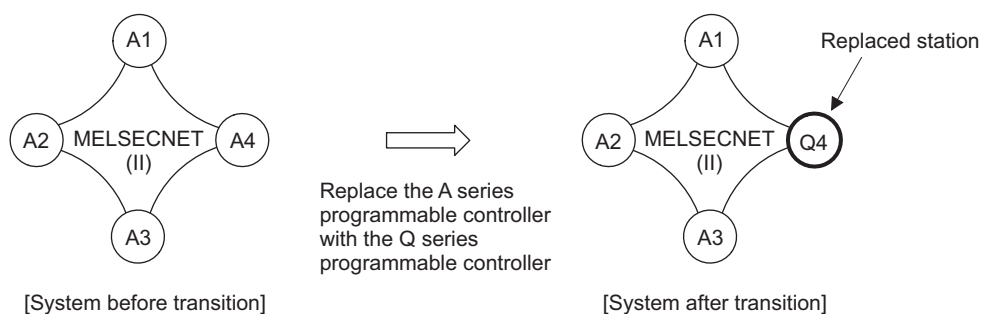

By mounting the local station data link module, the QCPU replaced by the A/AnSCPU can communicate as the local station without changing the existing network link assignment even after CPU replacement.

**(b) Adding the QCPU to the existing network**

(Example)

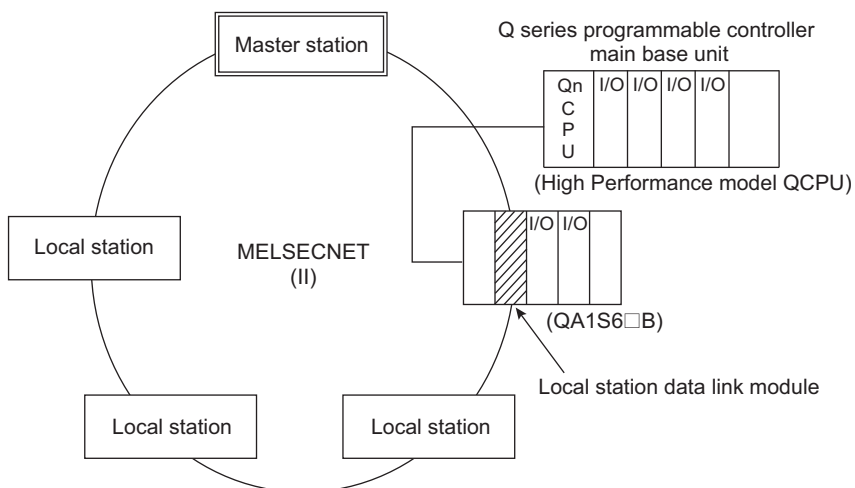
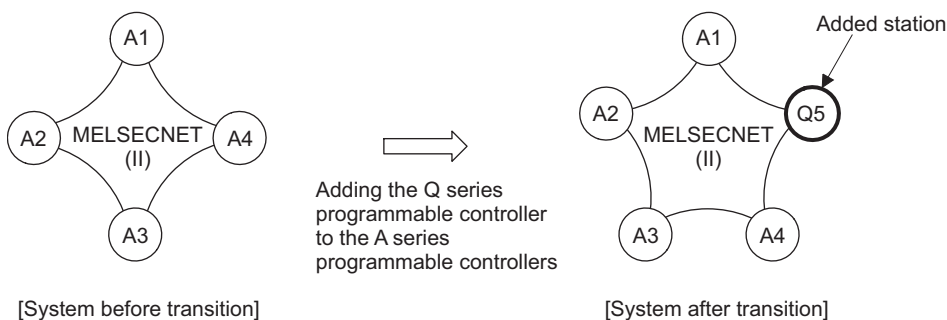

When the QCPU is added to the existing network, it can communicate as the local station using the existing network link assignment by mounting the local station data link module.



## (2) List of local station data link module

The following models are available to connect the QCPU with the existing MELSECNET(II), /B. Select a model according to the existing network system.

Model	Product name
A1SJ71AP23Q	MELSECNET(II) local station data link module for optical fiber cable (SI)
A1SJ71AR23Q	MELSECNET(II) local station data link module for coaxial cable
A1S71AT23BQ	MELSECNET/B local station data link module for shielded twisted pair cable

## (3) Precautions for using local station data link module

This section describes precautions for using the local station data link module.

### (a) Precautions for selection

When connecting the QCPU to the MELSECNET(II), /B, the existing data link module cannot be used.

Make sure to select a module from Model list in Appendix 3.2 (2).

### (b) Available CPU modules and mountable base units

For details on QCPUs where a local station data link module can be used and on mountable base units, refer to the following.

- MELSECNET, MELSECNET/B Local Station Data Link Module User's Manual

### (c) Number of mountable modules

Up to six local station data link modules can be mounted to one CPU module.

When using the module such as the AD51H, which can be mounted to the "QA1S51B", "QA1S6□B", or "QA6□B" but the number of mountable modules are restricted, the module is included in the number of local station data link modules.

### (d) Precautions for three-tier system

If the replaced station is the master station for the third tier, since the QCPU cannot be the MELSECNET(II) master station, measures such as replacing the MELSECNET/H (10) to the third tier are required.

#### (4) Network parameter

This section describes network parameter for local station data link module.

##### (a) Setting the number of MELSECNET/Ethernet cards

The local station data link module does not require network parameter setting.

After configuring the network, the module performs parameter communications with the master station, and automatically acquires information necessarily for the network such as send range assignment for each station.

##### (b) Network refresh parameter

Link refresh is not automatically performed.

Therefore, create the sequence program which sends/receives data using the FROM/TO instructions for data transfer.

For details of I/O signals for program creation and buffer memory address, refer to the following manual.

- MELSECNET, MELSECNET/B Local Station Data Link Module User's Manual

A necessary program for link refresh is offered by the "A/QnA -> Q conversion support tool" as a sample program. By integrating the sample program as the QCPU scan execution type program, creating a program becomes unnecessary. For "A/QnA to Q conversion support tool", contact your local representative.

(c) Sample program

The following shows conditions of a sample program for link refresh.

1) Condition 1 (Only for the MELSECNET mode and second tier)

- Number of mounted local station data link modules: 1
- Module mounting address: X/Y200 to 21F slot
- Network type: MELSECNET mode
- Send range for each station setting: Only first half set
- Master station for the third tier B/W receive program: None
- Program for receiving LRDP instruction: None
- Program for receiving LWDP instruction: None
- X/Y link: None
- Refresh device (bit): B00 to 3FF
- Refresh device (word): W00 to 3FF

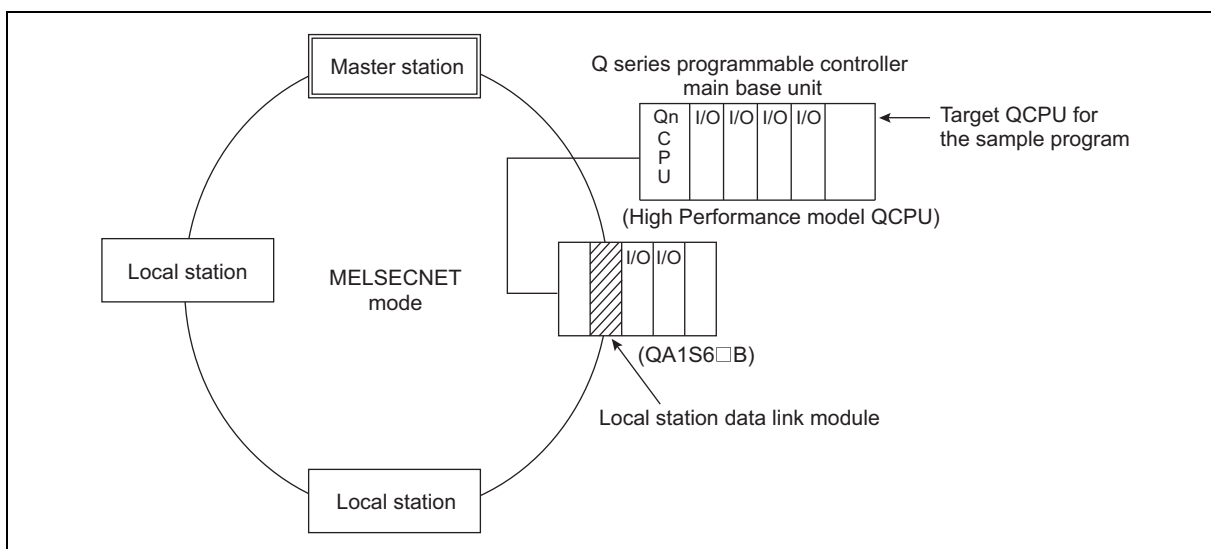

• Setting examples of the A/QnA-Q conversion support tool (Condition setting)

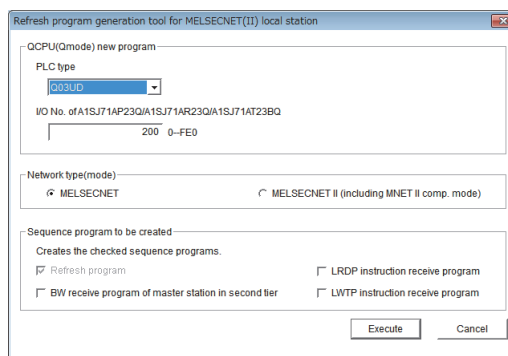

(Refresh device setting)

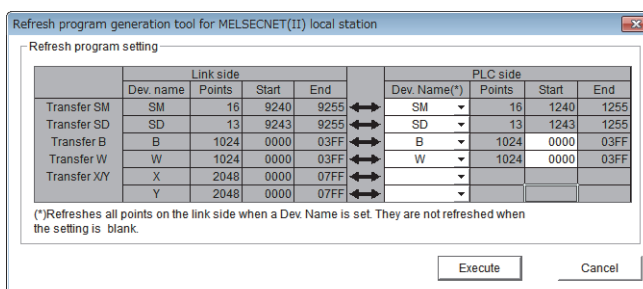

Save the relevant device data in the save area.

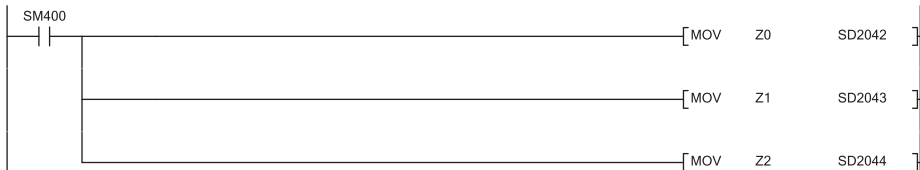

When powered ON, Initialize B/W devices.



Transfer W to the local module.  
Transfer B to the local module.

RUN status

Refresh request

In refresh ready status, start refresh.

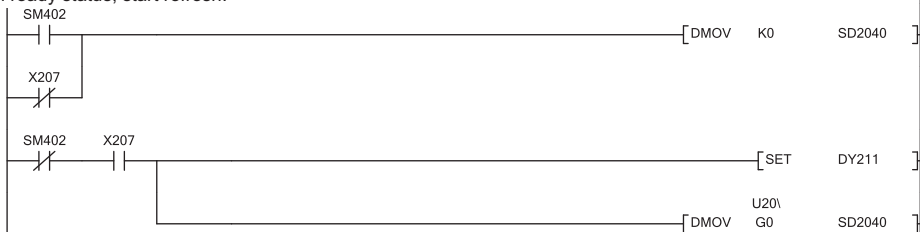

No refresh request

Refresh in execution

Obtain whether the refresh information table is present or not.

W transmission (First half): Start No.=Z0, Number of words=Z1

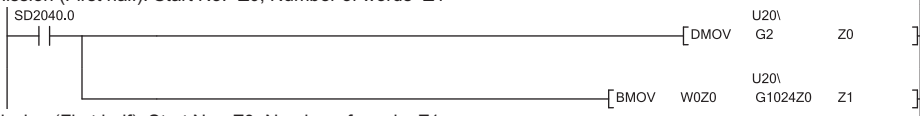

Transfer W of the host station to the local module. (First half)

B transmission (First half): Start No.=Z0, Number of words=Z1

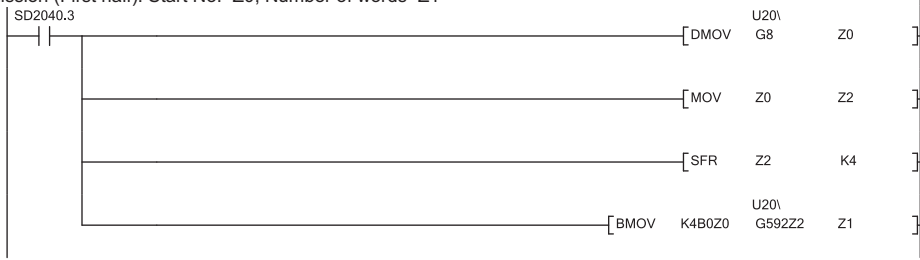

Divide the buffer memory address by 16 (bits).

Transfer B of the host station to the local module. (First half)

W device reception 1 (First half): Start No.=Z0, Number of words=Z1

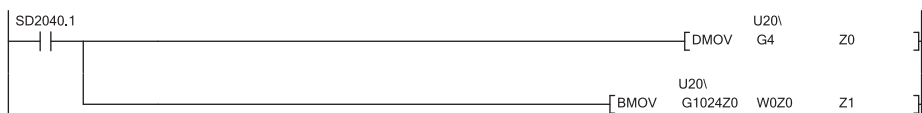

] Obtain W of the other stations from the local module. (First half)

W device reception 2 (First half): Start No.=Z0, Number of words=Z1

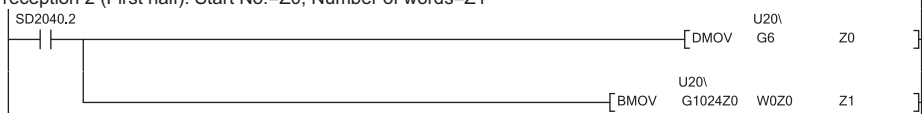

] Obtain W of the other stations from the local module. (First half)

B device reception 1 (First half): Start No.=Z0, Number of words=Z1

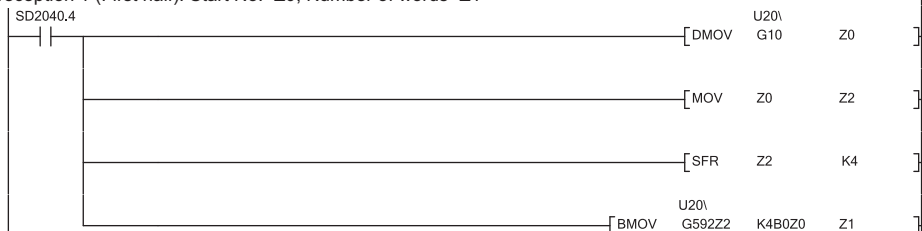

] Divide the buffer memory address by 16 (bits).

] Obtain B of the other stations from the local module. (First half)

B device reception 2 (First half): Start No.=Z0, Number of words=Z1

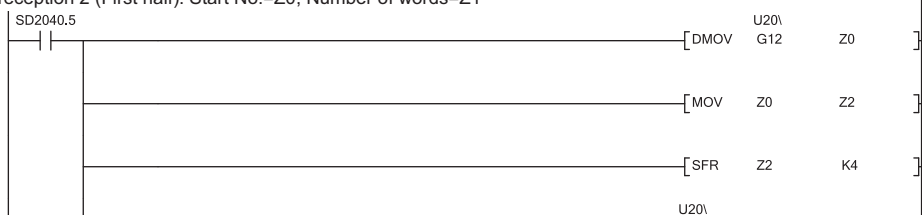

] Divide the buffer memory address by 16 (bits).

] Obtain B of the other stations from the local module. (First half)

Transfer the special relay for link (from M9240) to SM1240.  
Transfer the special register for link (from D9243) to SD1243.

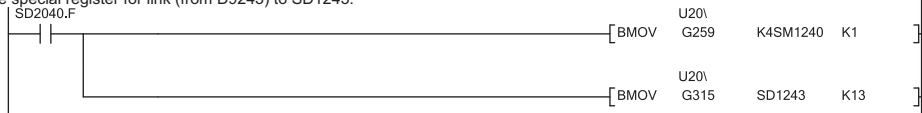

Refresh completion

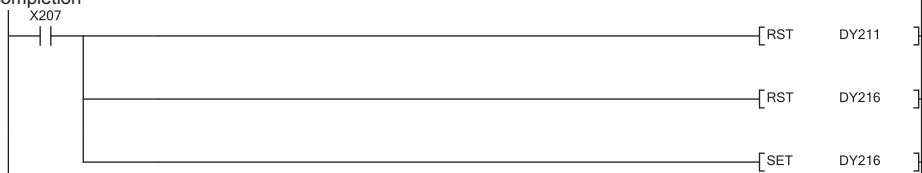

] Obtain data of the special relay (for link).

] Obtain data of the special register (for link).

] Turn OFF the refresh in execution.

Restore the relevant device data.



**2) Condition 2 (Only for the MELSECNET II mode three-tier system)**

- Number of mounted local station data link modules: 1
- Module mounting address: X/Y200 to 21F slot
- Network type: MELSECNET II mode
- Send range for each station setting: Both first half and latter half set
- Master station for the second tier B/W receive program: None (except the local station for the second tier)
- Program for receiving LRDP instruction: Exists
- Program for receiving LWDP instruction: Exists
- X/Y link: Exists
- Refresh device (bit): B00 to FFF
- Refresh device (word): W00 to FFF

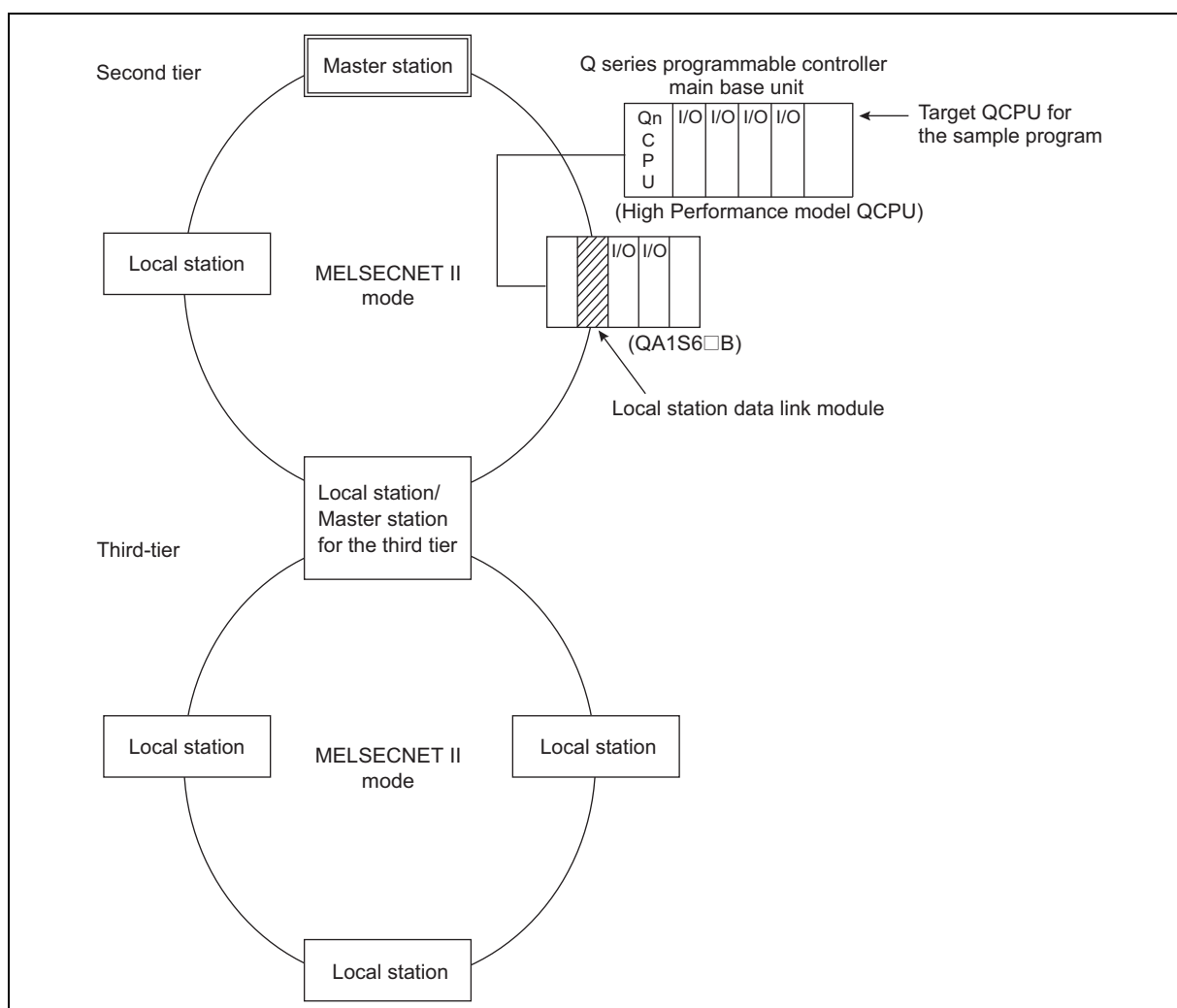

- Setting examples of the A/QnA-Q conversion support tool (Condition setting)

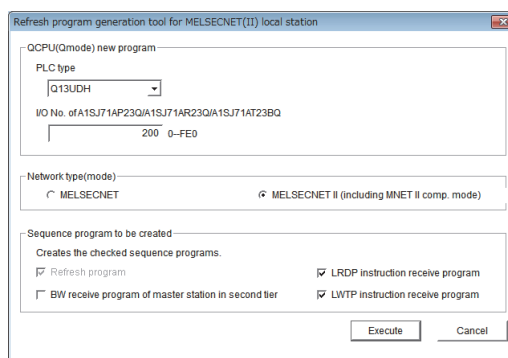

(Refresh device setting)

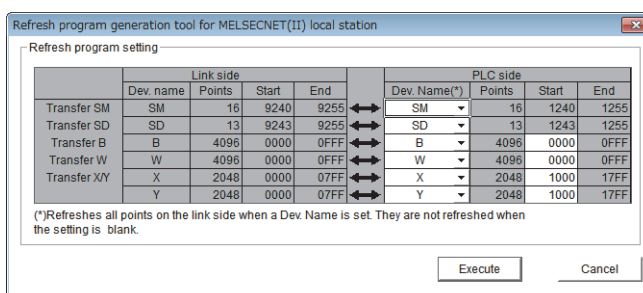

Save the relevant device data in the save area.

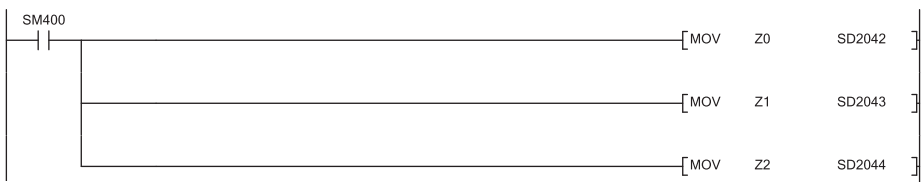

When powered ON, Initialize B/W devices.

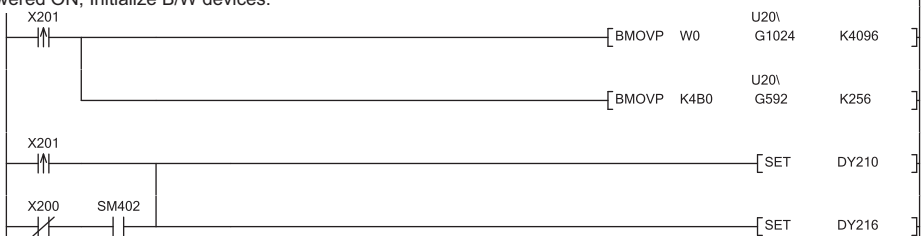

In refresh ready status, start refresh.

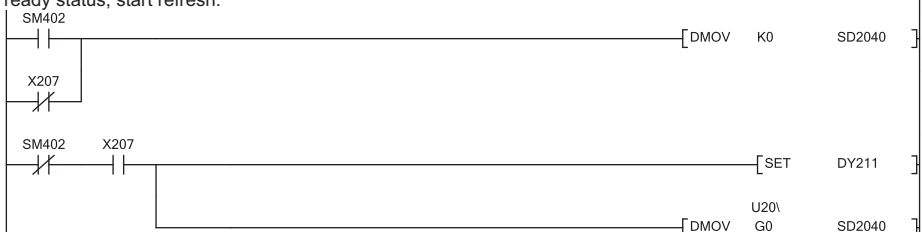

W transmission (First half): Start No.=Z0, Number of words=Z1

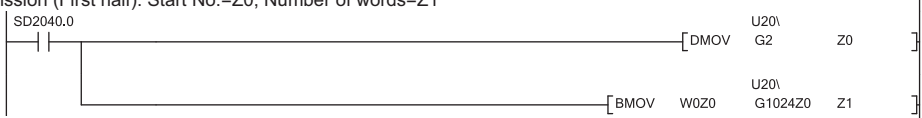

W transmission (Latter half): Start No.=Z0, Number of words=Z1

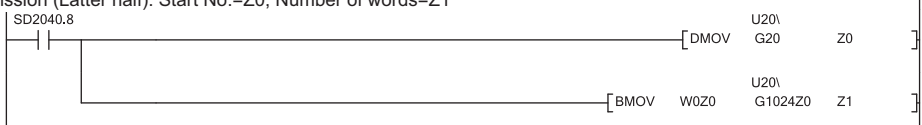



Y device transmission: Start No.=Z0, Number of words=Z1



] Divide the buffer memory address by 16 (bits).  
 ] Transfer Y of the host station to the local module.

B transmission (First half): Start No.=Z0, Number of words=Z1

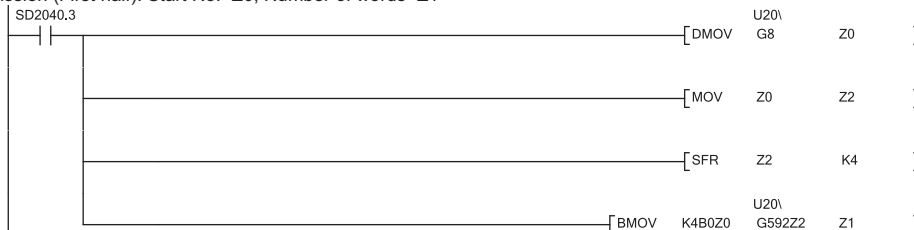

] Divide the buffer memory address by 16 (bits).  
 ] Transfer B of the host station to the local module. (First half)

B transmission (Latter half): Start No.=Z0, Number of words=Z1

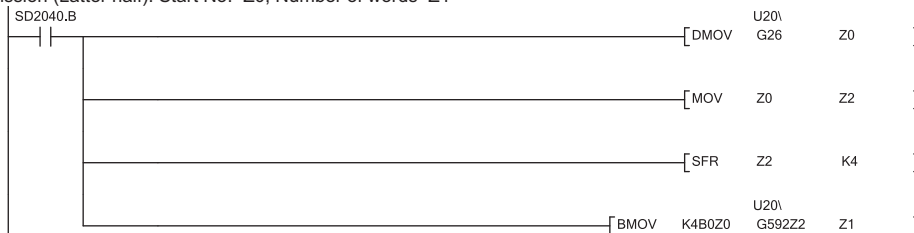

] Divide the buffer memory address by 16 (bits).  
 ] Transfer B of the host station to the local module. (Latter half)

W device reception 1 (First half): Start No.=Z0, Number of words=Z1

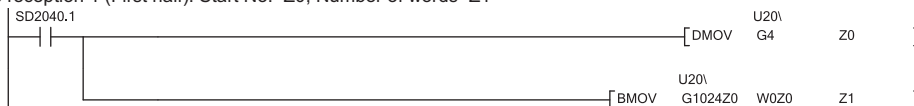

] Obtain W of the other stations from the local module. (First half)

W device reception 2 (First half): Start No.=Z0, Number of words=Z1

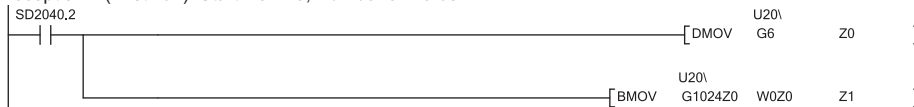

] Obtain W of the other stations from the local module. (First half)

W device reception 1 (Latter half): Start No.=Z0, Number of words=Z1

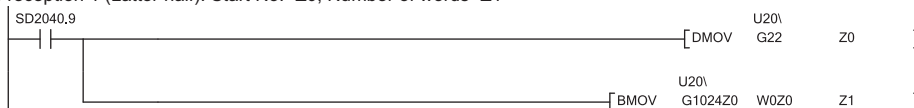

] Obtain W of the other stations from the local module. (Latter half)

W device reception 2 (Latter half): Start No.=Z0, Number of words=Z1

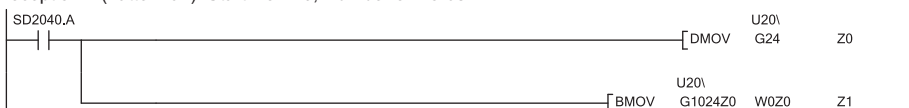

Obtain W of the other stations from the local module. (Latter half)

X device reception: Start No.=Z0, Number of words=Z1

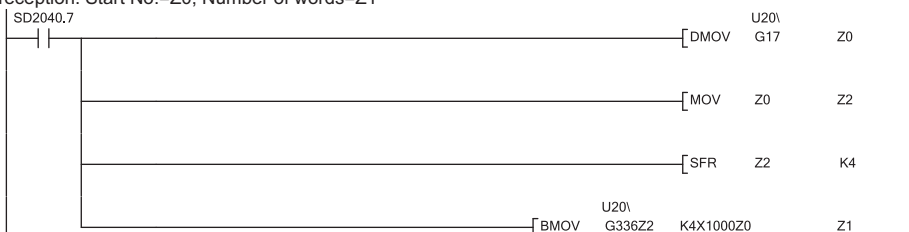

Divide the buffer memory address by 16 (bits).

Obtain X of the host station from the local module.

B device reception 1 (First half): Start No.=Z0, Number of words=Z1

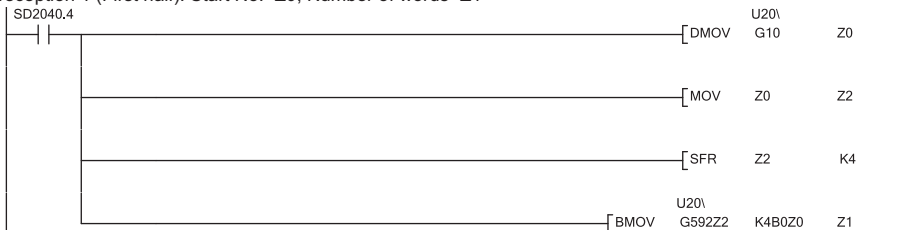

Divide the buffer memory address by 16 (bits).

Obtain B of the other stations from the local module. (First half)

B device reception 2 (First half): Start No.=Z0, Number of words=Z1

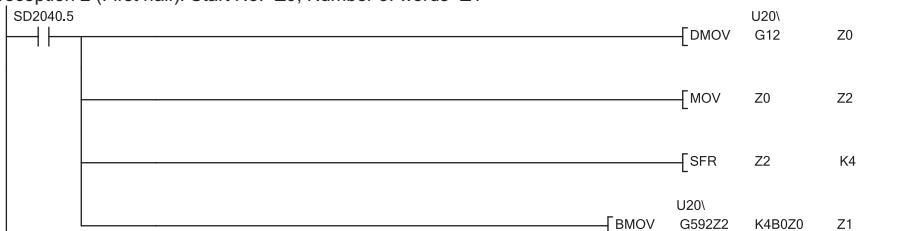

Divide the buffer memory address by 16 (bits).

Obtain B of the other stations from the local module. (First half)

B device reception 1 (Latter half): Start No.=Z0, Number of words=Z1

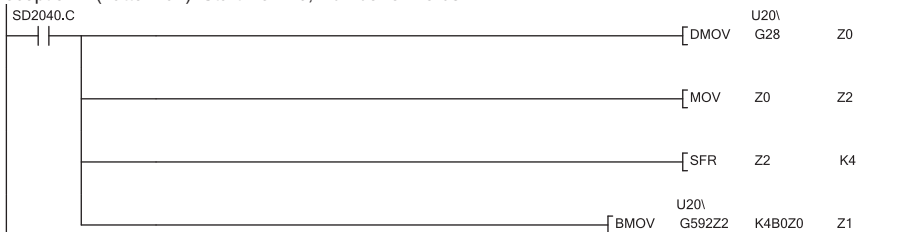

Divide the buffer memory address by 16 (bits).

Obtain B of the other stations from the local module. (Latter half)

B device reception 2 (Latter half): Start No.=Z0, Number of words=Z1

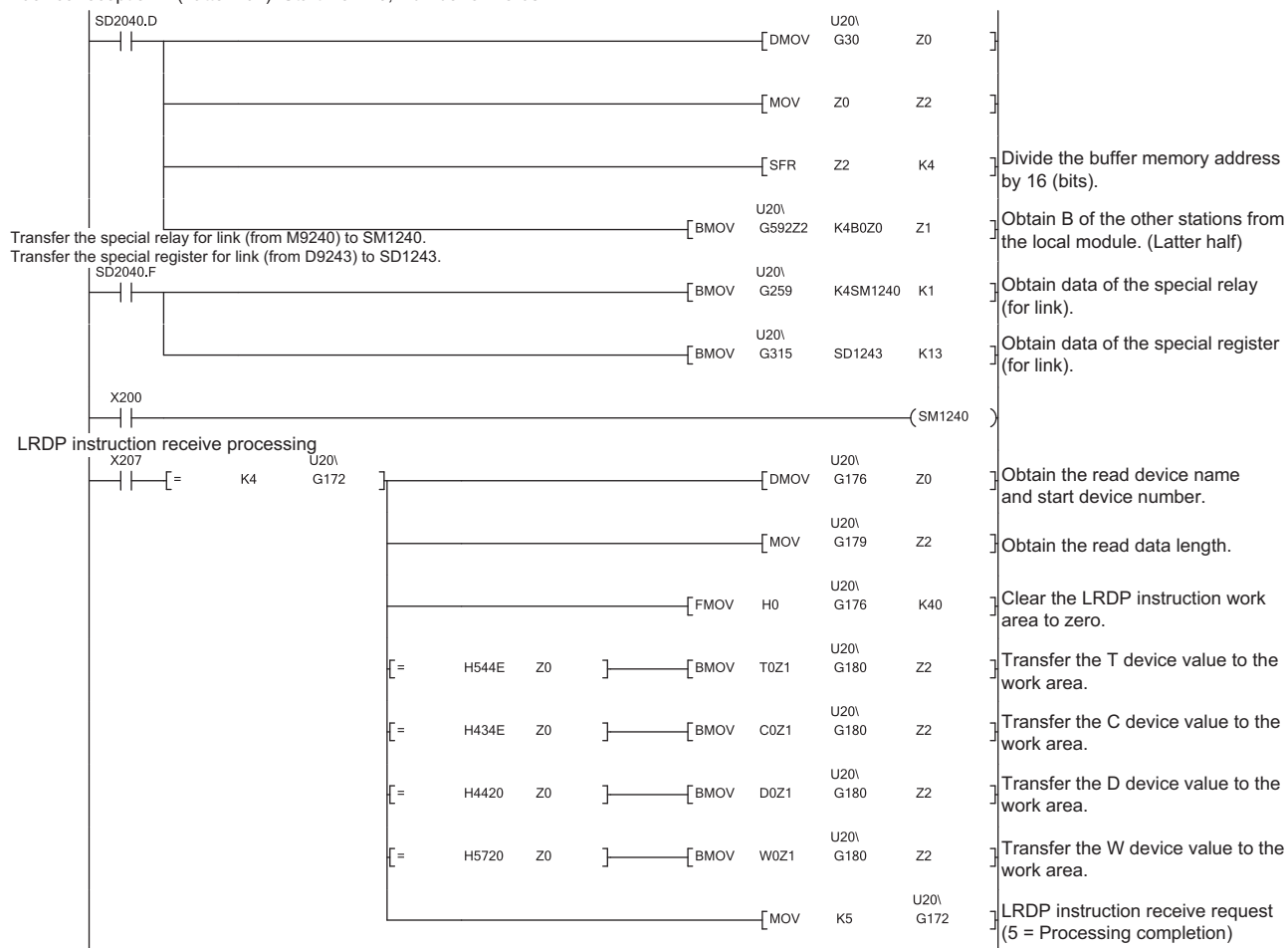

LWTP instruction receive processing

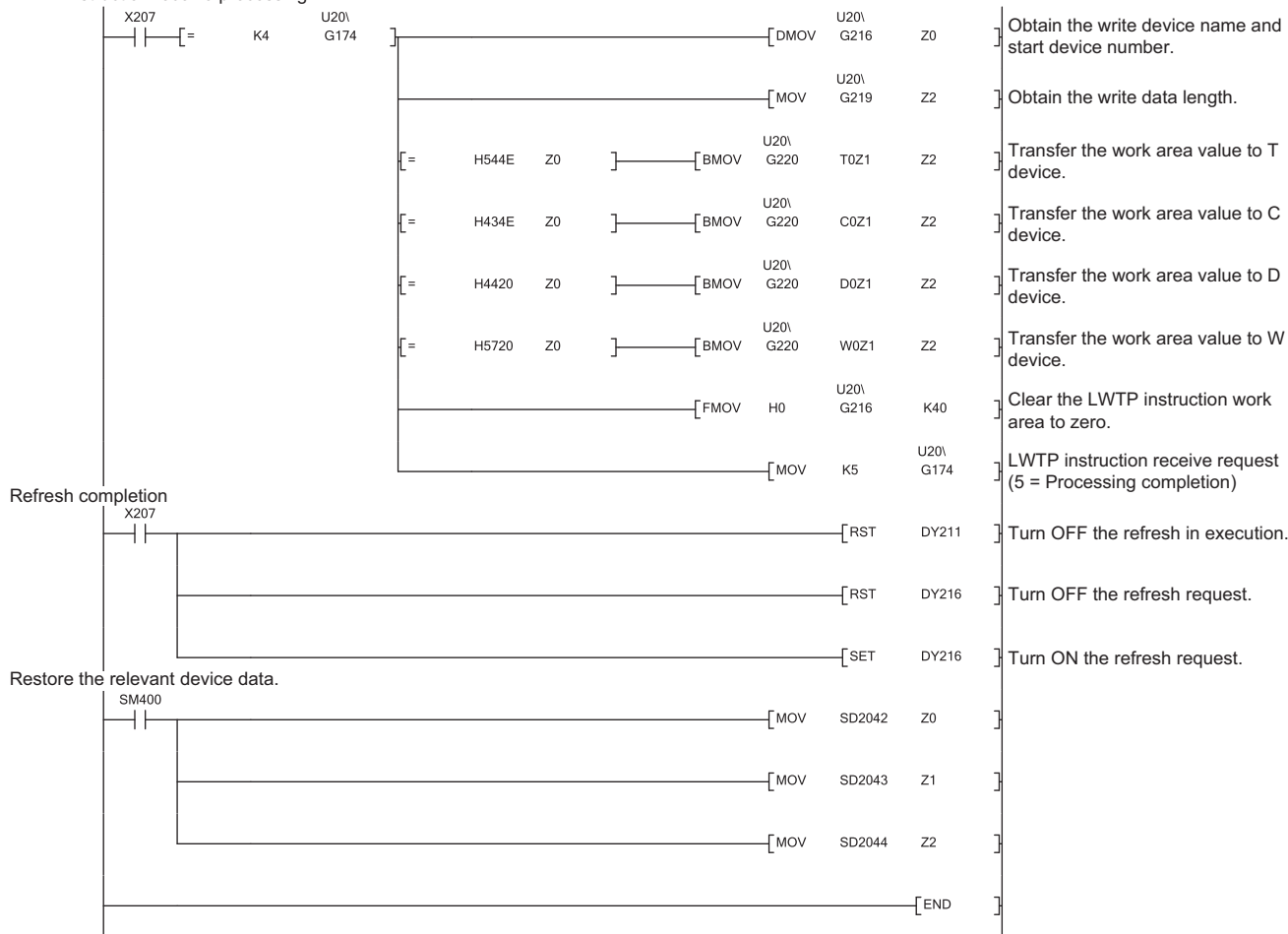

## Appendix 4 Related Manuals

### Appendix 4.1 Replacement handbooks

#### (1) Transition guide

No.	Manual name	Manual number	Model code
1	MELSEC-A/QnA Series Transition Guide	L08077E	-
2	MELSEC-AnS/QnAS Series Transition Guide	L08236E	-

#### (2) Transition from MELSEC-A/QnA (large type) to Q series handbook

No.	Manual name	Manual number	Model code
1	Transition from MELSEC-A/QnA (Large Type) Series to Q Series Handbook (Fundamentals)	L08043ENG	-
	Transition from MELSEC-AnS/QnAS (Small Type) Series to Q Series Handbook (Fundamentals)	L08219ENG	-
2	Transition from MELSEC-A/QnA (Large Type) Series to Q Series Handbook (Intelligent Function Modules)	L08046ENG	-
	Transition from MELSEC-AnS/QnAS (Small Type) Series to Q Series Handbook (Intelligent Function Modules)	L08220ENG	-
3	Transition from MELSEC-A/QnA (Large Type), AnS/QnAS (Small Type) Series to Q Series Handbook (Network Modules)	L08048ENG	-
4	Transition from MELSEC-A/QnA (Large Type), AnS/QnAS (Small Type) Series to Q Series Handbook (Communications)	L08050ENG	-
5	Transition from MELSEC-A0J2H Series to Q Series Handbook	L08060ENG	-
6	Transition from MELSECNET/MINI-S3, A2C (I/O) to CC-Link Handbook	L08061ENG	-
7	Transition from MELSEC-I/OLINK to CC-Link/LT Handbook	L08062ENG	-
8	Transition from MELSEC-I/OLINK to AnyWire DB A20 Handbook	L08263ENG	-
9	Transition of CPUs in MELSEC Redundant System Handbook (Transition from Q4ARCPU to QnPRHCPU)	L08117ENG	-

#### (3) Transition Examples

No.	Manual name	Manual number	Model code
1	MELSEC-A/QnA (Large), AnS/QnAS (Small) Transition Examples	L08121E	-

#### (4) Others

No.	Manual name	Manual number	Model code
1	Precautions for replacing A/QnA (large type) series CPU with Universal model QCPU	FA-A-0068	-

## Appendix 4.2 A/AnS series

No.	Manual name	Manual number	Model code
1	Type MELSECNET, MELSECNET/B Data Link System Reference Manual	IB-66350	13JF70
2	Type MELSECNET/10 Network System Reference Manual (PLC to PLC network)	IB-66440	1JE33
3	Type MELSECNET/10 Network System (Remote I/O network) Reference Manual	SH-3509	13JE72
4	CC-Link System Master/Local Module Type AJ61BT11/A1SJ61BT11 User's Manual	IB-66721	13J872

## Appendix 4.3 QnA/QnAS series

No.	Manual name	Manual number	Model code
1	For QnA/Q4AR MELSECNET/10 Network System Reference Manual	IB-66690	13JF78
2	CC-Link System Master/Local Module Type AJ61QBT11/A1SJ61QBT11 User's Manual	IB-66722	13J873

## Appendix 4.4 Q series

No.	Manual name	Manual number	Model code
1	Q Corresponding MELSECNET/H Network System Reference Manual(PLC to PLC network)	SH-080049	13JF92
2	Q Corresponding MELSECNET/H Network System Reference Manual(Remote I/O network)	SH-080124	13JF96
3	Q Corresponding MELSECNET/H Remote I/O Module Reference Manual (MELSECNET/10 Mode)	SH-081164ENG	13JV30
4	CC-Link System Master/Local Module User's Manual QJ61BT11N	SH-080394E	13JR64
5	MELSEC-Q/L Programming Manual (Common Instruction)	SH-080809ENG	13JW10

# **WARRANTY**

Please confirm the following product warranty details before using this product.

## **1. Gratis Warranty Term and Gratis Warranty Range**

If any faults or defects (hereinafter "Failure") found to be the responsibility of Mitsubishi occurs during use of the product within the gratis warranty term, the product shall be repaired at no cost via the sales representative or Mitsubishi Service Company.

However, if repairs are required onsite at domestic or overseas location, expenses to send an engineer will be solely at the customer's discretion. Mitsubishi shall not be held responsible for any re-commissioning, maintenance, or testing on-site that involves replacement of the failed module.

[Gratis Warranty Term]

The gratis warranty term of the product shall be for one year after the date of purchase or delivery to a designated place. Note that after manufacture and shipment from Mitsubishi, the maximum distribution period shall be six (6) months, and the longest gratis warranty term after manufacturing shall be eighteen (18) months. The gratis warranty term of repair parts shall not exceed the gratis warranty term before repairs.

[Gratis Warranty Range]

- (1) The range shall be limited to normal use within the usage state, usage methods and usage environment, etc., which follow the conditions and precautions, etc., given in the instruction manual, user's manual and caution labels on the product.
- (2) Even within the gratis warranty term, repairs shall be charged for in the following cases.
  1. Failure occurring from inappropriate storage or handling, carelessness or negligence by the user. Failure caused by the user's hardware or software design.
  2. Failure caused by unapproved modifications, etc., to the product by the user.
  3. When the Mitsubishi product is assembled into a user's device, Failure that could have been avoided if functions or structures, judged as necessary in the legal safety measures the user's device is subject to or as necessary by industry standards, had been provided.
  4. Failure that could have been avoided if consumable parts (battery, backlight, fuse, etc.) designated in the instruction manual had been correctly serviced or replaced.
  5. Failure caused by external irresistible forces such as fires or abnormal voltages, and Failure caused by force majeure such as earthquakes, lightning, wind and water damage.
  6. Failure caused by reasons unpredictable by scientific technology standards at time of shipment from Mitsubishi.
  7. Any other failure found not to be the responsibility of Mitsubishi or that admitted not to be so by the user.

## **2. Onerous repair term after discontinuation of production**

- (1) Mitsubishi shall accept onerous product repairs for seven (7) years after production of the product is discontinued. Discontinuation of production shall be notified with Mitsubishi Technical Bulletins, etc.
- (2) Product supply (including repair parts) is not available after production is discontinued.

## **3. Overseas service**

Overseas, repairs shall be accepted by Mitsubishi's local overseas FA Center. Note that the repair conditions at each FA Center may differ.

## **4. Exclusion of loss in opportunity and secondary loss from warranty liability**

Regardless of the gratis warranty term, Mitsubishi shall not be liable for compensation to:

- (1) Damages caused by any cause found not to be the responsibility of Mitsubishi.
- (2) Loss in opportunity, lost profits incurred to the user by Failures of Mitsubishi products.
- (3) Special damages and secondary damages whether foreseeable or not, compensation for accidents, and compensation for damages to products other than Mitsubishi products.
- (4) Replacement by the user, maintenance of on-site equipment, start-up test run and other tasks.

## **5. Changes in product specifications**

The specifications given in the catalogs, manuals or technical documents are subject to change without prior notice.

Microsoft and Windows are either registered trademarks or trademarks of Microsoft Corporation in the United States and/or other countries.

Unicode is either a registered trademark or a trademark of Unicode, Inc. in the United States and other countries.

The company names, system names and product names mentioned in this manual are either registered trademarks or trademarks of their respective companies.

In some cases, trademark symbols such as '™' or '®' are not specified in this manual.





# Programmable Controller

Country/Region	Sales office	Tel/Fax
USA	MITSUBISHI ELECTRIC AUTOMATION, INC. 500 Corporate Woods Parkway, Vernon Hills, IL 60061, U.S.A.	Tel : +1-847-478-2100 Fax : +1-847-478-2253
Mexico	MITSUBISHI ELECTRIC AUTOMATION, INC. Mexico Branch Mariano Escobedo #69, Col. Zona Industrial, Tlalnepantla Edo. Mexico, C.P.54030	Tel : +52-55-3067-7500
Brazil	MITSUBISHI ELECTRIC DO BRASIL COMÉRCIO E SERVIÇOS LTDA. Avenida Adelino Cardana, 293, 21 andar, Bethaville, Barueri SP, Brazil	Tel : +55-11-4689-3000 Fax : +55-11-4689-3016
Germany	MITSUBISHI ELECTRIC EUROPE B.V. German Branch Mitsubishi-Electric-Platz 1, 40882 Ratingen, Germany	Tel : +49-2102-486-0 Fax : +49-2102-486-1120
UK	MITSUBISHI ELECTRIC EUROPE B.V. UK Branch Travellers Lane, Hatfield, Hertfordshire, AL10 8XB, U.K.	Tel : +44-1707-28-8780 Fax : +44-1707-27-8695
Ireland	MITSUBISHI ELECTRIC EUROPE B.V. Irish Branch Westgate Business Park, Ballymount, Dublin 24, Ireland	Tel : +353-1-4198800 Fax : +353-1-4198890
Italy	MITSUBISHI ELECTRIC EUROPE B.V. Italian Branch Centro Direzionale Colleoni-Palazzo Sirio Viale Colleoni 7, 20864 Agrate Brianza(Milano) Italy	Tel : +39-039-60531 Fax : +39-039-6053-312
Spain	MITSUBISHI ELECTRIC EUROPE, B.V. Spanish Branch Carretera de Rubí, 76-80-Apdo. 420, 08190 Sant Cugat del Vallés (Barcelona), Spain	Tel : +34-935-65-3131 Fax : +34-935-89-1579
France	MITSUBISHI ELECTRIC EUROPE B.V. French Branch 25, Boulevard des Bouvets, 92741 Nanterre Cedex, France	Tel : +33-1-55-68-55-68 Fax : +33-1-55-68-57-57
Czech Republic	MITSUBISHI ELECTRIC EUROPE B.V. Czech Branch Avenir Business Park, Radlicka 751/113e, 158 00 Praha5, Czech Republic	Tel : +420-251-551-470 Fax : +420-251-551-471
Poland	MITSUBISHI ELECTRIC EUROPE B.V. Polish Branch ul. Krakowska 50, 32-083 Balice, Poland	Tel : +48-12-347-65-00 Fax : +48-12-630-47-01
Sweden	MITSUBISHI ELECTRIC EUROPE B.V. (Scandinavia) Fjellievägen 8, SE-22736 Lund, Sweden	Tel : +46-8-625-10-00 Fax : +46-46-39-70-18
Russia	MITSUBISHI ELECTRIC (RUSSIA) LLC St. Petersburg Branch Piskarevsky pr. 2, bld 2, lit "Sch", BC "Benuea", office 720; 195027 St. Petersburg, Russia	Tel : +7-812-633-3497 Fax : +7-812-633-3499
Turkey	MITSUBISHI ELECTRIC TURKEY A.Ş Ümraniye Branch Serifali Mah. Kale Sok. No:41 34775 Umraniye - Istanbul, Turkey	Tel : +90-216-969-2500 Fax : +90-216-526-3995
UAE	MITSUBISHI ELECTRIC EUROPE B.V. Dubai Branch Dubai Silicon Oasis, P.O.BOX 341241, Dubai, U.A.E.	Tel : +971-4-3724716 Fax : +971-4-3724721
South Africa	ADROIT TECHNOLOGIES 20 Waterford Office Park, 189 Witkoppen Road, Fourways, South Africa	Tel : +27-11-658-8100 Fax : +27-11-658-8101
China	MITSUBISHI ELECTRIC AUTOMATION (CHINA) LTD. No.1386 Hongqiao Road, Mitsubishi Electric Automation Center, Shanghai, China	Tel : +86-21-2322-3030 Fax : +86-21-2322-3000
Korea	MITSUBISHI ELECTRIC AUTOMATION KOREA CO., LTD. 7F-9F, Gangseo Hangang Xi-tower A, 401, Yangcheon-ro, Gangseo-Gu, Seoul 07528, Korea	Tel : +82-2-3660-9530 Fax : +82-2-3664-8372
Singapore	MITSUBISHI ELECTRIC ASIA PTE. LTD. 307, Alexandra Road, Mitsubishi Electric Building, Singapore 159943	Tel : +65-6473-2308 Fax : +65-6476-7439
Thailand	MITSUBISHI ELECTRIC FACTORY AUTOMATION (THAILAND) CO., LTD. 12th Floor, SV.City Building, Office Tower 1, No. 896/19 and 20 Rama 3 Road, Kwaeng Bangpongpan, Khet Yannawa, Bangkok 10120, Thailand	Tel : +66-2682-6522 Fax : +66-2682-6020
Vietnam	MITSUBISHI ELECTRIC VIETNAM COMPANY LIMITED Hanoi Branch 6th Floor, Detech Tower, 8 Ton That Thuyet Street, My Dinh 2 Ward, Nam Tu Liem District, Hanoi, Vietnam	Tel : +84-4-3937-8075 Fax : +84-4-3937-8076
Malaysia	MITSUBISHI ELECTRIC SALES MALAYSIA SDN. BHD. Lot 11, Jalan 219, 46100 Petaling Jaya, Selangor Darul Ehsan, Malaysia	Tel : +60-3-7626-5000 Fax : +60-3-7658-3544
Indonesia	PT. MITSUBISHI ELECTRIC INDONESIA Gedung Jaya 11th Floor, JL. MH. Thamrin No.12, Jakarta Pusat 10340, Indonesia	Tel : +62-21-3192-6461 Fax : +62-21-3192-3942
India	MITSUBISHI ELECTRIC INDIA PVT. LTD. Pune Branch Emerald House, EL-3, J Block, M.I.D.C., Bhosari, Pune-411026, Maharashtra, India	Tel : +91-20-2710-2000 Fax : +91-20-2710-2100
Australia	MITSUBISHI ELECTRIC AUSTRALIA PTY. LTD. 348 Victoria Road, P.O. Box 11, Rydalmere, N.S.W 2116, Australia	Tel : +61-2-9684-7777 Fax : +61-2-9684-7245

## MITSUBISHI ELECTRIC CORPORATION

HEAD OFFICE: TOKYO BLDG., 2-7-3, MARUNOUCHI, CHIYODA-KU, TOKYO 100-8310, JAPAN  
NAGOYA WORKS: 1-14, YADA-MINAMI 5-CHOME, HIGASHI-KU, NAGOYA 461-8670, JAPAN