

CC-Link IE TSN

e-Factory

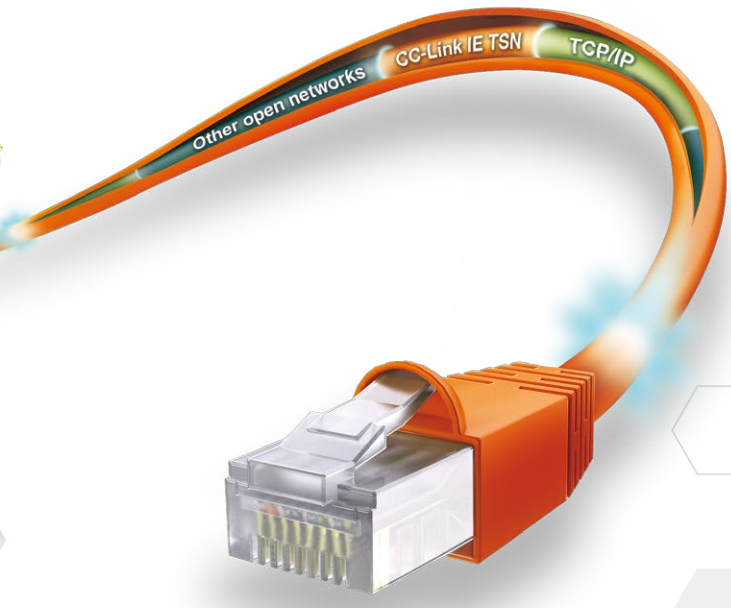

CC-Link **IE** TSN



e-F@ctory

Maximize productivity and reduce costs with an intelligent smart factory solution

Intelligent smart factories utilize high-speed networks with large data bandwidths to meet current manufacturing needs. The combination of CC-Link IE TSN and Mitsubishi Electric's e-F@ctory solution ensures robust integration between IT and factory automation systems, providing an intelligent smart factory solution that reduces total cost while improving operations, production yield, and efficient management of the supply chain. e-F@ctory is the Mitsubishi Electric solution for adding value across the manufacturing enterprise by enhancing productivity, thereby simultaneously reducing maintenance and operating costs, and enabling the seamless flow of information throughout the plant. e-F@ctory uses a combination of factory automation and IT technologies in combination with various best-in-class partner products through its alliance program.

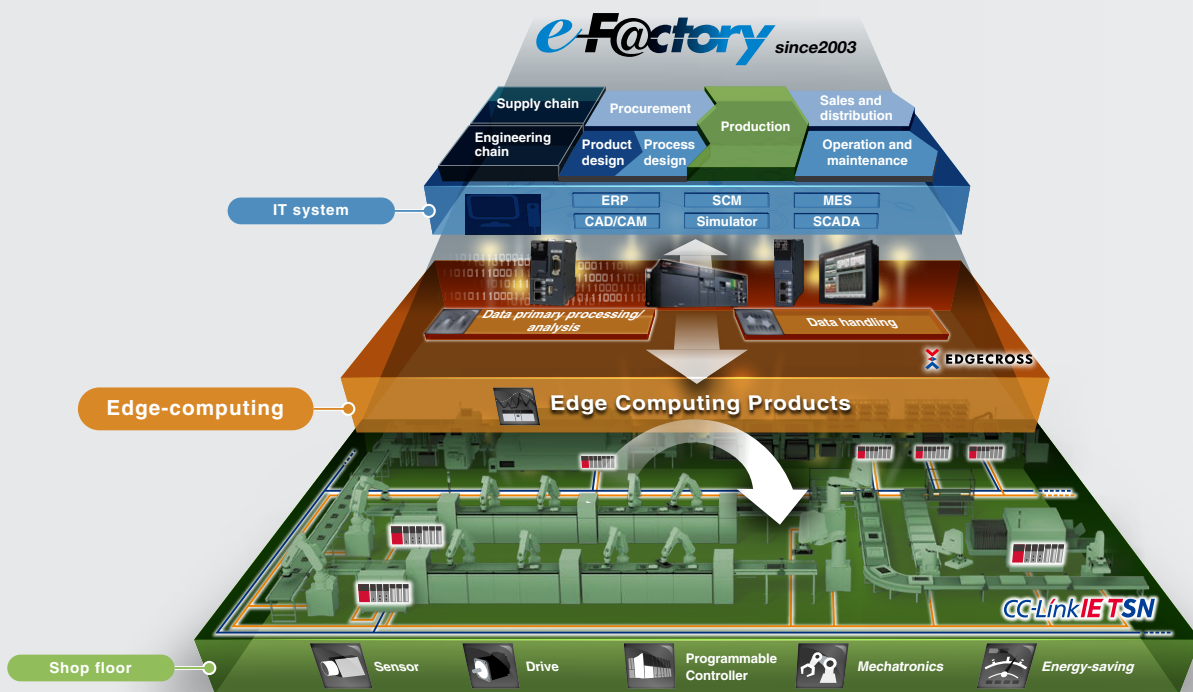

e-F@ctory

CC-Link IE TSN

- IT integration
- Open technology

- High speed, Time synchronization
- Network integration

MELSEC iQ-R

GOT2000

MELSEC iQ-F

MELFA FR

MELSERVO-J5

FREQROL-A800/E800

MITSUBISHIELECTRIC
CNC C80

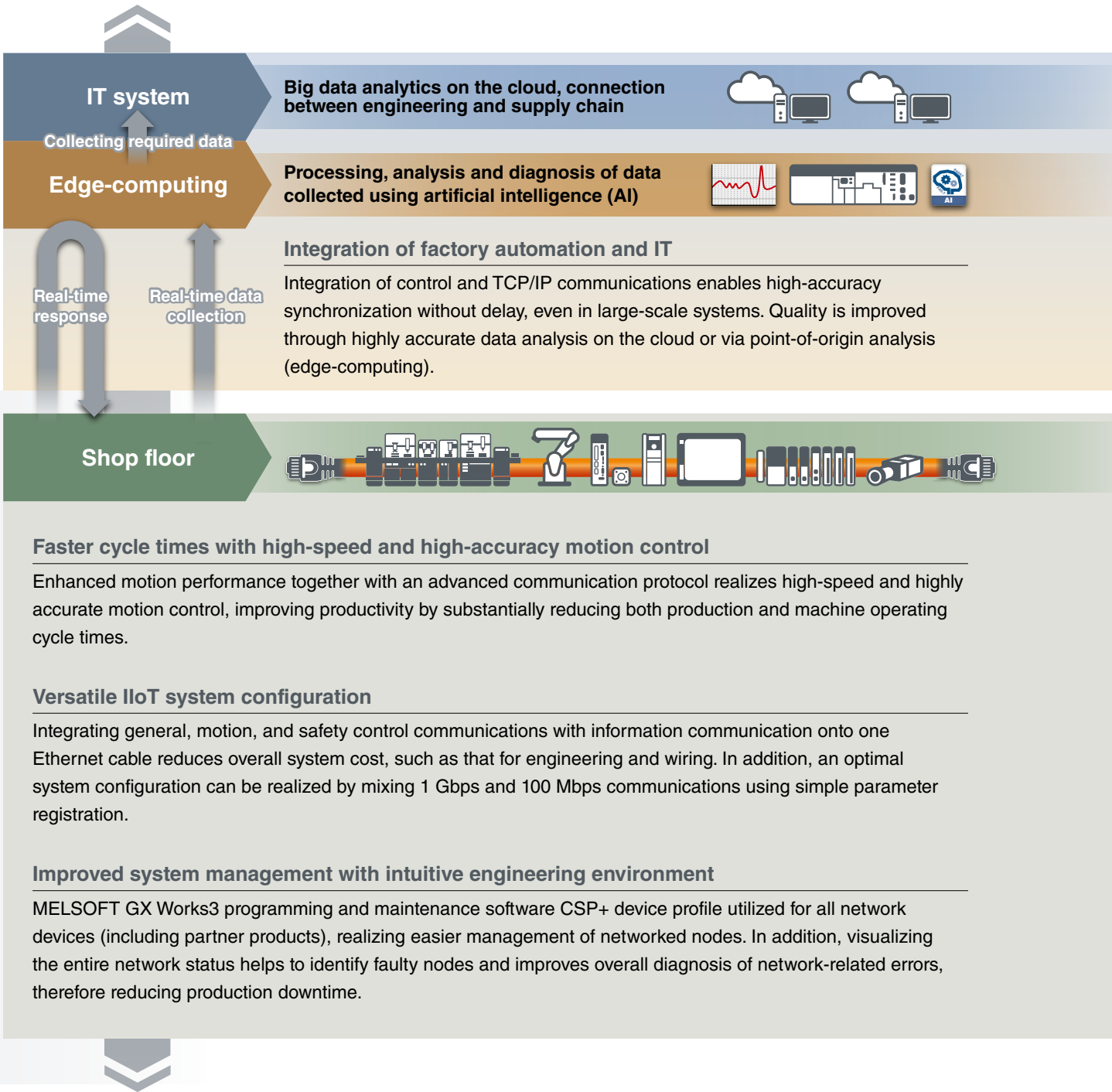

Open integrated networking across the manufacturing enterprise

Leveraging an integrated and open network utilizing TSN technology realizes real-time data collection from the shop floor to IT systems

CC-Link IE TSN supports TCP/IP communications and applies it to industrial architectures through its support of TSN enabling real-time communications. With its flexible system architecture and extensive setup and troubleshooting features make CC-Link IE TSN ideal for building an IIoT infrastructure across the entire manufacturing enterprise.

* TSN: Time Sensitive Networking
* IIoT: Industrial Internet of Things

CC-Link IE TSN

Realize a smart factory integrating factory automation products and IT



Performance

Current manufacturing trends are utilizing AI and predictive maintenance to ensure high productivity and quality are achieved simultaneously. This requires high-speed communication and deterministic control of large volumes of data to IT systems. The innovative communication technology of CC-Link IE TSN increases communication performance, enables highly accurate motion control and high-speed I/O control without adversely affecting operating performance.

Intelligence

Intelligent networks that support industrial communications to realize easy device setup and preventive maintenance are essential for efficient operations. CC-Link IE TSN supports third-party diagnostic software, enabling troubleshooting of network devices (including standard Ethernet). Network event errors are time-stamped, enabling the actual cause of error to be easily evaluated. In addition, automatic generation of network system architectures and parameters simplifies commissioning.

Connectivity

CC-Link IE TSN is the key to realizing real-time communication in manufacturing systems utilizing TCP/IP-compatible Ethernet-based networks. It also enables third-party networks and standard Ethernet devices such as vision sensors and wireless routers to be integrated, and has multiple topology possibilities in support of highly scalable and flexible system architectures.

The contents described in this catalog include features that will be supported in the future. Contents may change without prior notice.



CC-Link IE TSN
"IIoT system" movie



CC-Link IE TSN
"Integrated motion" movie

What is Time-Sensitive Networking (TSN)?

TSN is the IEEE-defined standard technology that enables deterministic messaging on standard Ethernet. The technology ensures deterministic communications by utilizing the time synchronization method (IEEE 802.1AS) and time-sharing method (IEEE 802.1Qbv). With the addition of these standards to Ethernet technology, real-time control communication and non-real time information communication can be mixed, which is not possible with conventional Ethernet communications.

TSN Technology : Features utilizing TSN technology

Seamless communication between various factory automation products and IT systems, realizing an IIoT-enabled network

Open integrated network realizing high-speed cyclic and information communications on the same network

Real-time and synchronized communications enabling high-accuracy motion control and event processing

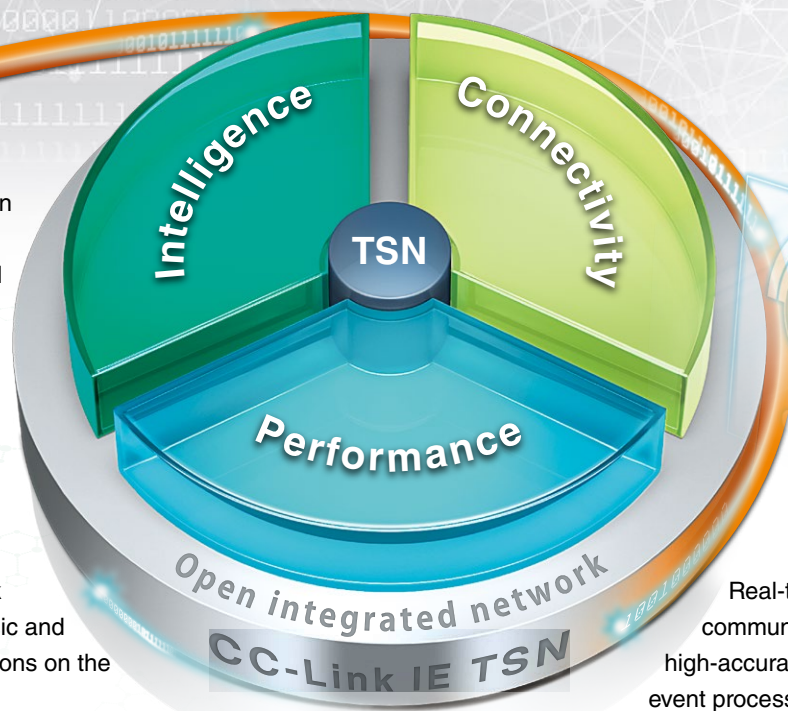

Productivity

- High-speed and large data capacity
- High-accuracy motion control
- High performance even with various cyclic speeds



Diagnostics

- System-wide synchronization responding to errors
- Easier troubleshooting supporting third-party diagnostic tools



Open Technology

- Flexible system structure utilizing standard Ethernet technology
- Realize IIoT through seamless data across multiple layers



Integration

- Both control and information communications on the same line



Commissioning

- Reduce engineering cost with easy system changes



Flexibility

- Multiple topologies supported, realizing easy configuration
- Easier integration supporting multiple protocols on one network
- Highly scalable system utilizing best-in-class devices



Safety

- Integration of safety and general control into one network



Security

- Multi-level security protecting plant data



Performance

High-speed and large bandwidth ideal for systems requiring deterministic control



Productivity

High-speed and large data capacity

CC-Link IE TSN is a versatile network that supports gigabit Ethernet and large data capacity enabling large volumes of data, such as that for production, quality and control, to be managed between different production processes. It also supports 100 Mbps communication for devices with slower response speeds and fewer points.

High-speed processing 16x ^{*1}	Link points 2x ^{*2}
---	--

High-accuracy motion control

Advanced synchronization and high-speed communication reduce overall operating cycle time and maintain cycle times even when servo control axes are increased. This is ideal for machines that require multiple servo axes.

Min. communication cycle 31.25 ^{*3} μ s	Synchronization accuracy ± 1 μ s	Max. number of synchronized axes 256
--	--	--

High performance even with various cyclic speeds

Various devices having different response times can be intermixed on the same control cycle without having a detrimental effect on the overall operating cycle time. This is useful when high-speed communication devices ideal for motion control and slower speed communication devices ideal for monitoring are to be combined.

Communication cycle 3 set points
--



Integration

Supports control and information communications on the same line TSN Technology

Highly scalable integrated networks that simultaneously support information and control data communications on the same line are realized without slowing down the control communication cycle.

^{*1}. Comparison with CC-Link IE Field Network Motion
^{*2}. Comparison with CC-Link IE Field Network
^{*3}. This value is achieved when fast operation mode of the motion module (RD78GH) is used.
 For details, please refer to the MELSEC iQ-R Motion Module User's Manual (Application) (IB-0300411ENG).

Real-time network performance even when integrated with IT

TSN technology enables the transfer of deterministic communication even when delivering the information communication data of IT systems on the same network. By increasing network bandwidth and giving priority to CC-Link IE TSN communications and TCP/IP communications, devices that use general Ethernet communications can be connected to the same network without affecting real-time control communication performance.

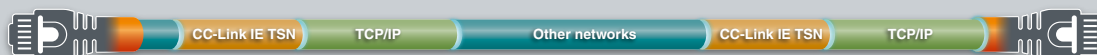

Gigabit Ethernet meets TSN technology

CC-Link IE TSN combines protocols to high-speed cyclic communication and TSN technology. Current manufacturing trends require high-speed communication, deterministic cycle times and the management of large amounts of data. TSN technology allows TCP/IP communication to be added to the network without compromising the control communication necessary for device operation. The protocol also realizes the high-speed transfer of large-capacity data, thereby shortening cycle times and improving productivity.

- Real-time deterministic control using standard Ethernet
- Allocation of control communication bandwidth over IT
- Supports multiple protocols on same network line
- Fast cycle time using time-sharing method and bidirectional communications



Optimum cycle time when mixing devices with different communication cycles

High-speed communication devices ideal for high-speed/high accuracy control and slower response devices ideal for monitoring can be combined by separating the communication cycle according to its speed. This can maximize productivity realizing optimum communication cycles according to the device performance.

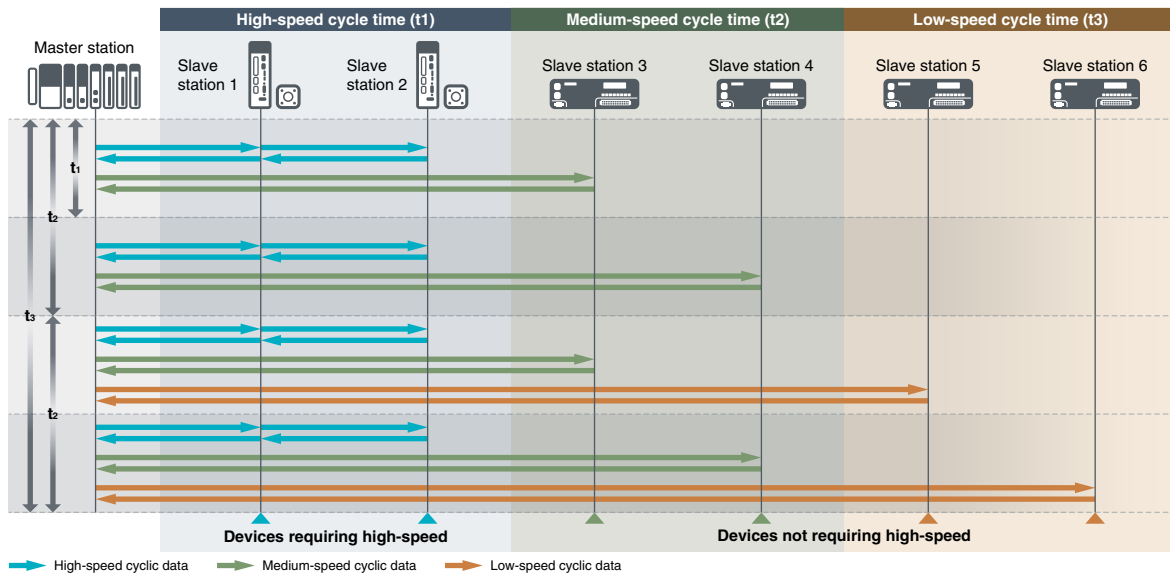

Intelligence

Extensive network technology supporting reduced downtime and easier system implementation



Diagnostics

System-wide synchronization responding to errors TSN Technology

System diagnostics and troubleshooting are improved by supporting sequence of events (SoE) features of each node. Highly accurate synchronization enables the registration of error and event data based on the same clock, reducing downtime and maintenance cost.

Sequence of events

Third-party diagnostic tools support simplifies troubleshooting

By supporting SNMP*1, system-wide monitoring of CC-Link IE TSN and Ethernet devices is possible using general Ethernet diagnostics software, thereby simplifying the troubleshooting of basic network-related errors.

*1. SNMP: Simple network management protocol

Easy diagnostics



Safety

Safety and general control in one network

Safety communication compliant with IEC 61784-3 can be combined with general control communication without requiring separate networks. Both safety and general control programs can be managed together using the same engineering software.



Commissioning

Reduce engineering cost with easy system changes

The network configuration can be automatically updated as device parameters are reflected when a device is added to or replaced in the system, thereby reducing engineering cost. Since system parameters are saved in the master module, there is no need to re-register slave parameters when replacing a slave device.

Easy setup



Security

Multi-level security protecting plant data

Production and control data can be protected from external unauthorized access by utilizing security features supported in CC-Link IE TSN devices. Functions such as user authentication can be implemented, preventing unauthorized access from multiple personnel using the same computer.



Future-proof

Ensure latest functional version with firmware update

Using the CC-Link IE TSN Firmware Update Tool ensures that current modules can be updated utilizing newer features.

Multiple features enabling a robust and easy-to-use communications network

CC-Link IE TSN can utilize extensive troubleshooting tools through its support of GX Works3 and third-party monitoring and diagnostic software based on the SNMP protocol. In addition, parameters are distributed automatically, making it easy to setup slave devices and simplifying the commissioning process.

- Extensive maintenance and easy setup of network devices
- Supports third-party monitoring tools based on SNMP
- Automatic registration of slave device parameters
- Event history based on time stamp simplifies diagnostics and troubleshooting



TSN technology and protocol layers

High performance and functionality are realized owing to the use of the time-sharing method and TSN time-division protocol. Time division optimizes the communication frame and enables the mixing of standard Ethernet communications. Standard Ethernet protocol is also incorporated, enabling Ethernet devices and diagnostic tools to be utilized.

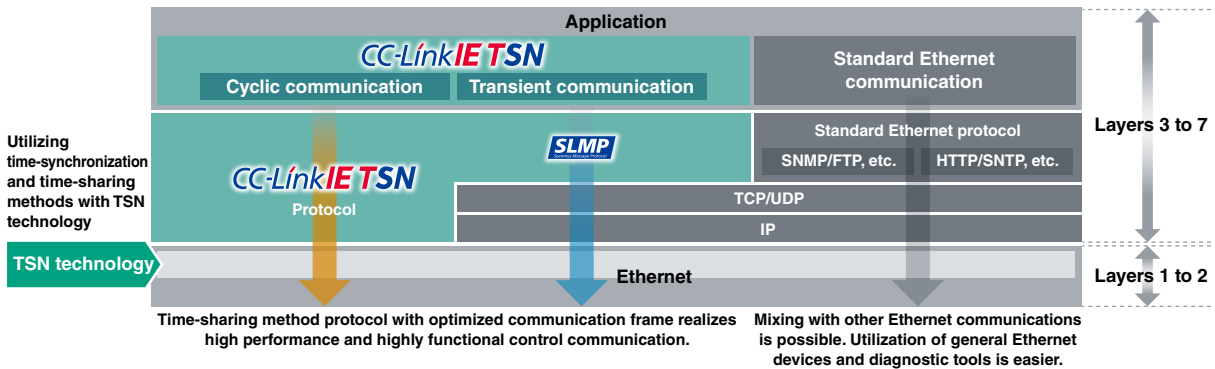

Supports various tools for improving setup and maintenance

CC-Link IE TSN enables setting of network and supported devices, programming, and diagnostics using GX Works3. CC-Link IE TSN communication software realizes easier data collection without the need to change network settings. General-purpose third-party tools supporting SNMP can further enhance the maintenance capabilities of the network.

GX Works3 system setting screen

GX Works3 system monitoring and diagnostics

CC-Link IE TSN communication software for Windows®

SNMP-supported system management software



Connectivity

Optimal system with a highly flexible and integrated (general, motion and safety) network



Standard Ethernet

Flexible system structure utilizing standard Ethernet technology

TSN Technology

Through its support of standard Ethernet, various network-supported devices can be utilized, realizing an integrated network infrastructure. Ethernet devices supporting TCP/IP can be connected easily without requiring dedicated network cables or gateways, reducing hardware cost.

Standard Ethernet

Realize IIoT through seamless data across multiple layers

TSN Technology

Integration of the IT layer through utilization of TSN technology enables seamless communication throughout the network system. Communication of machine-level data across the production floor can be easily integrated with the IT system to realize the use of real-time data for supply and engineering chains, thereby further optimizing production efficiency.

Utilize TSN technology



Wireless

Connecting devices such as wireless routers enables remote access, simplifying maintenance and production monitoring.



Flexibility

Multiple topology support for various configurations

Supporting multiple network topologies on the same network enhances system construction flexibility. Realize optimal systems capable of meeting diversified requirements by integrating various devices without affecting network performance.

Flexible system

Easier integration with various protocols on the same line

TSN Technology

Integrate existing control systems using other open networks with minimal impact on configuration and hardware costs. Communication with enterprise devices using protocols such as OPC UA also supported, enable easier monitoring and control of the entire plant.

Mixed communications

Highly scalable system utilizing best-in-class devices

Supports implementation of high-performance devices realized with a dedicated ASIC/FPGA, and low-cost devices using a software protocol stack on a standard Ethernet chip. Utilizing best-in-class devices that support either 1 Gbps or 100 Mbps communication speeds, optimal systems can be constructed.

Various devices

Seamless communication across entire network

Integrating TCP/IP communication and CC-Link IE TSN for IT data and control data, respectively, realizes seamless communication throughout the entire network. Large amounts of data, such as images from vision sensors communicating via Ethernet, can be processed by other control devices elsewhere in the line without affecting the control data cycle time. Data from various machine processes can also be logged continuously and fed into edge-computing devices, which is essential for predictive maintenance that uses AI algorithms.

- Flexible configurations enable utilization of best-in-class devices
- Multiple topologies supported, line, star and ring
- Supports various TSN-compatible open networks
- Utilizes standard TCP/IP devices



Smart factory integration combining IT systems such as OPC UA with networked devices supporting other communication protocols

Build fully connected factory networks with vertical and horizontal integration across many different layers, automation control zones and network nodes. Realize system optimization on the same network while reducing overall network hardware and software costs.

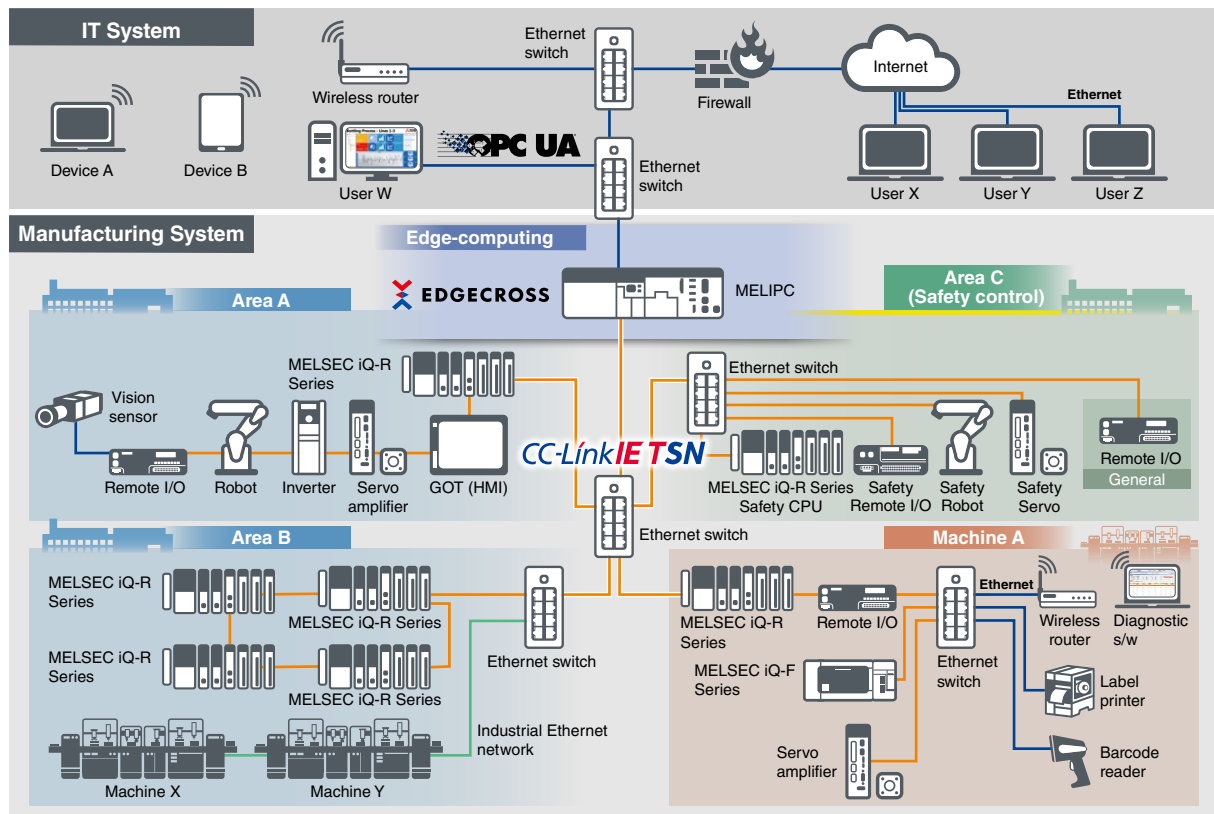

Applications

Lithium-ion battery – Coater –

Users Benefit

- Highly accurate motion control of multiple axes
- Mixing of multiple cyclic communication cycles

Lithium-ion battery production requires a large-scale production line that includes electrode formation, stacking, inspection, packaging, and shipping processes. Utilizing various Mitsubishi Electric factory automation technologies and products, such as tension control, motion control, synchronization control, robots and IT system coordination (e-F@ctory) in each process enables efficient production of high-quality lithium-ion batteries. Incorporating CC-Link IE TSN enables the mixing of high-speed cyclic control and slower response time control, thereby ensuring maximum performance of each device. Large-scale production lines can be configured, contributing to high-speed, highly accurate motion control, enhanced operation management and quality control throughout the entire factory.

■ Highly accurate motion control of multiple axes

- Devices normally connected to SSCNET and CC-Link IE can be integrated into one network
- Highly accurate synchronous control of multiple axes even when mixed with servos and inverters

■ Mixing of multiple cyclic communication cycles

- High-speed cycle time control (such as servos) and slower response time control (such as inverters and temperature control) can be combined
- Ensures maximum device performance and reduces hardware cost by enabling optimal device selection for applications

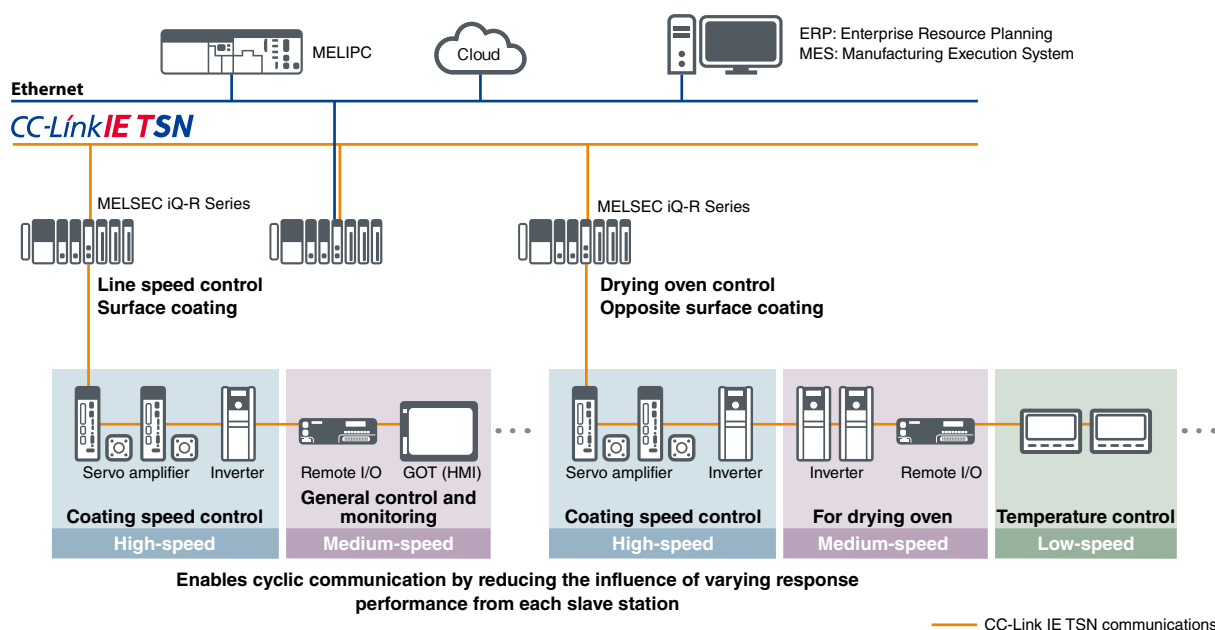

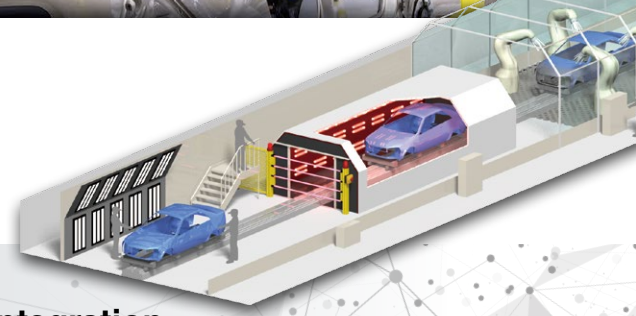

Automotive – Paint Shop –

Users Benefit

- Reduce cost with one network integration
- Simple integration using flexible topologies
- Improve operating cycle time and maintenance with high-speed, large-capacity data communication

Automotive manufacturing was the birth of line assembly where continuously moving production lines are common. With the automated manufacturing boom in the 1970s and introduction of lean manufacturing, the call to reduce inventory and waste and speed up cycle times has dominated the industry. With the onset of digitalization, Industry 4.0, device interconnectivity and large-capacity data, real-time networks that have seamless communication with multiple devices and open networks have become even more essential. With CC-Link IE TSN, the entire supply chain, from IT services and machine/OEM manufacturers to the end user, can utilize its distinct features to realize a smart factory with optimal automotive manufacturing performance.

■ Integrate general, safety, and TCP/IP communications onto one network

- Manage general and safety communications on one network, ensuring control of paint robots and conveyors
- Integrate Ethernet communications on the same network without requiring dedicated couplers

■ Flexible topologies ensure easier system changes and integration into existing lines

- Star, line, and ring topologies are supported, simplifying system layouts and ensuring easier upgrade paths
- Using a TSN-supported switch enables simple integration into existing systems with other networks and factory automation products
- Ring topology ensures data communication integrity when an error occurs using the loop-back function

■ High-speed, large-capacity data communication ensures high-speed processing and easier maintenance

- High-speed processing of paint data utilizing MELSEC IQ-R CPU and fast network performance of CC-Link IE TSN
- Various data from different processes can be transferred to the main controller and IT system utilizing edge devices such as MELIPC

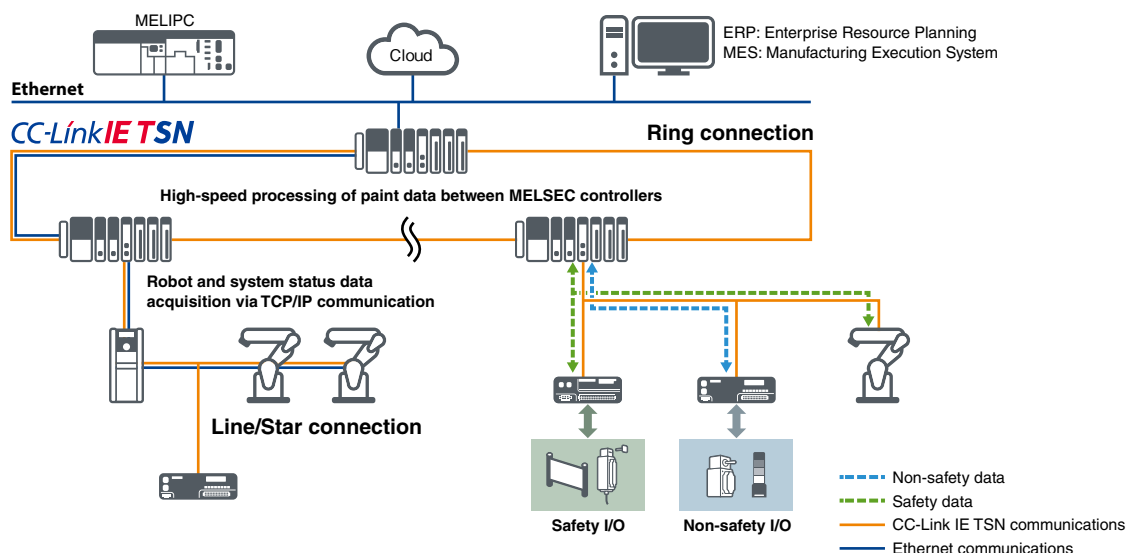



Food & beverage – Filling/CIP –

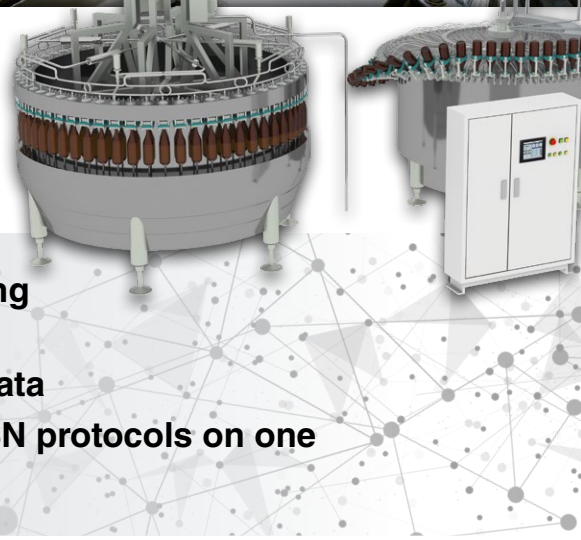

Users Benefit

- **Highly accurate control of packaging process**
- **Efficient collection of traceability data**
- **Supports TCP/IP and CC-Link IE TSN protocols on one network**

Eliminating defects, reducing downtime, and maintaining high productivity are basic requirements within the food and beverage industry; especially where consumers expect high product quality. In the packaging process, ensuring accurate and quick filling/sealing of products are required to avoid unnecessary product wastage and longer manufacturing cycles. In addition, with consumer product quality requirements normally being stringent, a robust, high-speed network that can handle large-capacity data communications is required to collect and process traceability data, which can be used to analyze the root cause of defective products in manufacturing processes.

■ Integrating advanced motion control enables faster machine cycle times and highly accurate processing

- Advanced communication protocol enhances motion performance, realizing high-speed, highly accurate motion control
- Realize synchronous control with direct data communication between servos*1

*1. Future release

■ Real-time collection and analysis of quality data from the shop floor

- Time-stamping traceability information and product filling data enables highly accurate data analysis, improving product quality management

■ Integrate CC-Link IE TSN and Ethernet devices

- Mixing with TCP/IP communication allows utilization of best-in-class Ethernet devices on the same network
- TCP/IP communication is possible without affecting overall machine performance

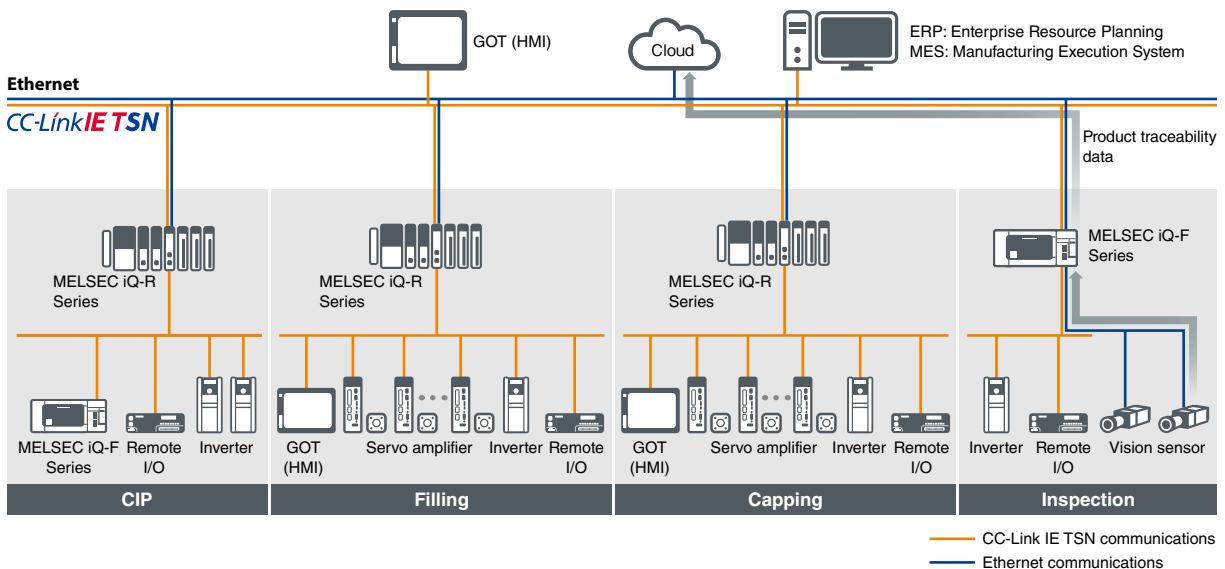

Printing machines



Users Benefit

- High-speed, highly accurate motion control
- Synergy with vision sensors

With the shift to digital media, the printing industry has also experienced a shift from mass continuous printing of small diversified contents for multiple readers to flexible printing where a large variety of contents is printed in small quantity. As the result, printing machines now require multiple functionality that enables efficient production of printed media in various runs, shapes and colors while maintaining high-quality print and productivity. CC-Link IE TSN enables highly accurate synchronization of multiple axes between various printing processes such as converting (paper infeed/outfeed), printing, processing, binding, and sorting. Together with the integration of various sensors and I/Os, highly scalable printing systems can be realized.

■ High-speed, highly accurate motion control system

- Large-scale systems utilizing highly accurate synchronous control of up to 256 axes with a single network master

■ Synergy with vision sensors

- Time synchronization between the servo and vision sensors enables highly accurate positioning by detecting moving workpieces relative to the printing position and compensating any deviation, thereby reducing the overall operating cycle time

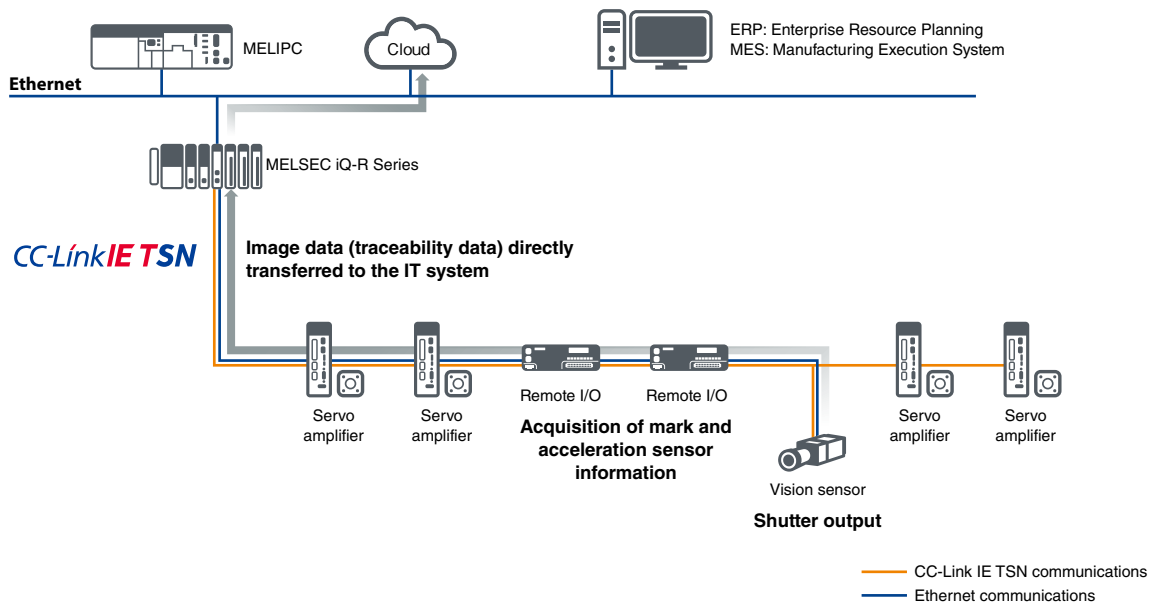

Country/Region	Sales office	Tel/Fax
USA	MITSUBISHI ELECTRIC AUTOMATION, INC. 500 Corporate Woods Parkway, Vernon Hills, IL 60061, U.S.A.	Tel : +1-847-478-2100 Fax : +1-847-478-2253
Mexico	MITSUBISHI ELECTRIC AUTOMATION, INC. Mexico Branch Boulevard Miguel de Cervantes Saavedra 301, Torre Norte Piso 5, Ampliacion Granada, Miguel Hidalgo, Ciudad de Mexico, Mexico, C.P.115200	Tel : +52-55-3067-7512
Brazil	MITSUBISHI ELECTRIC DO BRASIL COMERCIO E SERVICOS LTDA. Avenida Adelino Cardana, 293, 21 andar, Bethaville, Barueri SP, Brasil	Tel : +55-11-4689-3000 Fax : +55-11-4689-3016
Germany	MITSUBISHI ELECTRIC EUROPE B.V. German Branch Mitsubishi-Electric-Platz 1, 40882 Ratingen, Germany	Tel : +49-2102-486-0 Fax : +49-2102-486-7780
UK	MITSUBISHI ELECTRIC EUROPE B.V. UK Branch Travellers Lane, UK-Hatfield, Hertfordshire, AL10 8XB, U.K.	Tel : +44-1707-28-8780 Fax : +44-1707-27-8695
Ireland	MITSUBISHI ELECTRIC EUROPE B.V. Irish Branch Westgate Business Park, Ballymount, Dublin 24, Ireland	Tel : +353-1-4198800 Fax : +353-1-4198890
Italy	MITSUBISHI ELECTRIC EUROPE B.V. Italian Branch Centro Direzionale Colleoni - Palazzo Sirio, Viale Colleoni 7, 20864 Agrate Brianza (MB), Italy	Tel : +39-039-60531 Fax : +39-039-6053-312
Spain	MITSUBISHI ELECTRIC EUROPE, B.V. Spanish Branch Carretera de Rubi, 76-80-Apdo. 420, E-08190 Sant Cugat del Valles (Barcelona), Spain	Tel : +34-935-65-3131 Fax : +34-935-89-1579
France	MITSUBISHI ELECTRIC EUROPE B.V. French Branch 25, Boulevard des Bouvets, 92741 Nanterre Cedex, France	Tel : +33-1-55-68-55-68 Fax : +33-1-55-68-57-57
Czech Republic	MITSUBISHI ELECTRIC EUROPE B.V. Czech Branch, Prague Office Pekarska 621/7, 155 00 Praha 5, Czech Republic	Tel : +420-255-719-200
Poland	MITSUBISHI ELECTRIC EUROPE B.V. Polish Branch ul. Krakowska 48, 32-083 Balice, Poland	Tel : +48-12-347-65-00
Sweden	MITSUBISHI ELECTRIC EUROPE B.V. (Scandinavia) Hedvig Mollersgata 6, 223 55 Lund, Sweden	Tel : +46-8-625-10-00 Fax : +46-46-39-70-18
Russia	MITSUBISHI ELECTRIC (RUSSIA) LLC St. Petersburg Branch Piskarevsky pr. 2, bld 2, lit "Sch", BC "Benua", office 720; 195027 St. Petersburg, Russia	Tel : +7-812-633-3497 Fax : +7-812-633-3499
Turkey	MITSUBISHI ELECTRIC TURKEY A.S. Umraniye Branch Serifali Mah. Kale Sok. No:41 34775 Umraniye - Istanbul, Turkey	Tel : +90-216-969-2500 Fax : +90-216-661-4447
UAE	MITSUBISHI ELECTRIC EUROPE B.V. Dubai Branch Dubai Silicon Oasis, P.O.BOX 341241, Dubai, U.A.E.	Tel : +971-4-3724716 Fax : +971-4-3724721
South Africa	ADROIT TECHNOLOGIES 20 Waterford Office Park, 189 Witkoppen Road, Fourways, South Africa	Tel : +27-11-658-8100 Fax : +27-11-658-8101
China	MITSUBISHI ELECTRIC AUTOMATION (CHINA) LTD. Mitsubishi Electric Automation Center, No.1386 Hongqiao Road, Shanghai, China	Tel : +86-21-2322-3030 Fax : +86-21-2322-3000
Taiwan	SETSUYO ENTERPRISE CO., LTD. 6F, No.105, Wugong 3rd Road, Wugu District, New Taipei City 24889, Taiwan	Tel : +886-2-2299-2499 Fax : +886-2-2299-2509
Korea	MITSUBISHI ELECTRIC AUTOMATION KOREA CO., LTD. 7F to 9F, Gangseo Hangang Xi-tower A, 401, Yangcheon-ro, Gangseo-Gu, Seoul 07528, Korea	Tel : +82-2-3660-9569 Fax : +82-2-3664-8372
Singapore	MITSUBISHI ELECTRIC ASIA PTE. LTD. 307 Alexandra Road, Mitsubishi Electric Building, Singapore 159943	Tel : +65-6473-2308 Fax : +65-6476-7439
Thailand	MITSUBISHI ELECTRIC FACTORY AUTOMATION (THAILAND) CO., LTD. 12th Floor, SV.City Building, Office Tower 1, No. 896/19 and 20 Rama 3 Road, Kwaeng Bangpongpan, Khet Yannawa, Bangkok 10120, Thailand	Tel : +66-2682-6522-31 Fax : +66-2682-6020
Vietnam	MITSUBISHI ELECTRIC VIETNAM COMPANY LIMITED Unit 01-04, 10th Floor, Vincom Center, 72 Le Thanh Ton Street, District 1, Ho Chi Minh City, Vietnam	Tel : +84-28-3910-5945 Fax : +84-28-3910-5947
Indonesia	PT. MITSUBISHI ELECTRIC INDONESIA Gedung Jaya 8th Floor, JL. MH. Thamrin No.12, Jakarta Pusat 10340, Indonesia	Tel : +62-21-31926461 Fax : +62-21-31923942
India	MITSUBISHI ELECTRIC INDIA PVT. LTD. Pune Branch Emerald House, EL-3, J Block, M.I.D.C., Bhosari, Pune-411026, Maharashtra, India	Tel : +91-20-2710-2000 Fax : +91-20-2710-2100
Australia	MITSUBISHI ELECTRIC AUSTRALIA PTY. LTD. 348 Victoria Road, P.O. Box 11, Rydalmere, N.S.W 2116, Australia	Tel : +61-2-9684-7777 Fax : +61-2-9684-7245

Mitsubishi Electric Corporation Nagoya Works is a factory certified for ISO 14001 (standards for environmental management systems) and ISO 9001 (standards for quality assurance management systems).

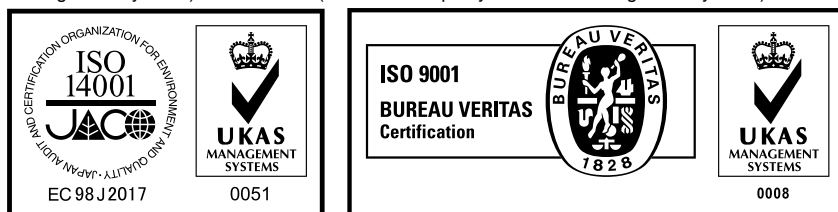

MITSUBISHI ELECTRIC CORPORATION

HEAD OFFICE: TOKYO BLDG., 2-7-3, MARUNOUCHI, CHIYODA-KU, TOKYO 100-8310, JAPAN
www.MitsubishiElectric.com