

Changes for the Better

for a greener tomorrow



FACTORY AUTOMATION

MITSUBISHI INDUSTRIAL ROBOT F Series



MELFA

e-Factory

GLOBAL IMPACT OF MITSUBISHI ELECTRIC



Through Mitsubishi Electric's vision, "Changes for the Better" are possible for a brighter future.

Changes for the Better

We bring together the best minds to create the best technologies. At Mitsubishi Electric, we understand that technology is the driving force of change in our lives. By bringing greater comfort to daily life, maximizing the efficiency of businesses and keeping things running across society, we integrate technology and innovation to bring changes for the better.

Mitsubishi Electric is involved in many areas including the following

Energy and Electric Systems

A wide range of power and electrical products from generators to large-scale displays.

Electronic Devices

A wide portfolio of cutting-edge semiconductor devices for systems and products.

Home Appliance

Dependable consumer products like air conditioners and home entertainment systems.

Information and Communication Systems

Commercial and consumer-centric equipment, products and systems.

Industrial Automation Systems

Maximizing productivity and efficiency with cutting-edge automation technology.

OVERVIEW

Product Lineup	7	1
Robot Specifications	10	2
Controller Specifications	23	3
Functions	26	4
System Configuration	38	6
Configurations Options	39	7
Options	41	

Committed to ever higher customer satisfaction

e-F@ctory

FA integrated solution to reduce the TCO

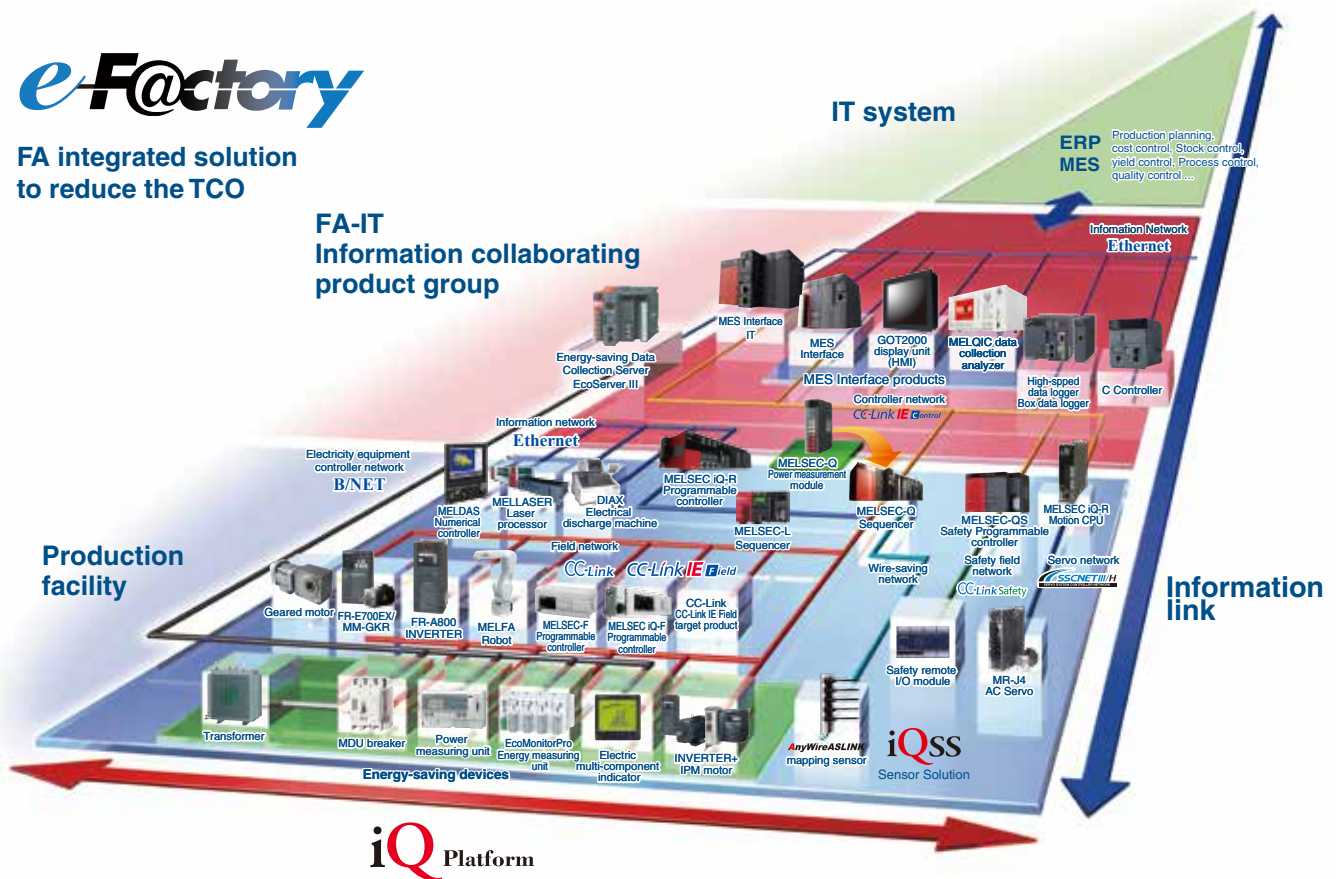

Mitsubishi Electric is a global leader in the research, manufacturing and marketing of electrical and electronic equipment used in areas such as communications, consumer electronics, industrial technology, energy and transportation. Within this, the industrial automation business has grown significantly since the first induction motor was manufactured over 90 years ago and has closely followed the automation industry in Japan, Asia, and

beyond. Mitsubishi Electric industrial automation boasts a wide-range of product areas such as production control, drives, and mechatronics that are used in various industries. In addition, Mitsubishi Electric offers e-F@ctory and iQ Platform, leveraging its total industrial automation solution portfolio. Mitsubishi Electric will keep offering products to customers all over the world as a total supplier of FA.

System example with Mitsubishi FA products

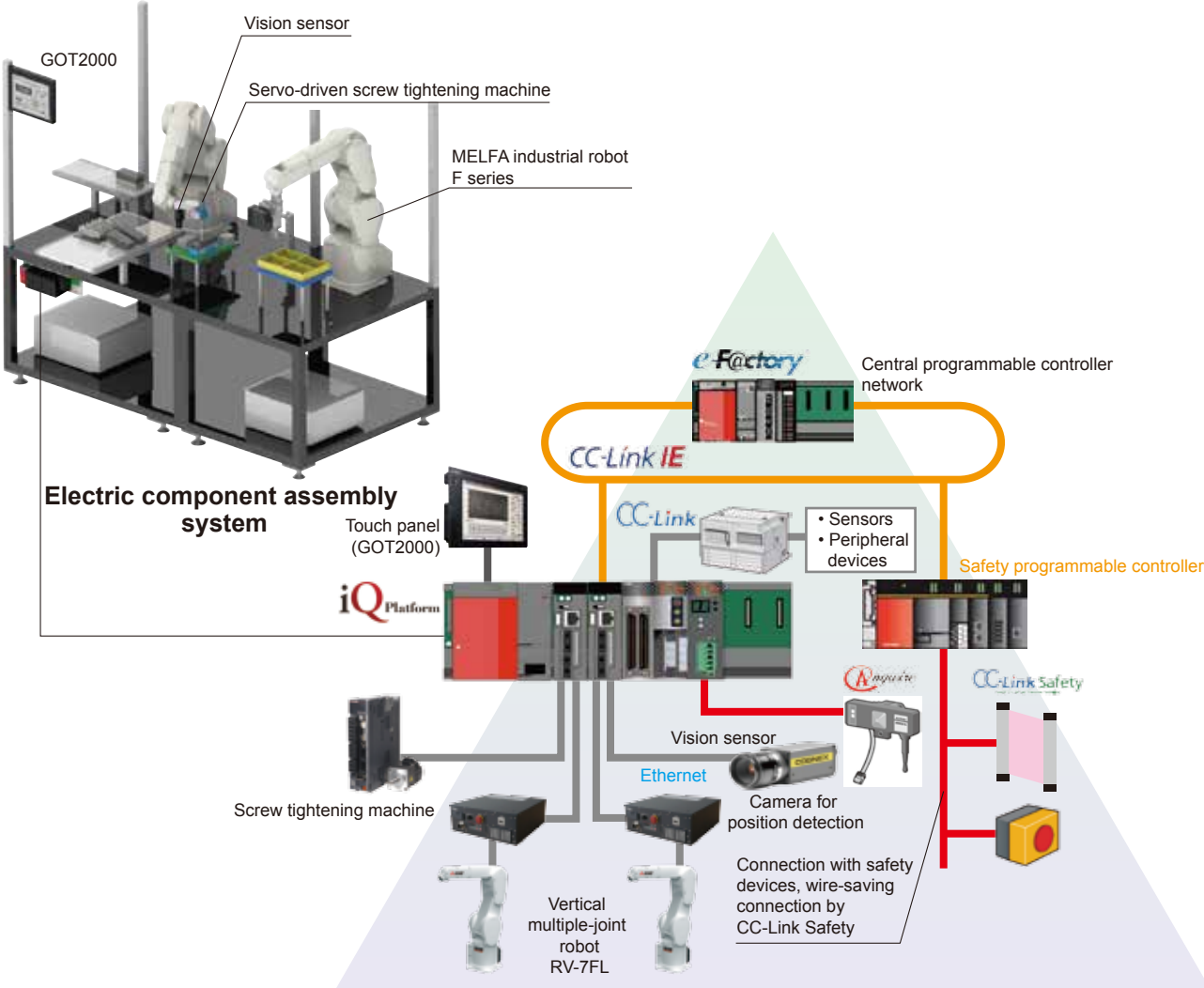

Control device configuration

The manufacturing industry needs to handle changing challenges relating to global competition, employment/procurement, and others. Such challenges can be solved by the "robot-based cell manufacturing", which is suitable for high-mix and various-volume production having no restrictions on places, production volume, and lead time. Mitsubishi Electric has established various test cells for Mitsubishi products to commercialize automated manufacturing facilities using robots and robot-based cell manufacturing. Mitsubishi Electric will find and solve difficulties in systems and each component, and apply the techniques obtained through such processes to robots, functions, and peripheral components to offer solutions meeting market demands.



MELFA F-SERIES

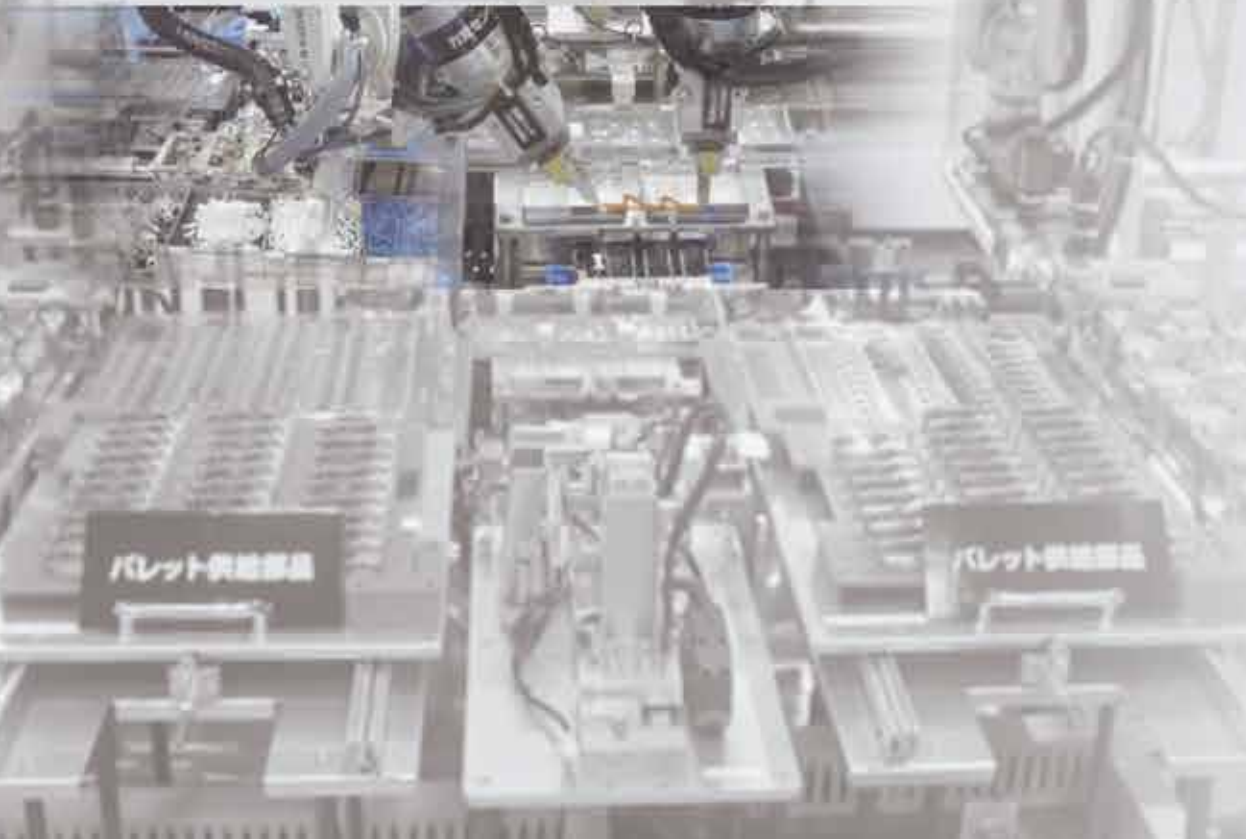

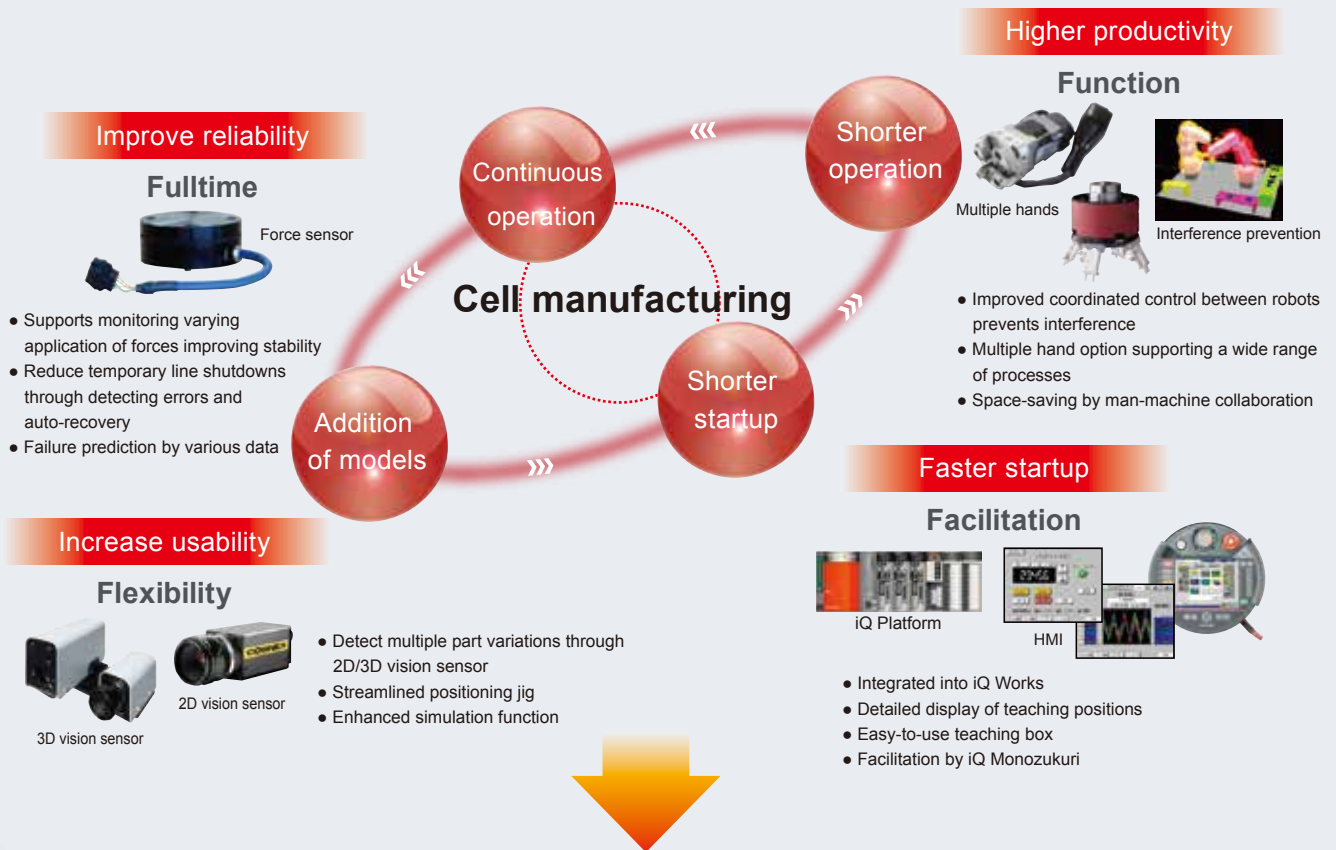

Function development for automation

Intelligence solutions including sensor applications and the integrated controller iQ Platform, iQ Monozukuri containing accumulated know-how as a package, and various engineering software facilitate plan, design operation, and maintenance of robot cells, reducing the total cost of ownership (TCO).

Higher basic performance

Industry-leading performance using advanced servo control techniques and compact arms and multi-function tools suitable for cell production will improve productivity. Cooperative operation with human using the latest safety solution will further improve productivity improvement and contribute to space saving.

Improved reliability

The intelligence solution will allow robots to handle various variations, leading to a stable operation. Further, collected data will be converted into digital data to visualize robot maintenance information, leading to productivity and quality improvement.

MELFA F Series

Mitsubishi Electric's goal is to "reduce TCO" ranging from plan and design to operation and maintenance. Mitsubishi Electric will improve the robot performance and offer the "MELFA F series", which is equipped with "e-F@ctory" and solution techniques developed and tested at its own production plants.

Lineup

With a wide range of variations from Mitsubishi

The Mitsubishi Electric robot product line is equipped with all of the basic performance features desired in a robot, such as being powerful, speedy, and compact.



The variations that Mitsubishi Electric is confident meet the needs of the current era and have pushed Factory Automation forward in a dramatic way.

1

Product Lineup

Vertical, multiple-joint type (RV)



Type		RV-2F	RV-2FL	RV-4F	RV-4FL	RV-7F	RV-7FL
Maximum load capacity (kg)		3		4		7	
Maximum reach radius (mm)		504	649	515	649	713	908
Environmental specifications	Standard	○ (IP30)		○ (IP40)		○ (IP40)	
	Oil mist	—		○ (IP67)		○ (IP67)	
	Clean	—		○ (ISOclass3)		○ (ISOclass3)	
	Medical, food	—		○ (IP65)		○ (IP65)	
Controller		 CR750			 CR751		

Horizontal, multiple-joint type (RH)



Type		RH-3FH35	RH-3FH45	RH-3FH55	RH-6FH35	RH-6FH45	RH-6FH55
Maximum load capacity (kg)		3	3	3	6	6	6
Maximum reach radius (mm)		350	450	550	350	450	550
Environmental specifications	Standard	○ (IP20)			○ (IP20)		
	Oil mist	—			○ (IP65)		
	Clean	○ (ISOclass3)			○ (ISOclass3)		
	Medical, food	—			○ (IP65)		
Controller		 CR750					

7

Electric, committed to ease in selection.



RV-7FLL	RV-13F	RV-13FL	RV-20F	RV-35F	RV-50F	RV-70F
7	13		20	35	50	70
1503	1094	1388	1094	2050		
○ (IP40)	○ (IP40)		○ (IP40)	○ (J1 to J4:IP40, J5 to J6:IP67)		
○ (IP67)	○ (IP67)		○ (IP67)	○ (IP67)		
○ (ISOclass3)	○ (ISOclass3)		○ (ISOclass3)	—		
○ (IP65)	○ (IP65)		○ (IP65)	—		



Controllers with protective specifications
(Equipped with controller protection boxes)



CR760-D/Q



RH-12FH55	RH-12FH70	RH-12FH85	RH-20FH85	RH-20FH100	RH-3FHR
12	12	12	20	20	3
550	700	850	850	1000	350
○ (IP20)			○ (IP20)		○ (IP20)
○ (IP65)			○ (IP65)		Water proof: ○ (IP65)
○ (ISOclass3)			○ (ISOclass3)		○ (ISOclass5)
○ (IP65)			○ (IP65)		—



CR751



Controllers with protective specifications
(Equipped with controller protection boxes)

Models

Vertical, multiple-joint type (RV)

RV - 4 F L C - D 1 - Sxx

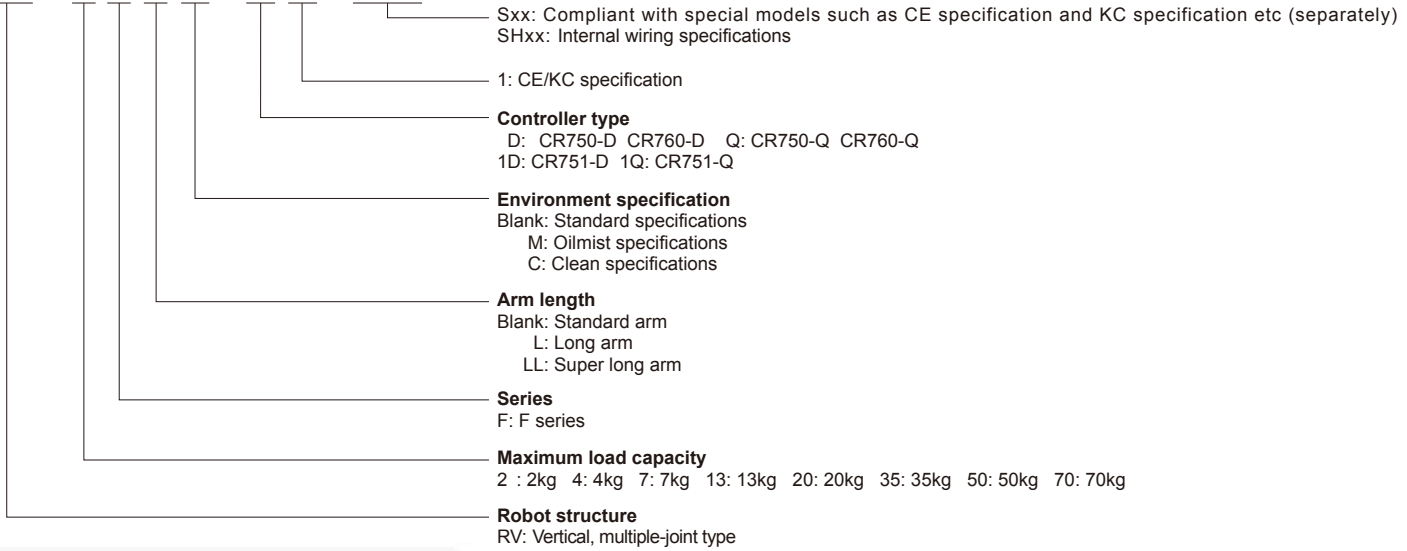

Horizontal, multiple-joint type (RH)

RH - 6 FH 55 20 M - D 1 - Sxx

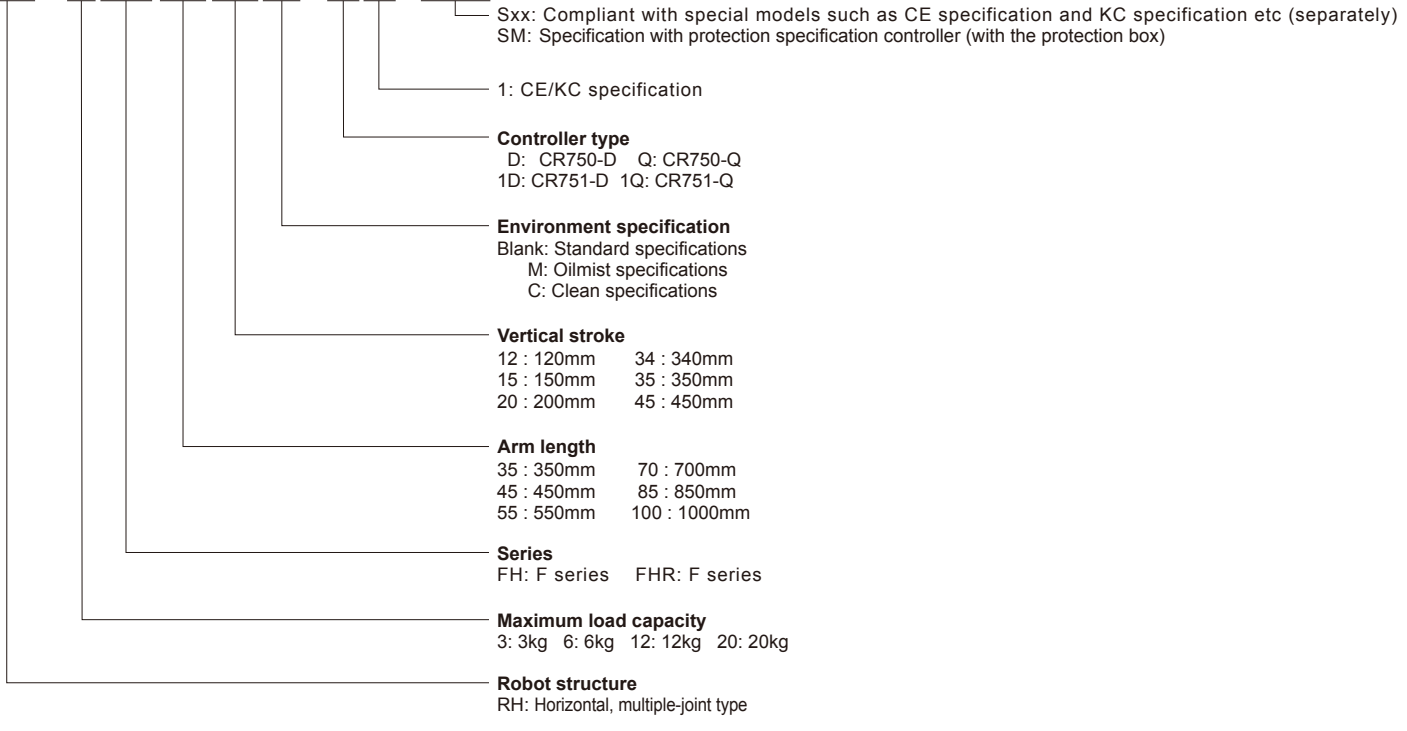



Vertical
2 kg
type

RV-2F RV-2FL

External Dimensions/Operating Range Diagram

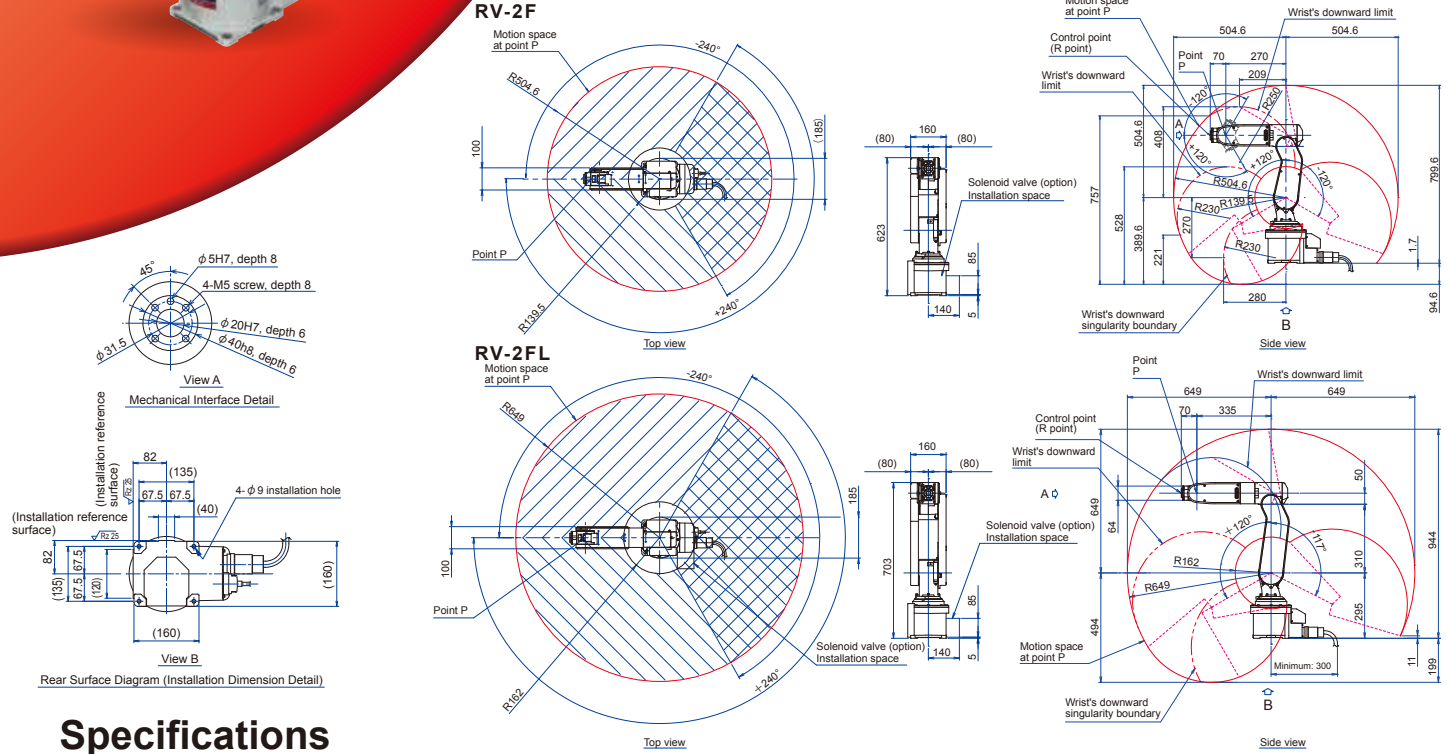

2
Robot Specifications

Specifications

Type	Unit	RV-2F(B)	RV-2FL(B)
Environmental specifications		Standard	
Protection degree		IP30	
Installation		Floor type, ceiling type, (wall-mounted type *2)	
Structure		Vertical, multiple-joint type	
Degrees of freedom		6	
Drive system *1		AC servo motor (J2, J3 and J5: with brake)	
Position detection method		Absolute encoder	
Maximum load capacity		maximum 3 (Rated 2) *5	
Arm length	NO1 arm	mm	230 + 270
Maximum reach radius		mm	504
Operating range	J1	deg	480 (±240)
	J2		240 (-120 to +120)
	J3		160 (-0 to +160)
	J4		400 (±200)
	J5		240 (-120 to +120)
	J6		720 (-360 to +360)
Maximum speed	J1	deg/sec	300
	J2		150
	J3		300
	J4		450
	J5		450
	J6		720
Maximum composite speed *3	mm/sec	4955	4200
Cycle time *4	sec	0.6	0.7
Position repeatability	mm	±0.02	
Ambient temperature	°C	0 to 40	
Mass	kg	19	21
Tolerable moment	J4	Nm	4.17
	J5		4.17
	J6		2.45
Tolerable amount of inertia	J4	kgm ²	0.18
	J5		0.18
	J6		0.04
Tool wiring	Hand: 4 input points/4 output points Signal cable for the multi-function hand		
Tool pneumatic pipes	φ 4 x 4		
Machine cable	5m (connector on both ends)		
Connected controller	CR750, CR751		

*1: The standard model does not have a brake on the J1, J4, or J6 axis. There are models available with brakes included for all axes. (RV-2FB)
 *2: The wall-mounted specification is a custom specification where the operating range of the J1-axis is limited.
 *3: This is the value at the surface of the mechanical interface when all axes are composited.
 *4: The cycle time is based on back-and-forth movement over a vertical distance of 25 mm and horizontal distance of 300 mm when the load is 1 kg.
 *5: The maximum load capacity indicates the maximum payload when the mechanical interface is facing downward (±10° to the perpendicular).



Vertical
4 kg
type

RV-4F
RV-4FL

External Dimensions/Operating Range Diagram

RV-4F

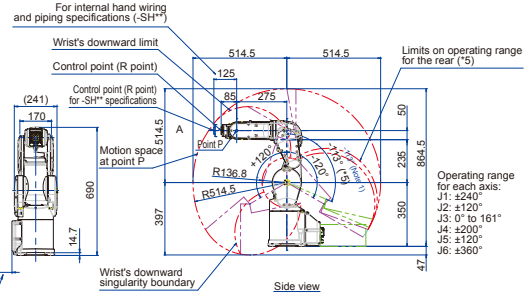
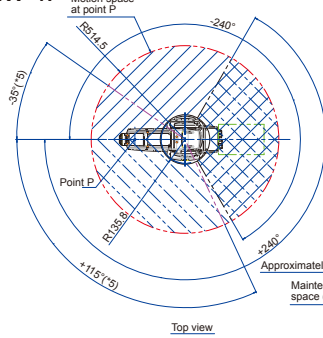

Intersection

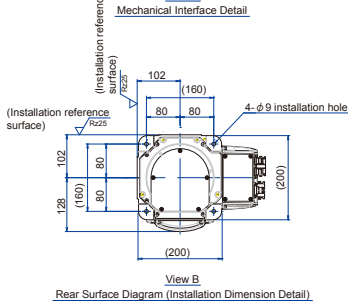
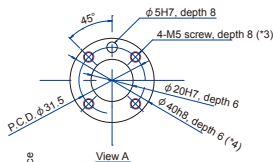

RV-4FL

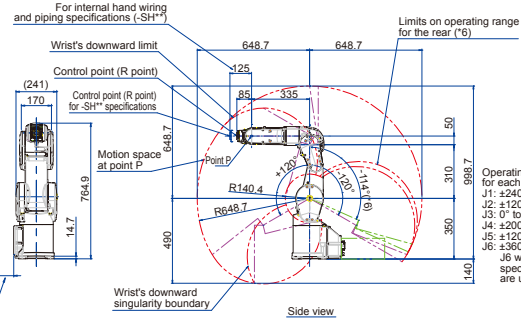
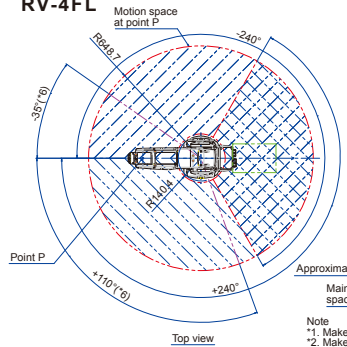

- Note
- *1. Make sure to leave enough space open for cable connections between devices.
 - *2. Make sure to leave enough space open for removing and attaching covers during maintenance work.
 - *3. Specify a thread engagement length of 7.5 to 8 mm.
 - *4. The depth of the $\phi 40$ -mm section is 3.5 mm for Clean/Mist models and 6 mm for Standard.
 - *5. The operating range for the J2 axis when $-35^\circ \leq J1 \leq +115^\circ$ is limited to $-113^\circ \leq J2 \leq +120^\circ$.
 - *6. The operating range for the J2 axis when $-35^\circ \leq J1 \leq +110^\circ$ is limited to $-114^\circ \leq J2 \leq +120^\circ$.
 - *7. The posture shown in the diagram results from when the robot axis angles are set as listed.
J1 = 0° , J2 = 0° , J3 = 90° , J4 = 0° , J5 = 0° , J6 = 0°

Specifications

Type	Unit	RV-4F(M)(C)	RV-4FL(M)(C)
Environmental specifications		Standard/ Oil mist/ Clean	
Protection degree		IP40 (standard) / IP67 (oil mist) *1/ ISOclass3 *7	
Installation		Floor type, ceiling type, (wall-mounted type *2)	
Structure		Vertical, multiple-joint type	
Degrees of freedom		6	
Drive system *1		AC servo motor	
Position detection method		Absolute encoder	
Maximum load capacity		4	
Arm length	NO1 arm	mm	240 + 270
Maximum reach radius		mm	515
Operating range	J1	deg	480 (± 240)
	J2		240 (-120 to +120)
	J3		161 (-0 to +161)
	J4		400 (± 200)
	J5		240 (-120 to +120)
	J6		720 (± 360)
Maximum speed	J1	deg/sec	450
	J2		450
	J3		300
	J4		540
	J5		623
	J6		720
Maximum composite speed *3		mm/sec	9027
Cycle time *4		sec	0.36
Position repeatability		mm	± 0.02
Ambient temperature		$^\circ\text{C}$	0 to 40
Mass		kg	39
Tolerable moment	J4	Nm	6.66
	J5		6.66
	J6		3.96
Tolerable amount of inertia	J4	kgm ²	0.2
	J5		0.2
	J6		0.1
Tool wiring		Hand: 8 input points/8 output points Signal cable for the multi-function hand and sensors LAN X 1 <100 BASE-TX> (8-pin) *5	
Tool pneumatic pipes		Primary: $\phi 6 \times 2$ Secondary: $\phi 4 \times 8$, $\phi 4 \times 4$ (from base portion to forearm)	
Machine cable		5m (connector on both ends)	
Connected controller *6		CR750, CR751	

*1: Please contact Mitsubishi Electric dealer since the environmental resistance may not be secured depending on the characteristics of oil you use. Air will need to be purged from the lines. For details, refer to the specifications sheet.
 *2: The wall-mounted specification is a custom specification where the operating range of the J1-axis is limited.
 *3: This is the value at the surface of the mechanical interface when all axes are composited.
 *4: The cycle time is based on back-and-forth movement over a vertical distance of 25 mm and horizontal distance of 300 mm when the load is 1 kg.
 *5: Can also be used as a spare line (0.2 sq. mm, 4-pair cable) for conventional models.
 *6: Select either controller according to your application. CR751-D: Standalone type, CR751-Q: iQ Platform compatible type.
 *7: Preservation of cleanliness levels depends on conditions of a downstream flow of 0.3 m/s in the clean room and internal robot suctioning. A $\phi 8$ -mm coupler for suctioning is provided at the back of the base.



Vertical
7 kg
type

RV-7F
RV-7FL

External Dimensions/Operating Range Diagram

2
Robot Specifications

Intersection

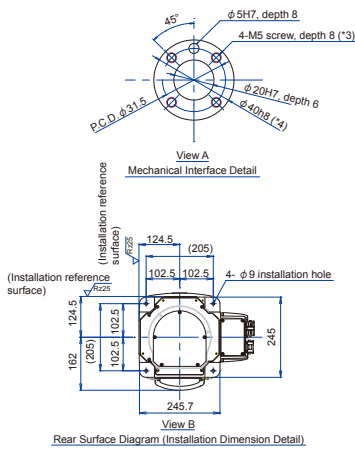

RV-7F

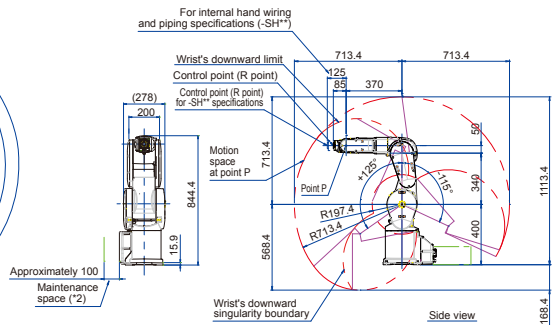
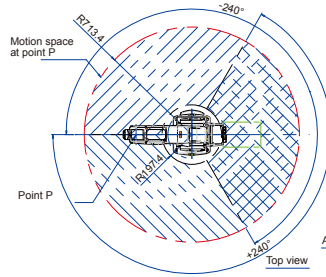

Operating range for each axis:
J1: ±240°
J2: -115° to 125°
J3: 0° to 156°
J4: ±200°
J5: ±120°
J6: ±360°
J6 when -SH specifications are used: ±200°

RV-7FL

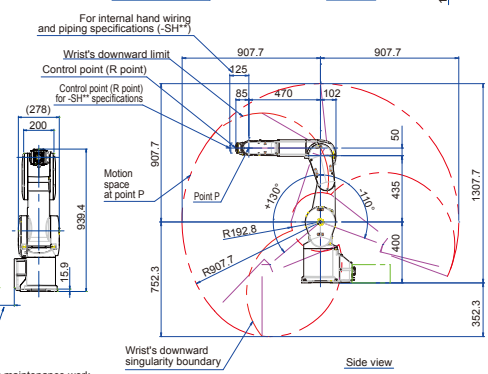
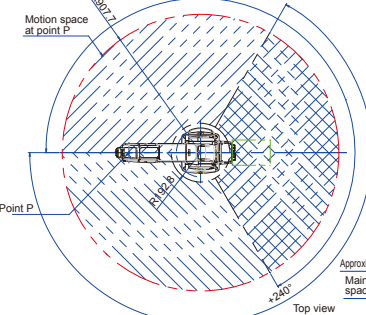

Operating range for each axis:
J1: ±240°
J2: -110° to 130°
J3: 0° to 162°
J4: ±200°
J5: ±120°
J6: ±360°
J6 when -SH specifications are used: ±200°

- Note
*1. Make sure to leave enough space open for cable connections between devices.
*2. Make sure to leave enough space open for removing and attaching covers during maintenance work.
*3. Specify a thread engagement length of 7.5 to 8 mm.
*4. The depth of the φ40-mm section is 3.5 mm for Clean/Mist models and 6 mm for Standard.
*5. The posture shown in the diagram results from when the robot axis angles are set as listed.
J1 = 0°, J2 = 0°, J3 = 90°, J4 = 0°, J5 = 0°, J6 = 0°

Specifications

Type	Unit	RV-7F(M)(C)	RV-7FL(M)(C)
Machine class		Standard/ Oil mist/ Clean	
Protection degree		IP40 (standard)/ IP67 (oil mist) *1/ ISOclass3 *7	
Installation		Floor type, ceiling type, (wall-mounted type *2)	
Structure		Vertical, multiple-joint type	
Degrees of freedom		6	
Drive system		AC servo motor	
Position detection method		Absolute encoder	
Maximum load capacity	kg	7	
Arm length	mm	340 + 370	435 + 470
Maximum reach radius	mm	713	908
Operating range	J1	480 (±240)	
	J2	240 (-115 to +125)	240 (-110 to +130)
	J3	156 (-0 to +156)	162 (-0 to +162)
	J4	400 (±200)	
	J5	240 (-120 to +120)	
	J6	720 (±360)	
Maximum speed	J1	360	288
	J2	401	321
	J3	450	360
	J4	337	337
	J5	450	450
	J6	720	720
Maximum composite speed *3	mm/sec	11064	10977
Cycle time *4	sec	0.32	0.35
Position repeatability	mm	±0.02	
Ambient temperature	°C	0 to 40	
Mass	kg	65	67
Tolerable moment	J4	16.2	
	J5	16.2	
	J6	6.86	
Tolerable amount of inertia	J4	0.45	
	J5	0.45	
	J6	0.10	
Tool wiring		Hand: 8 input points/8 output points (20 pins total) Serial signal cable for parallel I/O (2-pin + 2-pin power line) LAN X 1 <100 BASE-TX> (8-pin) *5	
Tool pneumatic pipes		Primary: φ6 x 2 Secondary: φ4 x 8, φ4 x 4 (from base portion to forearm)	
Machine cable		5m (connector on both ends)	
Connected controller		CR750, CR751	

*1: Please contact Mitsubishi Electric dealer since the environmental resistance may not be secured depending on the characteristics of oil you use. Air will need to be purged from the lines. For details, refer to the specifications sheet.
*2: The wall-mounted specification is a custom specification where the operating range of the J1-axis is limited.
*3: This is at the hand flange surface when all axes are composited.
*4: The cycle time is based on back-and-forth movement over a vertical distance of 25 mm and horizontal distance of 300 mm when the load is 1 kg.
*5: Can also be used as a spare line (0.2 sq. mm, 4-pair cable) for conventional models.
*6: Select either controller according to your application.
*7: Preservation of cleanliness levels depends on conditions of a downstream flow of 0.3 m/s in the clean room and internal robot suctioning. A φ8-mm coupler for suctioning is provided at the back of the base.



Vertical
7 kg
type

RV-7FLL

External Dimensions/Operating Range Diagram

2 Robot Specifications

Same for RV-7F/7FL/7FLL

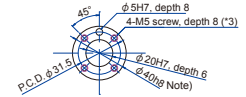

Note) The depth for the φ40 part is 3.5 mm (Oil mistclean), 6 mm (Standard), or 6.5 mm (-SH** models).

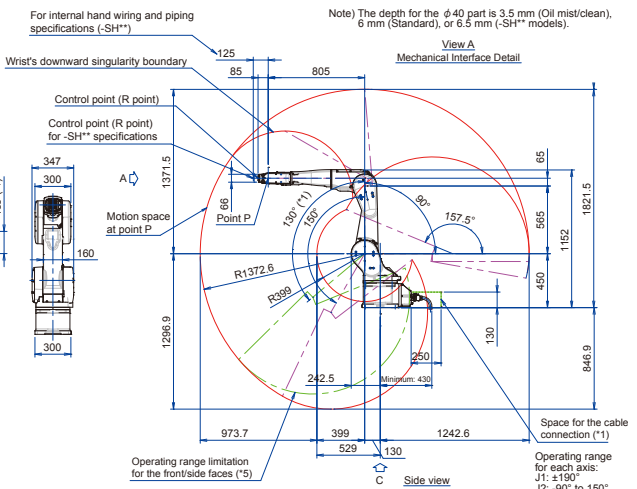
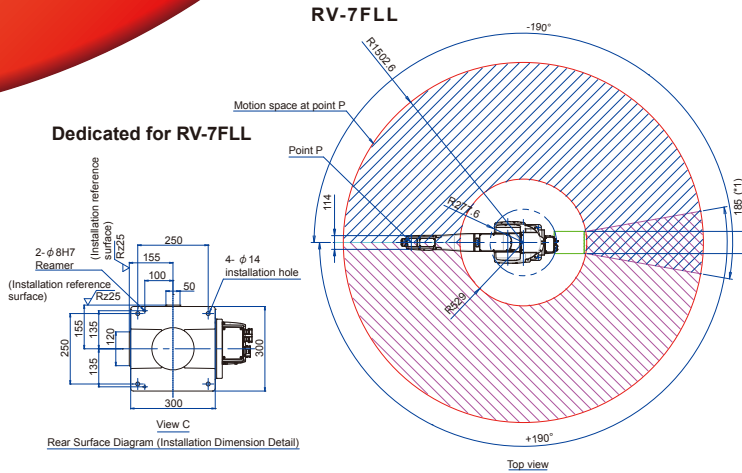

- *1. Make sure to leave enough space open for cable connections between devices.
- *2. Make sure to leave enough space open for removing and attaching covers during maintenance work.
- *3. Specify a thread engagement length of 7.5 to 8 mm.
- *4. Limits on the operating range for the front part: When the J1-axis angle is inside the range of +145° ≤ J1 ≤ +215° or -145° ≤ J1 ≤ -215°, the operating range of the J2-axis is limited to -110° ≤ J2 ≤ +120°.
- *5. Limits on the operating range for the front part: When the J1-axis angle is inside the range of J1 ≥ +120° or J1 ≤ -120°, the operating range of the J2-axis is limited to -90° ≤ J2 ≤ +130°.

Specifications

Type	Unit	RV-7FLL(M)(C)
Machine class		Standard/ Oil mist/ Clean
Protection degree		IP40 (standard)/ IP67 (oil mist) *1/ ISOclass3 *7
Installation		Floor type, ceiling type, (wall-mounted type *2)
Structure		Vertical, multiple-joint type
Degrees of freedom		6
Drive system		AC servo motor
Position detection method		Absolute encoder
Maximum load capacity	kg	Maximum: 7 (Rated: 7)
Arm length	NO1 arm mm	565 + 805
Maximum reach radius	mm	1503
Operating range	J1	380 (±190)
	J2	240 (-90 to +150)
	J3	167.5 (-10 to +157.5)
	J4	400 (±200)
	J5	240 (-120 to +120)
	J6	720 (±360)
Maximum speed	J1	234
	J2	164
	J3	219
	J4	375
	J5	450
	J6	720
Maximum composite speed *3	mm/sec	15300
Cycle time *4	sec	0.63
Position repeatability	mm	±0.06
Ambient temperature	°C	0 to 40
Mass	kg	130
Tolerable moment	J4	16.2
	J5	16.2
	J6	6.86
Tolerable amount of inertia	J4	0.45
	J5	0.45
	J6	0.10
Tool wiring		Hand: 8 input points/8 output points (20 pins total) Serial signal cable for parallel I/O (2-pin + 2-pin power line) LAN X 1 <100 BASE-TX> (8-pin) *5
Tool pneumatic pipes		Primary: φ6 x 2 Secondary: φ4 x 8, φ4 x 4 (With wrist attached)
Machine cable		7m (connector on both ends)
Connected controller		CR750, CR751

*1: Please contact Mitsubishi Electric dealer since the environmental resistance may not be secured depending on the characteristics of oil you use.
 *2: The wall-mounted specification is a custom specification where the operating range of the J1-axis is limited.
 *3: This is the value at the surface of the mechanical interface when all axes are composited.
 *4: The cycle time is based on back-and-forth movement over a vertical distance of 25 mm and horizontal distance of 300 mm when the load is 1 kg.
 *5: Can also be used as a spare line (0.13 sq. mm, 4-pair cable) for conventional models. Provided up to the inside of the forearm.
 *6: Select either controller according to your application.
 *7: Preservation of cleanliness levels depends on conditions of a downstream flow of 0.3 m/s in the clean room and internal robot suctioning. A φ8-mm coupler for suctioning is provided at the back of the base.



Vertical
13kg
type

RV-13F RV-13FL

External Dimensions/Operating Range Diagram

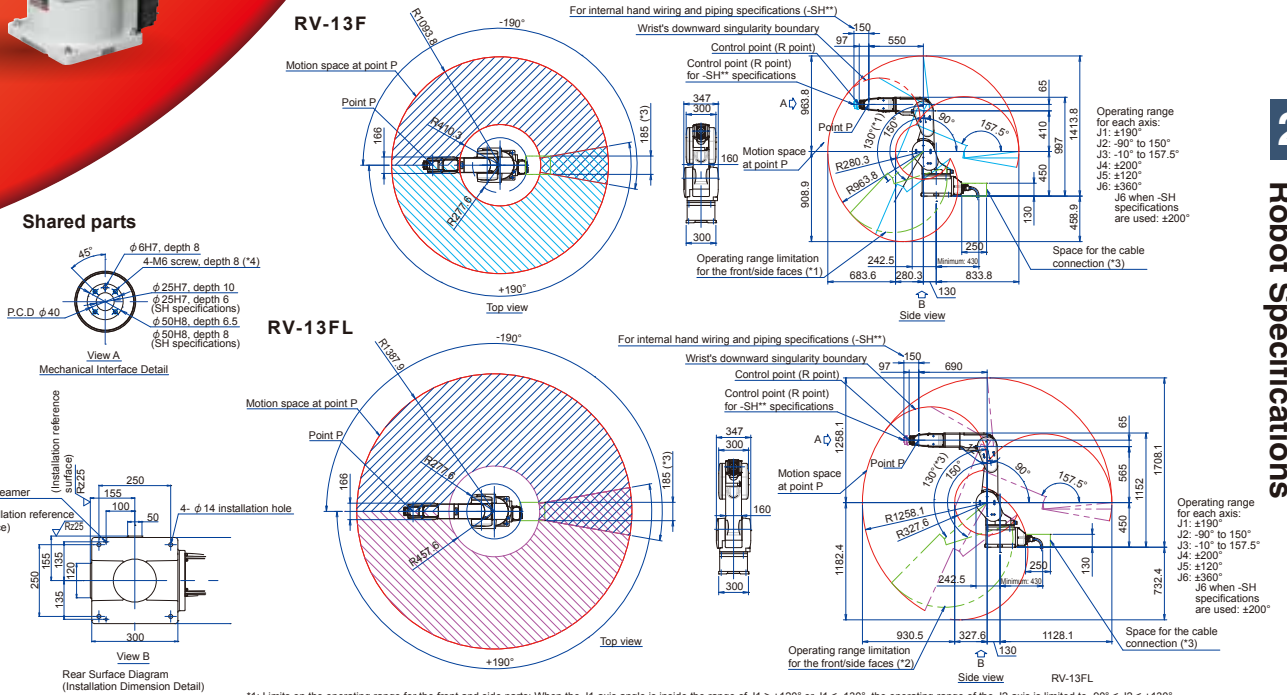

2 Robot Specifications

Specifications

*1: Limits on the operating range for the front and side parts: When the J1-axis angle is inside the range of J1 ≥ +120° or J1 ≤ -130°, the operating range of the J2-axis is limited to -90° ≤ J2 ≤ +130°.
 *2: Limits on the operating range for the front part: When the J1-axis angle is inside the range of J1 ≥ +130° or J1 ≤ -140°, the operating range of the J2-axis is limited to -90° ≤ J2 ≤ +130°.
 *3: Make sure to leave enough space open for cable connections between devices.
 *4: Specify a thread engagement length of 10 to 9 mm.

Type	Unit	RV-13F(M)(C)	RV-13FL(M)(C)
Machine class		Standard/ Oil mist/ Clean	
Protection degree		IP40 (standard)/ IP67 (oil mist) *1/ ISOclass3 *7	
Installation		Floor type, ceiling type, (wall-mounted type) *2	
Structure		Vertical, multiple-joint type	
Degrees of freedom		6	
Drive system		AC servo motor	
Position detection method		Absolute encoder	
Maximum load capacity	kg	Maximum: 13 (Rated: 12) *8	
Arm length	mm	410 + 550	565 + 690
Maximum reach radius	mm	1094	1388
Operating range	J1	380(±190)	
	J2	240 (-90 to +150)	
	J3	167.5 (-10 to +157.5)	
	J4	400 (±200)	
	J5	240 (-120 to +120)	
	J6	720 (±360)	
Maximum speed	J1	290	234
	J2	234	164
	J3	312	219
	J4	375	375
	J5	375	375
	J6	720	720
Maximum composite speed *3	mm/sec	10450	9700
Cycle time *4	sec	0.53	0.68
Position repeatability	mm	±0.05	
Ambient temperature	°C	0 to 40	
Mass	kg	120	130
Tolerable moment	J4	19.3	
	J5	19.3	
	J6	11	
Tolerable amount of inertia	J4	0.47	
	J5	0.47	
	J6	0.14	
Tool wiring		Hand: 8 input points/8 output points (20 pins total) Serial signal cable for parallel I/O (2-pin + 2-pin power line) LAN X 1 <100 BASE-TX> (8-pin) *5	
Tool pneumatic pipes		Primary: φ6 x 2 Secondary: φ4 x 8, φ4 x 4 (With wrist attached)	
Machine cable		7m (connector on both ends)	
Connected controller		CR750, CR751	

*1: Please contact Mitsubishi Electric dealer since the environmental resistance may not be secured depending on the characteristics of oil you use.
 *2: The wall-mounted specification is a custom specification where the operating range of the J1-axis is limited.
 *3: This is the value at the surface of the mechanical interface when all axes are composed.
 *4: The cycle time is based on back-and-forth movement over a vertical distance of 25 mm and horizontal distance of 300 mm when the load is 5 kg.
 *5: Can also be used as a spare line (0.13 sq. mm, 4-pair cable) for conventional models. Provided up to the inside of the forearm.
 *6: Select either controller according to your application.
 *7: Preservation of cleanliness levels depends on conditions of a downstream flow of 0.3 m/s in the clean room and internal robot suctioning. A φ8-mm coupler for suctioning is provided at the back of the base.
 *8: The maximum load capacity indicates the maximum payload when the mechanical interface is facing downward (±10° to the perpendicular).



Vertical
20 kg
type

RV-20F

External Dimensions/Operating Range Diagram

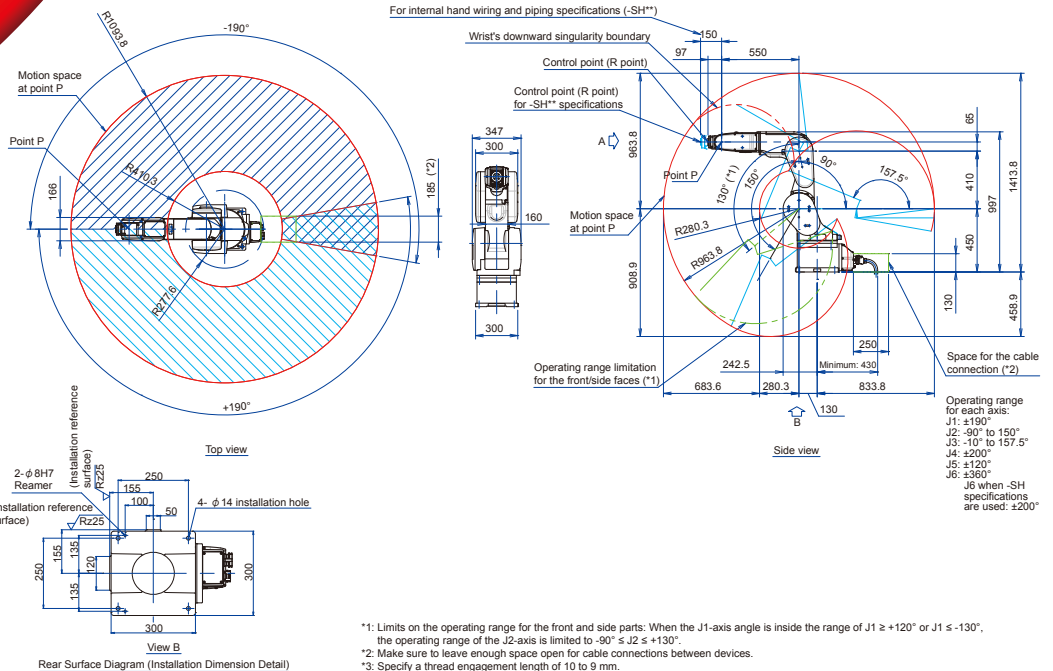

Specifications

Type	Unit	RV-20F(M)(C)
Machine class		Standard/ Oil mist/ Clean
Protection degree		IP40 (standard)/ IP67 (oil mist) *1/ ISOclass3 *7
Installation		Floor type, ceiling type, (wall-mounted type *2)
Structure		Vertical, multiple-joint type
Degrees of freedom		6
Drive system		AC servo motor
Position detection method		Absolute encoder
Maximum load capacity	kg	Maximum: 20 (Rated: 15) *8
Arm length	NO1 arm	mm
Maximum reach radius		mm
Operating range	J1	deg
	J2	deg
	J3	deg
	J4	deg
	J5	deg
	J6	deg
Maximum speed	J1	deg/sec
	J2	deg/sec
	J3	deg/sec
	J4	deg/sec
	J5	deg/sec
	J6	deg/sec
Maximum composite speed *3	mm/sec	
Cycle time *4	sec	
Position repeatability	mm	
Ambient temperature	°C	
Mass	kg	
Tolerable moment	J4	Nm
	J5	Nm
	J6	Nm
Tolerable amount of inertia	J4	kgm ²
	J5	kgm ²
	J6	kgm ²
Tool wiring		Hand: 8 input points/8 output points (20 pins total) Serial signal cable for parallel I/O (2-pin + 2-pin power line) LAN X 1 <100 BASE-TX> (8-pin) *5
Tool pneumatic pipes		Primary: φ6 x 2 Secondary: φ4 x 8, φ4 x 4 (With wrist attached)
Machine cable		7m (connector on both ends)
Connected controller		CR750, CR751

*1: Please contact Mitsubishi Electric dealer since the environmental resistance may not be secured depending on the characteristics of oil you use.
 *2: The wall-mounted specification is a custom specification where the operating range of the J1-axis is limited.
 *3: This is the value at the surface of the mechanical interface when all axes are composed.
 *4: The cycle time is based on back-and-forth movement over a vertical distance of 25 mm and horizontal distance of 300 mm when the load is 5 kg.
 *5: Can also be used as a spare line (0.13 sq. mm, 4-pair cable) for conventional models. Provided up to the inside of the forearm.
 *6: Select either controller according to your application.
 *7: Preservation of cleanliness levels depends on conditions of a downstream flow of 0.3 m/s in the clean room and internal robot suctioning. A φ8-mm coupler for suctioning is provided at the back of the base.
 *8: The maximum load capacity indicates the maximum payload when the mechanical interface is facing downward (±10° to the perpendicular).



Vertical
35/50/70
kg
type

RV-35F RV-50F RV-70F

Please contact your local representative or sales office.

External Dimensions/Operating Range Diagram

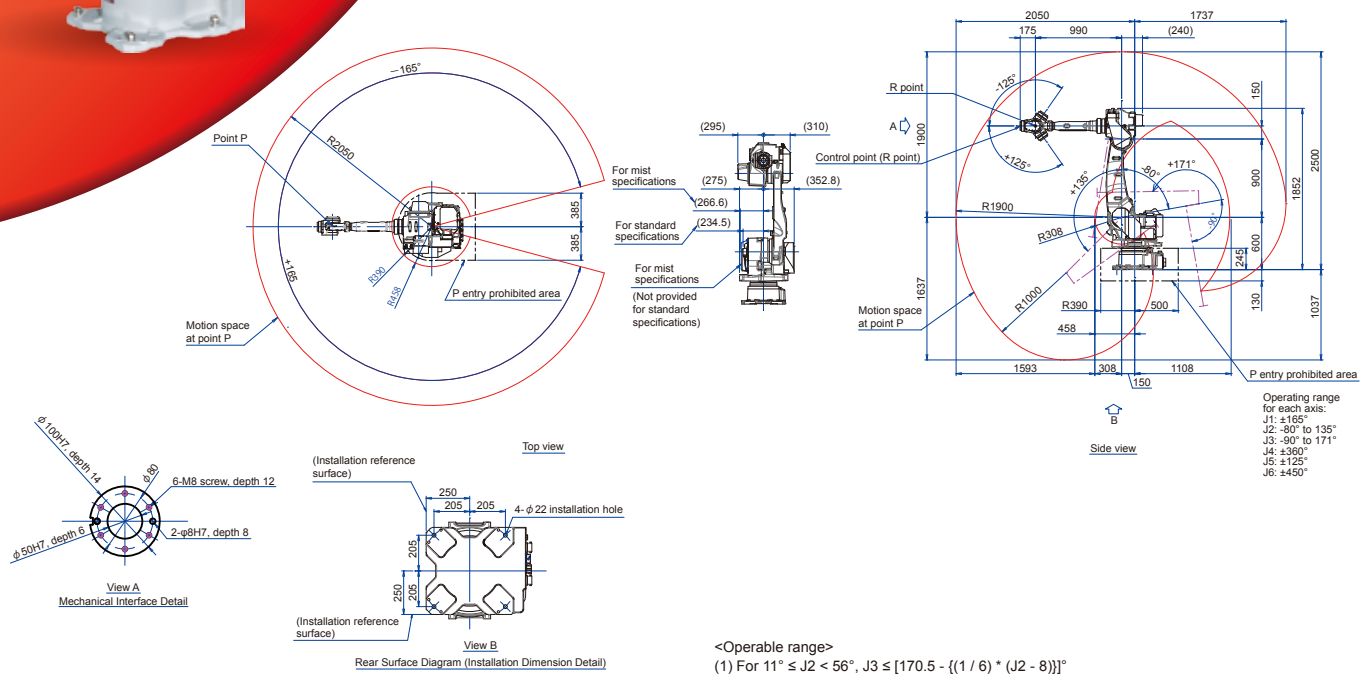

2
Robot Specifications

Specifications

- <Operable range>
 (1) For $11^\circ \leq J2 < 56^\circ$, $J3 \leq [170.5 - \{(1/6) * (J2 - 8)\}]^\circ$
 (2) For $J2 \geq 56^\circ$, the point P shall not enter the operable range limit area.
 (3) For $J3 \geq 162.5^\circ$, $J2 \leq 1031 - 6 * J3^\circ$
 (4) For $J2 \geq 130^\circ$, $J1 \leq 110^\circ$, or for $J1 > 110^\circ$, $J2 \leq 130^\circ$

Type	Unit	RV-35F(M)	RV-50F(M)	RV-70F(M)
Machine class			Standard/ Oil mist	
Protection degree			J1 to J4:IP40, J5 to J6:IP67 (standard)/ IP67 (oil mist) *1	
Installation			Floor type	
Structure			Vertical, multiple-joint type	
Degrees of freedom			6	
Drive system			AC servo motor	
Position detection method			Absolute encoder	
Maximum load capacity	kg	35	50	75
Arm length	mm		900 + 990	
Maximum reach radius	mm		2050	
Operating range	J1		330 (±165)	
	J2		215 (-90 to +135)	
	J3		261 (-90 to +171)	
	J4	deg	720 (±360)	
	J5		250 (±125)	
	J6		900 (±450)	
Maximum speed	J1	185	180	175
	J2		180	145
	J3	190	180	165
	J4	305	255	235
	J5	305	255	235
	J6	420	370	350
Maximum composite speed *3	mm/sec	13450	13000	11500
Position repeatability	mm		±0.07	
Ambient temperature	°C		0 to 40	
Mass	kg		640	
Tolerable moment	J4	160	210	300
	J5	160	210	300
	J6	90	130	150
Tolerable amount of inertia	J4	16		30
	J5	16		30
	J6	5		12
Tool wiring			Hand: 16 input points/16 output points LAN X 1	
Tool pneumatic pipes			φ 10 x 2	
Connected controller			CR760-D/Q	



Horizontal
6 kg
type

RH-6FH35 RH-6FH45 RH-6FH55

External Dimensions/Operating Range Diagram

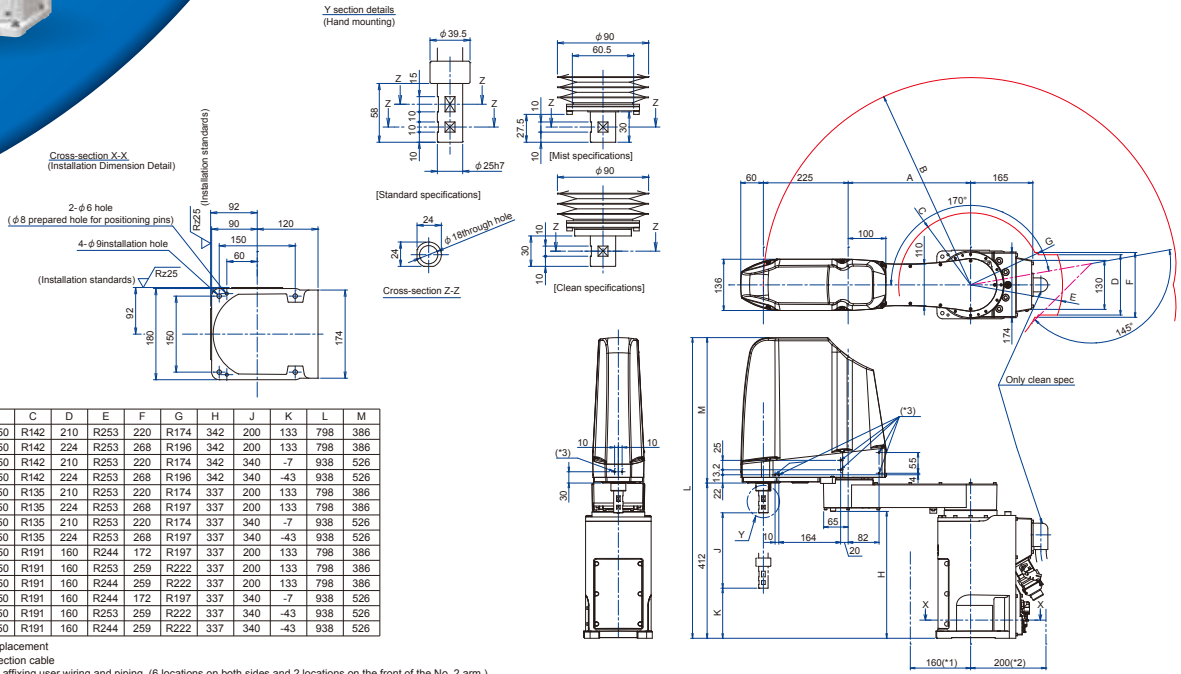

Variable dimensions

Robot series	A	B	C	D	E	F	G	H	J	K	L	M
RH-6FH3520	125	R350	R142	210	R253	220	R174	342	200	133	798	386
RH-6FH3520M/C	125	R350	R142	224	R253	268	R196	342	200	133	798	386
RH-6FH3534	125	R350	R142	210	R253	220	R174	342	340	-7	938	526
RH-6FH3534M/C	125	R350	R142	224	R253	268	R196	342	340	-43	938	526
RH-6FH4520	225	R450	R135	210	R253	220	R174	337	200	133	798	386
RH-6FH4520M/C	225	R450	R135	224	R253	268	R197	337	200	133	798	386
RH-6FH4534	225	R450	R135	210	R253	220	R174	337	340	-7	938	526
RH-6FH4534M/C	225	R450	R135	224	R253	268	R197	337	340	-43	938	526
RH-6FH5520	325	R550	R191	160	R244	172	R197	337	200	133	798	386
RH-6FH5520C	325	R550	R191	160	R253	259	R222	337	200	133	798	386
RH-6FH5520M	325	R550	R191	160	R244	259	R222	337	200	133	798	386
RH-6FH5534	325	R550	R191	160	R244	172	R197	337	340	-7	938	526
RH-6FH5534C	325	R550	R191	160	R253	259	R222	337	340	-43	938	526
RH-6FH5534M	325	R550	R191	160	R244	259	R222	337	340	-43	938	526

*1: Space required for the battery replacement
 *2: Space required for the interconnection cable
 *3: Screw holes (M4, 6 mm long) for affixing user wiring and piping. (6 locations on both sides and 2 locations on the front of the No. 2 arm.)

Specifications

Type	Unit	RH-6FH35XX/M/C	RH-6FH45XX/M/C	RH-6FH55XX/M/C
Machine class			Standard/ oil mist/ Clean	
Protection degree *1			IP20 *6/ IP65 *7/ ISO3 *8	
Installation			Floor type	
Structure			Horizontal, multiple-joint type	
Degrees of freedom			4	
Drive system			AC servo motor	
Position detection method			Absolute encoder	
Maximum load capacity	kg		Maximum 6 (rating 3)	
Arm length	NO1 arm	mm	125	225
	NO2 arm	mm		225
Maximum reach radius	mm	350	450	550
Operating range	J1	deg		340 (±170)
	J2	deg		290 (±145)
	J3 (Z)	mm		xx = 20 : 200/ xx = 34 : 340
	J4 (θ)	deg		720 (±360)
Maximum speed	J1	deg/sec		400
	J2	deg/sec		670
	J3 (Z)	mm/sec		2400
	J4 (θ)	deg/sec		2500
Maximum composite speed *2	mm/sec	6900	7600	8300
Cycle time *3			0.29	
Position repeatability	Y-X composite	mm	±0.010	±0.010
	J3 (Z)	mm		±0.01
	J4 (θ)	deg		±0.004
Ambient temperature			0 to 40	
Mass	kg	36	36	37
Tolerable amount of inertia	Rating	kgm ²		0.01
	Maximum	kgm ²		0.12
Tool wiring			Hand: 8 input points/8 output points (20 pins total) Serial signal cable for parallel I/O (2-pin + 2-pin power line) LAN X 1 <100 BASE-TX> (8-pin)) *4	
Tool pneumatic pipes			Primary: φ6 x 2 Secondary: φ4 x 8	
Machine cable			5m (connector on both ends)	
Connected controller *5			CR750, CR751	

*1: The range of vertical movement listed in the environmental resistance specifications (M: Oil mist specifications, C: Cleanroom specifications) for the RH-6FH is factory-set custom specifications.
 *2: The value assumes composition of J1, J2, and J4.
 *3: Value for a maximum load capacity of 2 kg. The cycle time may increase if specific requirements apply such as high work positioning accuracy, or depending on the operating position. (The cycle time is based on back-and-forth movement over a vertical distance of 25 mm and horizontal distance of 300 mm.)
 *4: Can also be used as a spare line (0.2 sq. mm, 4-pair cable) for conventional models.
 *5: Select either controller according to your application. Note that controllers with oil mist specifications come equipped with a controller protection box (CR750-MB) and "-SM" is appended at the end of the robot model name. If you require it, consult with the Mitsubishi Electric dealer.
 *6: IP54 rating for European models.
 *7: Please contact Mitsubishi Electric dealer since the environmental resistance may not be secured depending on the characteristics of oil you use. Direct jet to the bellows is excluded.
 *8: Preservation of cleanliness levels depends on conditions of a downstream flow of 0.3 m/s in the clean room and internal robot suctioning. A φ8-mm coupler for suctioning is provided at the back of the base.



Horizontal
12/20kg
type

RH-12FH55 RH-20FH85 RH-12FH70 RH-20FH100 RH-12FH85

External Dimensions/Operating Range Diagram

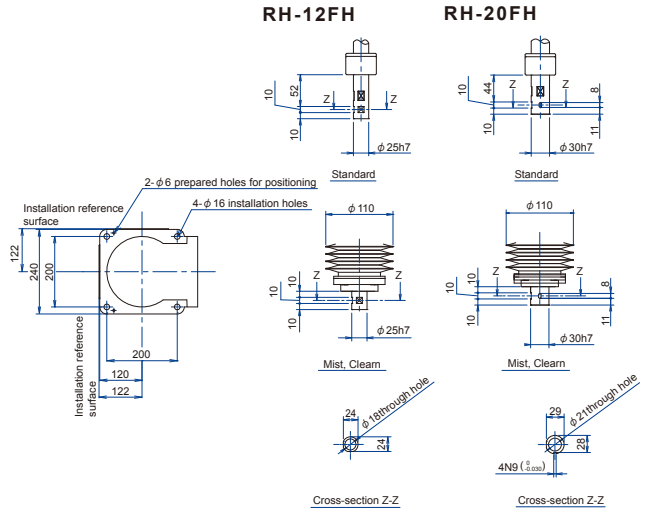
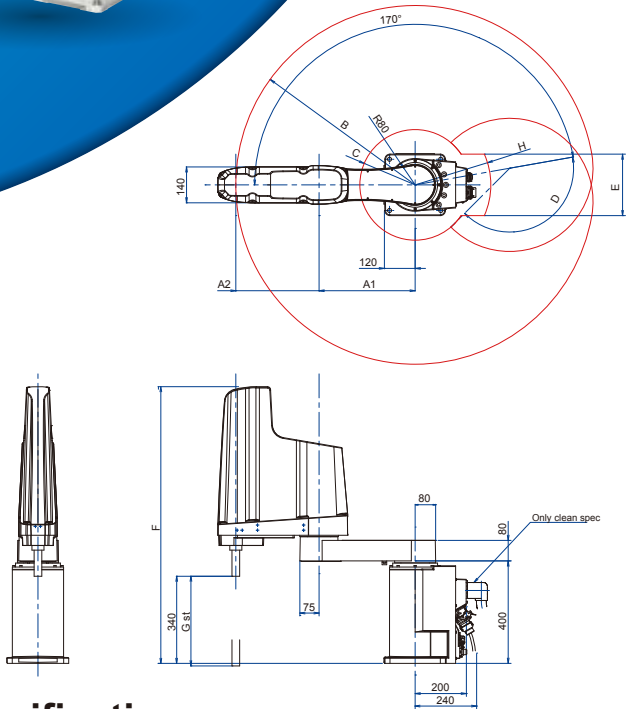

Variable dimensions

Robot series	A1	A2	B	C	D	E	F	G	H
RH-12FH55xx	225	325	R550	R191	145°	240	1080/1180	350/450	R295
RH-12FH55xx/MC	225	325	R550	R191	145°	320	1080/1180	350/450	R382
RH-12FH70xx	375	325	R700	R216	145°	240	1080/1180	350/450	R295
RH-12FH70xx/MC	375	325	R700	R216	145°	320	1080/1180	350/450	R382
RH-12FH20FH85xx	525	325	R850	R278	153°	-	1080/1180	350/450	-
RH-12FH20FH85xx/MC	525	325	R850	R278	153°	240	1080/1180	350/450	R367
RH-20FH100xx	525	475	R1000	R238	153°	240	1080/1180	350/450	R295
RH-20FH100xx/MC	525	475	R1000	R238	153°	320	1080/1180	350/450	R382

Specifications

Type	Unit	RH-12FH55XX/M/C	RH-12FH70XX/M/C	RH-12FH85XX/M/C	RH-20FH85XX/M/C	RH-20FH100XX/M/C
Machine class		Standard/ oil mist/ Clean			Standard/ oil mist/ Clean	
Protection degree *1		IP20/ IP65 *6/ ISO3 *7			IP20/ IP65 *6/ ISO3 *7	
Installation		Floor type			Floor type	
Structure		Horizontal, multiple-joint type				
Degrees of freedom		4				
Drive system		AC servo motor				
Position detection method		Absolute encoder				
Maximum load capacity	kg	Maximum 12 (rating 3)			Maximum 20 (rating 5)	
Arm length	NO1 arm	225	375	525	525	525
	NO2 arm		325		325	475
Maximum reach radius	mm	550	700	850	850	1000
Operating range	J1	340 (±170)				340 (±170)
	J2	290 (±145)			306 (±153)	306 (±153)
	J3 (Z)	xx = 35 : 350/ xx = 45 : 450				xx = 35 : 350/ xx = 45 : 450
	J4 (θ)	720 (±360)				720 (±360)
Maximum speed	J1	420			280	280
	J2	450			450	450
	J3 (Z)	2800			2400	2400
	J4 (θ)	2400			1700	1700
Maximum composite speed *2	mm/sec	11435	12535	11350	11372	13283
Cycle time *3		0.30	0.30	0.30	0.30	0.36
Position repeatability	Y-X composite	±0.012				
	J3 (Z)	±0.015			±0.015	±0.01
	J4 (θ)	±0.01				±0.01
Ambient temperature		±0.005				
Mass	kg	65	67	69	75	77
Tolerable amount of inertia	Rating	0.025				
	Maximum	0.3				
Tool wiring		Hand: 8 input points/8 output points (20 pins total) Serial signal cable for parallel I/O (2-pin + 2-pin power line) LAN X 1 <100 BASE-TX> (8-pin) *4				
Tool pneumatic pipes		Primary: φ6 x 2 Secondary: φ6 x 8				
Machine cable		5m (connector on both ends)				
Connected controller *5		CR750, CR751				

*1: The environment-resistant specifications (C: Clean specification, M: Mist specification) are factory-set custom specifications.

*2: The value assumes composition of J1, J2, and J4.

*3: Value for a maximum load capacity of 2 kg. The cycle time may increase if specific requirements apply such as high work positioning accuracy, or depending on the operating position. (The cycle time is based on back-and-forth movement over a vertical distance of 25 mm and horizontal distance of 300 mm.)

*4: Can also be used as a spare line (0.2 sq. mm, 4-pair cable) for conventional models.

*5: Select either controller according to your application. Note that controllers with oil mist specifications come equipped with a controller protection box (CR750-MB) and "-SM" is appended at the end of the robot model name. If you require it, consult with the Mitsubishi Electric dealer.

*6: Please contact Mitsubishi Electric dealer since the environmental resistance may not be secured depending on the characteristics of oil you use. Direct jet to the belows is excluded.

*7: Preservation of cleanliness levels depends on conditions of a downstream flow of 0.3 m/s in the clean room and internal robot suctioning. A φ8-mm coupler for suctioning is provided at the back of the base.



Horizontal
3 kg
type

RH-3FHR

External Dimensions/Operating Range Diagram

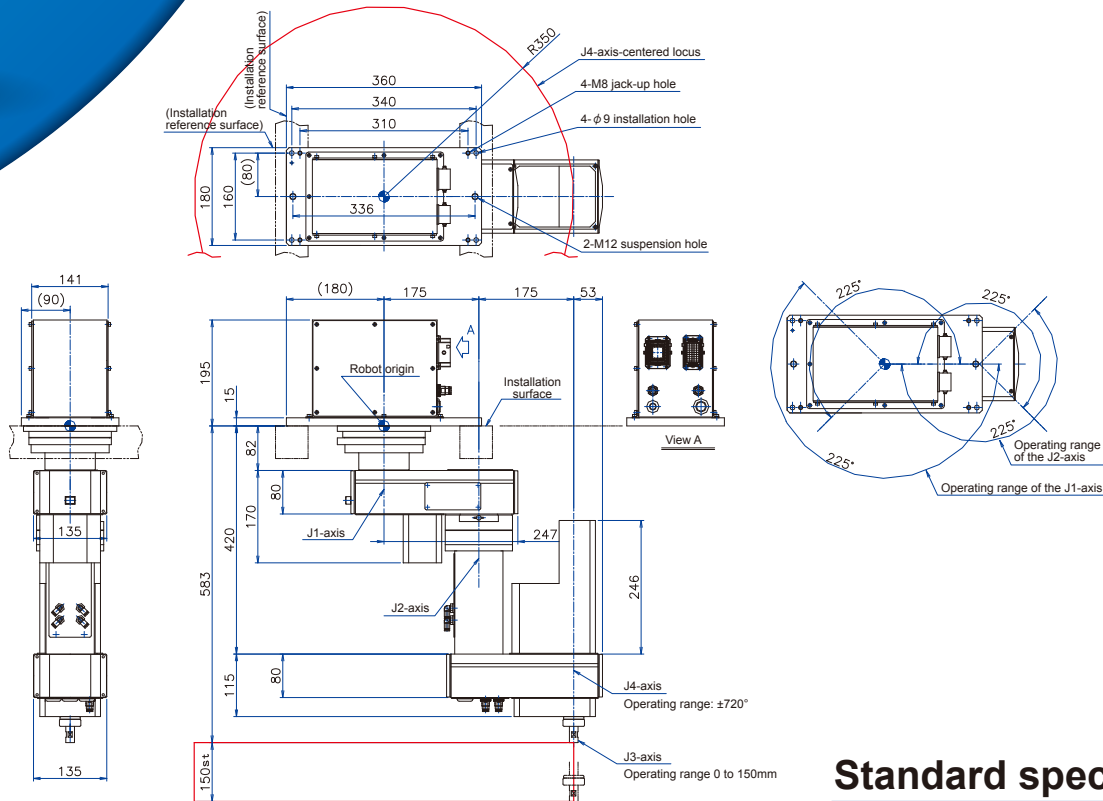

Standard spec

Specifications

Type	Unit	RH-3FHR3515	RH-3FHR3512C *1	RH-3FHR3512W *1
Machine class		Standard	Standard	Standard
Protection degree		IP20	ISOclass5 *5	IP65 *6
Installation Structure		Ceiling type		
Degrees of freedom		Horizontal, multiple-joint type		
Drive system		4		
Position detection method		AC servo motor (J1, J2 and J4: with no brake, J3: with brake)		
Maximum load capacity (rating)	kg	Absolute encoder		
Arm length	No. 1 arm	3 (1)		
	No. 2 arm	175		
Maximum reach radius (No. 1 + No. 2)	mm	175		
Operating range	J1	450 (±225)		
	J2	450 (±225)		
	J3 (Z)	150 (0 to 150)		
	J4 (θ)	1440 (±720)		
Maximum speed	J1	672		
	J2	708		
	J3 (Z)	1500		
	J4 (θ)	3146		
Maximum composite speed *2	mm/sec	6267		
Cycle time *3	sec	0.32		
Position repeatability	X-Y composite	±0.01		
	J3 (Z)	±0.01		
	J4 (θ)	±0.01		
Ambient temperature	°C	0 to 40		
Mass	kg	Approx. 24		
Tool wiring		Hand: 8 input points / 0 output points, 8 spare lines (8 output points by options)		
Tool pneumatic pipes		Primary: φ6 x 2 (Secondary: φ4 x 8)		
Machine cable		5m (connector on both ends)		
Connected controller		CR751 / CR750 *4		

*1: The environmental resistance specifications of RH-3FHR (C: Clean specification, W: Waterproof specification) are factory-set custom specifications.

*2: The value assumes composition of J1, J2, and J4.

*3: Based on a load capacity of 1 kg. The cycle time may increase if specific requirements apply such as high work positioning accuracy, or depending on the operating position. (The cycle time is based on back-and-forth movement over a vertical distance of 25 mm and horizontal distance of 300 mm.)

*4: Select either controller according to your application.

CR750-D/CR-751-Q: Standalone type, CR750-Q/CR751-Q: iQ Platform compatible type.

*5: Preservation of cleanliness levels depends on conditions of a downstream flow of 0.3 m/s in the clean room and internal robot suctioning. A φ8-mm coupler for suctioning is provided at the back of the base.

*6: Direct jet to the bellows is excluded.



Vertical
4/7/12/20
kg
type

Horizontal
6/12/20
kg
type

The environment-resistant specifications

(For medicinal products and foods)

The resistance to corrosion due to chemical cleaning is enhanced, and this improves detergency and cleanliness. These types of robots are applicable to the production environments including conveying or processing medicinal products and foods.

- **Enhanced resistance to acid and alkaline cleaning liquids**
 - Since special coating (compliant to FDA *1) and special sealing are applied to these types of robots, they can be used in an environment sterilized with hydrogen peroxide gas and withstand wipe cleaning with hydrogen peroxide water.
 - Stainless materials are used to enhance the corrosion resistance.
- **NSF H1 *2 -certified grease for food machinery**
The grease for food machinery is used to improve cleanliness.
- **Surface shape that prevents foreign matter from getting into and remaining inside**
Specially-shaped bolts and the smooth surface facilitate daily cleaning.

*1: Food and Drug Administration

*2: Sanitation guideline of NSF (National Sanitation Foundation) in the United States

Models

Vertical, multiple-joint type	Type	Chemical-resistant	H1 grease for food machinery
RV-4F series	RV-4FM RV-4FLM	-SE**01	-SE**02
RV-7F series	RV-7FM RV-7FLM RV-7FLLM		
RV-13F series	RV-13FM RV-13FLM		
RV-20F series	RV-20FM		
Horizontal, multiple-joint type	Type	Chemical-resistant	H1 grease for food machinery
RH-6FH series	RH-6FH35XXM RH-6FH45XXM RH-6FH55XXM	-SE**01	-SE**02
RH-12FH series	RH-12FH55XXM RH-12FH70XXM RH-12FH85XXM		
RH-20FH series	RH-20FH85XXM RH-20FH100XXM		

For the specifications of each model, refer to the specifications of each standard model. Note that these models have the following differences from the standard models. The protection degree of all the models is IP65.

Specifications

A NSF H1-certified grease is applied (Compliant to FDA)

H1 grease for food machinery is applied to joint oil seals. (Oil seals exposed to the external air)

B Stainless materials are used for robot tips

The tool flange of a robot tip is changed from a plated one to the one using stainless materials, and this enhances the corrosion resistance.



Stainless materials

C Special hexagon flange bolts are used (Cover-fixing bolts)

Liquid does not remain in the special bolts that are made of stainless-steel, and this improves detergency.

Grooving is performed to the bolts to enable easy cleaning the area around the cover-fixing bolts.

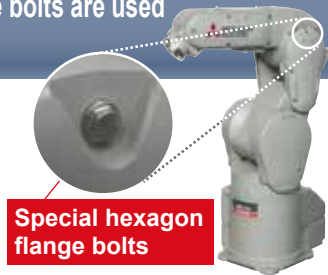

Special hexagon flange bolts

D Chemical-resistant coating to chassis (Compliant to FDA and the Food Sanitation Act)

Chemical-resistant special coating is applied to the arm.



Special coating (Compliant to FDA)

E Seals exposed to the external air are resistant to chemicals

Highly chemical-resistant rubbers are used for oil seals and packing, the seals exposed to the external environment, and this improves the detergency at food and pharmaceutical factories.

F The chemical resistance of bellows is improved (RH-F series only)

Fluorine resin is used for bellows, and this enhances the chemical resistance and improves the detergency at food and pharmaceutical factories.



Fluorine resin bellows

Correspondence table for environmental resistance specifications (for medicinal products and foods)

Specifications	Item	Chemical-resistant -SE**01 *3	H1 grease for food machinery -SE**02
A	H1 grease is applied to the seals exposed to the external air	○	○
B	Stainless materials are used for robot tips	○	○
C	Special hexagon flange bolts are used	○	○ (- : *4)
D	Chemical-resistant coating to chassis	○	-
E	Chemical-resistant seals	○	-
F	The chemical resistance of bellows is improved	○	-

RV - 13 F L M - 1D 1 - SE1501

Robot structure (Horizontal, multiple-joint type)
 Maximum load capacity *5
 Series *5
 Arm length *5

Special device No.
 SE1101: Chemical-resistant
 SE1102: H1 grease for food machinery
 SE1501: Chemical-resistant with CE
 SE1502: H1 grease for food machinery with CE
 1: CE specification

Controller type *5

Environment specification
 M: Oilmist specifications

RH - 20 FH 100 45 M - 1D 1 - SE1501

Robot structure (Horizontal, multiple-joint type)
 Maximum load capacity *5
 Series *5
 Arm length *5
 Vertical stroke *5

Special device No.
 SE1101: Chemical-resistant
 SE1102: H1 grease for food machinery
 SE1501: Chemical-resistant with CE
 SE1502: H1 grease for food machinery with CE
 1: CE specification

Controller type *5

Environment specification
 M: Oilmist specifications

*3: This model can be used in an environment sterilized with hydrogen peroxide gas (Concentration: 120ppm) and withstand wipe cleaning with hydrogen peroxide water (Concentration: 6%).

*4: Not apply for SE1102

*5: For the notations, refer to the standard models. (Refer page 4)

Controller

FQ series

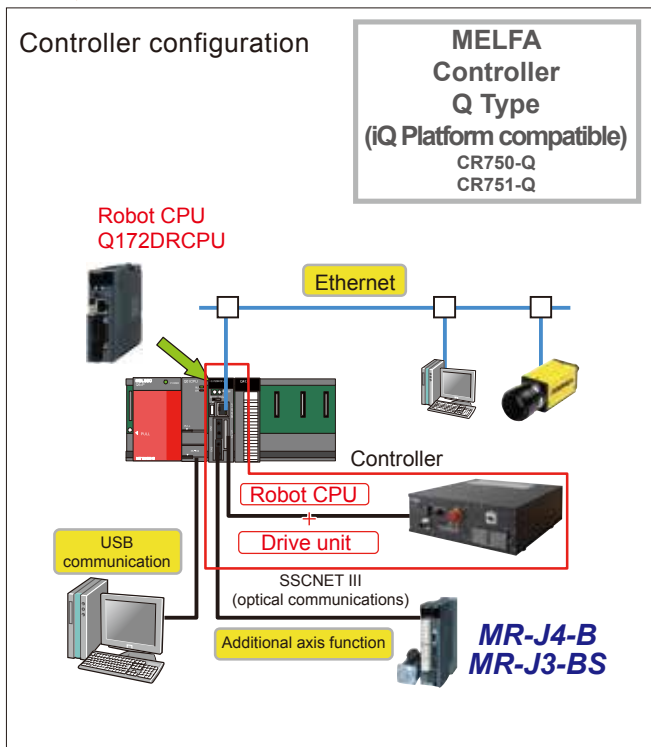

FD series

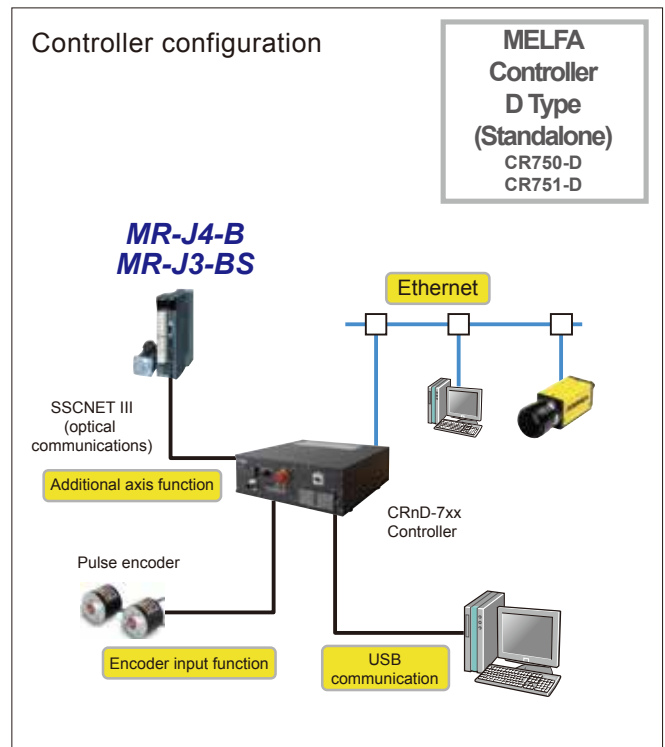

3

Controller Specifications

Specifications

Type	Unit	CR750-Q CR750-D	CR751-Q CR751-D
Robot CPU		FQ Q172DRCPU	
Path control method		PTP control and CP control	
Number of axes controlled		Maximum 6 axes	
Robot language		MELFA-BASIC IV/V	
Position teaching method		Teaching method, MDI method	
Memory capacity	Number of teaching points	points	FQ 13,000 / FD 39,000
	Number of steps	step	FQ 26,000 / FD 78,000
	Number of programs	Unit	FQ 256 / FD 512
External input/output *5	General-purpose I/O	points	FQ 8192 input points/8192 output points with the multiple CPU common device / FD 0 input/0 output (Up to 256/256 when options are used)
	Dedicated I/O		FQ Assigned to multiple CPU common device. / FD Assigned to general-purpose I/O.
	Hand open/close		8 input / 8 output
	Emergency stop input		1 (redundant)
	Door switch input		1 (redundant)
	Enabling device input		1 (redundant)
	Emergency stop output		1 (redundant)
	Mode output		1 (redundant)
	Robot error output		1 (redundant)
	Synchronization of additional axes		1 (redundant)
Interface	RS-232	ports	—
	RS-422		1 (Teaching pendant: dedicated T/B)
	Ethernet		FQ 1 (dedicated teaching pendant port) 10BASE-T / FD 1 (dedicated teaching pendant port), 1 (for customer) 10BASE-T/100BASE-TX
	USB		FQ 1 (USB port of programmable controller CPU unit can be used.) / FD 1 (Ver. 2.0 device functions only, mini B terminal)
	Additional-axis interface	channels	1 (SSCNET III)
	Extension slot *1	slots	FQ — / FD 2
	Encoder input	channels	FQ Q173DPX (Sold separately) / FD 2
Memory extension slot	slots	—	
Ambient temperature	°C	FQ 0 to 40 (drive unit)/0 to 55 (Robot CPU) / FD 0 to 40	
Relative humidity	%RH	45 to 85	
Power supply *5	Input voltage range *2	V	RV-2F/4F, RH-3FH/6FH: Single-phase AC 180 V to 253 V RV-7, 7FLL/13F/20F, RH-12FH/20FH: Three-phase AC 180 V to 253 V or Single-phase AC 207 V to 253 V
	Power capacity *3	KVA	RV-2F, RH-3FH : 0.5 RV-4F, RH-6FH : 1.0 RH-12FH/20FH : 1.5 RV-7F : 2.0 RV-7FLL/13F/20F : 3.0
External dimensions (including legs)	mm	430 (W) x 425 (D) x 174 (H)	430 (W) x 425 (D) x 98 (H) / 430 (W) x 425 (D) x 174 (H) *6
Weight	kg	Approx. 18	Approx. 12 / Approx. 18 *6
Structure [protective specification]		Self-contained floor type/open structure (Vertical and horizontal position can be placed) [IP20]	
Grounding *4	Ω	100 or less (class D grounding)	

*1: For installing option interface.
 *2: The rate of power-supply voltage fluctuation is within 10%.
 *3: The power capacity indicates the rating for normal operation. Take note that the power capacity does not include the current being input when the power is turned on. The power capacity is only a rough guide and whether or not operation can be guaranteed depends on the input power-supply voltage.
 *4: Grounding works are the customer's responsibility.
 *5: For CR751, crimp or solder wiring for connection to user wiring connectors for emergency stop input/output, door switch input, etc. and power supply connectors. The optional terminal block replacement tool available separately can also be used to connect wiring.
 *6: For RV-7FLL/13F/20F

Multiple CPU environment



Unit	Type
Base	High-speed standard base between multiple CPU • Q35DB: 5 slots • Q38DB: 8 slots • Q312DB: 12 slots
Power supply	• Q61P • Q62P • Q63P • Q64PN
Programmable controller CPU	Universal model • Q03UD (E/V) CPU • Q04UD (E/V) HCPU • Q06UD (E/V) HCPU • Q10UD (E) HCPU • Q13UD (E/V) HCPU • Q20UD (E) HCPU • Q26UD (E/V) HCPU • Q100UD (E) HCPU

Drive unit **CR750-Q**
 Controller **CR750-D**

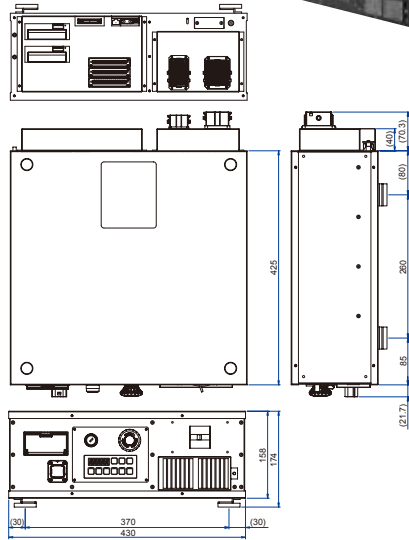

Drive unit **CR751-Q**
 Controller **CR751-D**
 (RH, RV-2F/4F/7F)

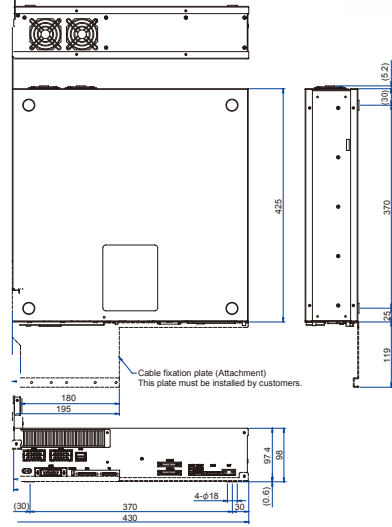

(RV-7FLL/13F/20F)

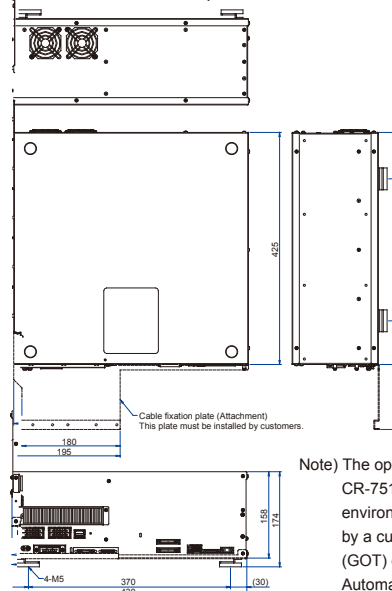

Note) The operating panel is not attached to the CR-751. Set up the robot operating environment to accommodate operation by a customer graphical optical terminal (GOT) or operating panel. Automatic and other operation modes can be enabled from the teaching pendant.

CR760-Q CR760-D
FC Q172DRCPU / FD Built-in
6 axes + additional 8 axes available
13,000
26,000
256
0 input/0 output
Assigned to general-purpose I/O.
16 input / 16 output
FC 1 / FD Use the function of the programmable controller.
FC Use the function of the programmable controller. / FD 1
FC Use the option of the programmable controller. / FD 3
FC Use the option of the programmable controller. / FD 2
FC — / FD 1
0 to 40
RV-35F/50F/70F: Three-phase AC 180 V to 253 V
RV-35F/50F/70F: Maximum : 20
670 (W) x 415 (D) x 700 (H)
Approx. 120
Self-contained floor type/sealed structure [IP54]

Controller protection box (IP54)

CR750-MB/CR751-MB

CR750-MB

The controller protection box is used to protect the controller from oil mist and other usage environments. (For CR750)

The front panel of the protection box has a mode switch and teaching box connector. It also contains a display window for viewing the controller operation panel.

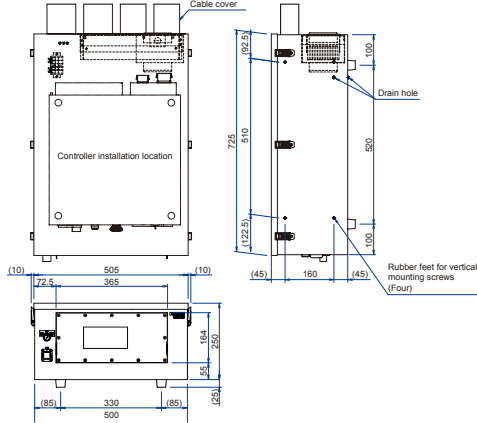

CR760-Q/CR760-D

CR760-Q

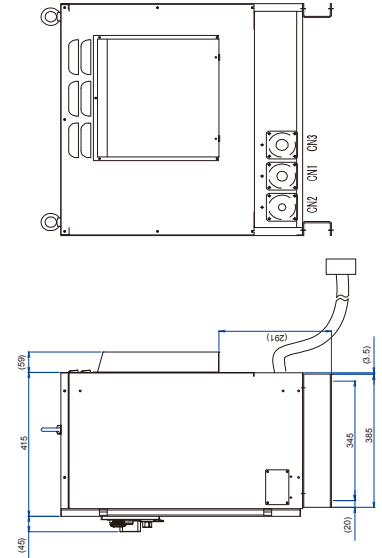
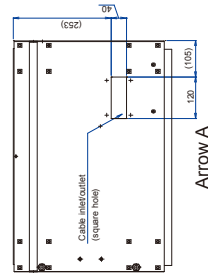

CR751-MB

The controller protection box is used to protect the controller from oil mist and other usage environments. (For CR751)

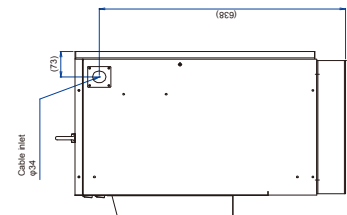
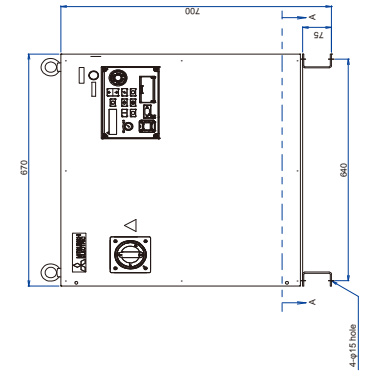
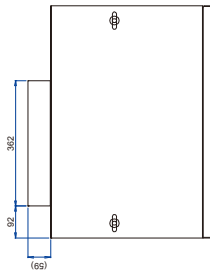
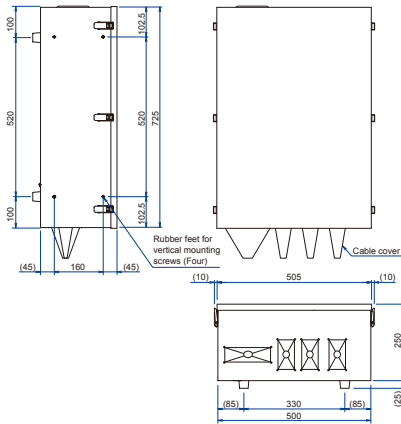

Functions

Increase through put

Improved control performance

Produced the fastest operating performance in its class using high-performance motors and unique driver control technology developed by Mitsubishi Electric.

- Enabled high torque output at high rotational speed, shortening acceleration/deceleration time.
- Shortened positioning time for improved device throughput.
- Continuous operability improved
- Improved speed for the vertical movements that are so essential to horizontal multi-joint robot operation. 2400 mm/s, [RH-6FH: Twice as fast as the conventional speed]

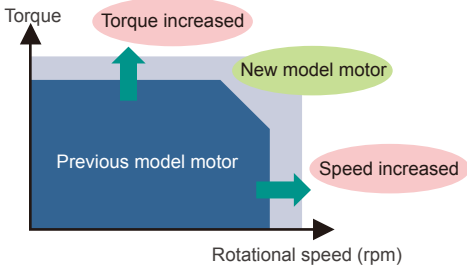

High-speed execution of programs

Enables execution up to 1.2 times faster than with the SQ/SD series. Numerical operation and conditional branch processing speeds increased by up to twice as fast, leading to shortened takt times.

Sample program

```

10 JOVRD 100
20 MOV P100
30 M1=M_IN (10)
40 IF M1=1 THEN GOTO 1000
50 IF M1=2 THEN GOTO 2000
60 IF M1=3 THEN GOTO 3000
70 MOV P999
80 ERROR 9000
90 END
1000 PL=P1*POFF*PSHIFT
1010 PUP=PL
1020 PUP.Z=PUP.Z+MZ
1030 MOV PUP

```

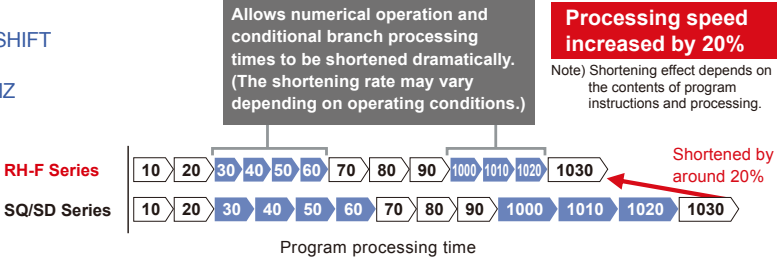

Robot programs can be executed 1.2 times faster than before if compiled in advance and processed using an intermediate language. Takt times can be shortened by up to 3 times as much for longer lines. (Compared to previous models)

Optimal acceleration/deceleration control and optimal override control

- Optimal acceleration/deceleration times and speeds set automatically based on robot operating position, posture, and load conditions.
- Load conditions are set, enabling acceleration/deceleration times and speeds to be changed automatically according to whether a workpiece is present or not.
- This enables the maximum operating speed to be produced for each task
- Time needed to shorten cycle times reduced.

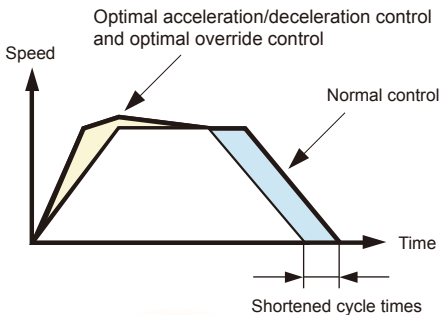

Improved continuous operability

Overload detection levels optimized based on the ambient temperature settings for the robot (set in the parameters). This helps improve continuous operability using load levels calculated based on actual environmental conditions for the robot axes.

The encoder temperature is monitored such that the machine is shut down due to error if the temperature exceeds the tolerable limit.

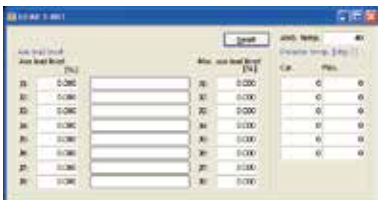

Encoder temperature monitoring screen

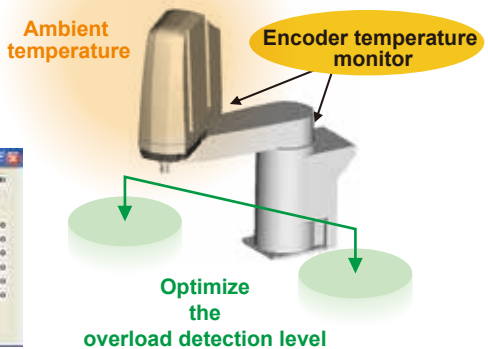

Functions

Improved tooling performance

Compatibility with internal Ethernet cable tools

Internal installation of wiring and piping for connecting to vision sensors enabled.

- Hand: 8 input points/8 output points
- Ethernet cable for the vision sensor

• Attachment of the vision sensor to the wrist facilitates wiring.

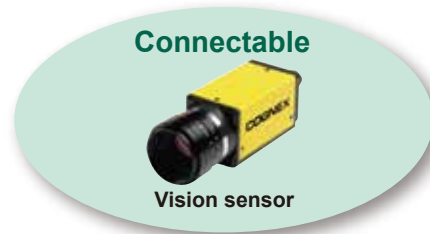

4

Functions

Internal routing of hand wiring and wiring channels

Internal routing of cables and air hoses is enabled through the internal channels that lead up to the end of the robot arm.

Such internal routing increases the areas of the work envelope that the robot can reach without twisting and entangling cables and hoses.

This prevents interference with cables around devices and reduces the risk of wiring disconnection.

Internal routing of wiring and wiring channels enabled within the arm up to the J6 axis tip.

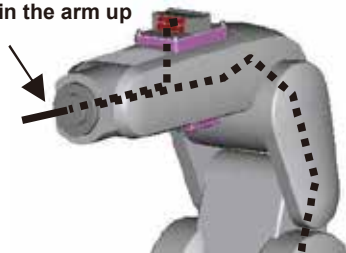

Note: Specify a model with Internal wiring (a model ending in '-SHxx').
The supported Internal wiring types may vary by model.

Note) The sections of wiring that can be routed internally may differ depending on the model.

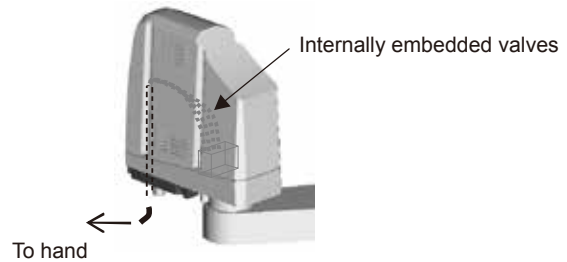

Space saving

Expanded pivotal operating range

Improved flexibility for robot layout design considerations.

Enabling more effective use of access space around the entire perimeter including to the rear.

Shortened movement distances, enabling takt times to be shortened.

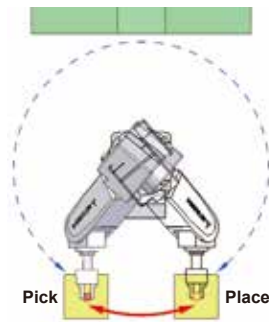
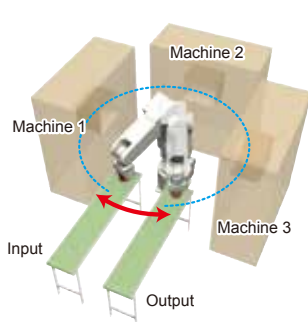

Movable stopper for the J1 axis

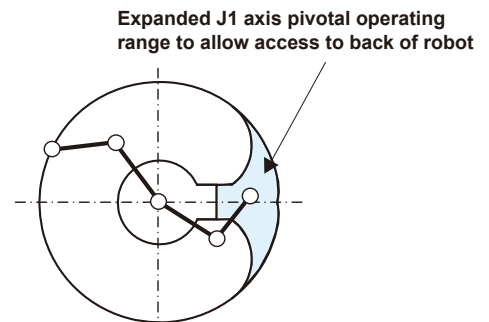

Rear access of RH-FQ/FD

RV-2FQ/2FD pivot operation

Improved accuracy

Active gain control

- Optimal motor control tuning set automatically based on robot operating position, posture, and load conditions.
- Improves tracking accuracy for the target trajectory.

· Active gain control is a control method that allows the position gain to be changed in real time.
 · This is effective for standard operations and tooling work requiring high accuracy.

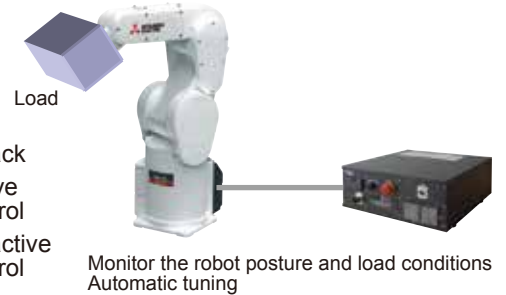
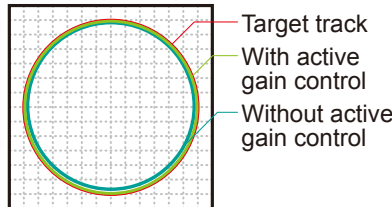

Operating mode setting function

- Trajectory priority mode/speed priority operation can be set in programs to match customer system requirements.
- Optimal motor control tuning set automatically based on robot operating position, posture, and load conditions.
- Improves tracking accuracy for the target trajectory.

· This is effective for standard operations and tooling work requiring high accuracy.

- Improve trajectory accuracy
- Improve vibration-damping performance

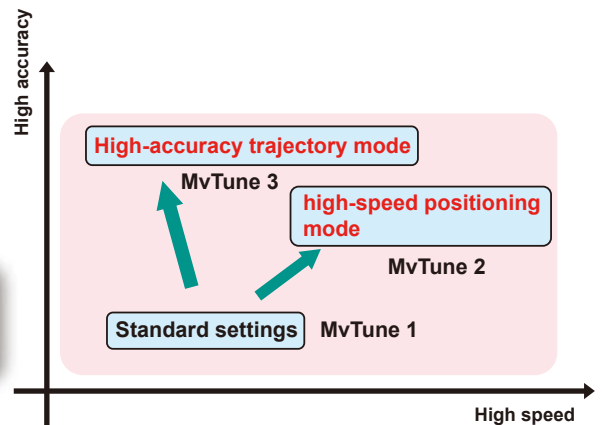

Deflection compensation function

- Compensates for deflection in the robot arm occurring due to gravity.
- Calculates the amount of compensation needed based on the operating position, posture, and load conditions of the robot and compensates for any deflection automatically.
- Compensates not only for static deflection due to gravitational pull but also for dynamic deflection due to the inertial force present during operation.

· Effective for work transporting workpieces to cassettes with low pitch and palletizing work.

- Improve palletization accuracy
- Improve trajectory accuracy

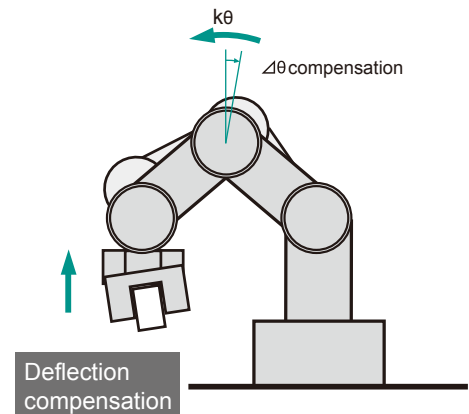

Functions

Simplified tool length setting

Tool settings for the tool coordinate system can be set by attaching the tool and using three to eight of the same teaching points. Enables settings to be made for the actual tool including errors introduced when the tool was made and other data without needing to calculate values from the tool diagram.

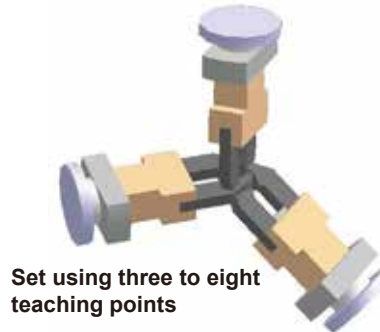
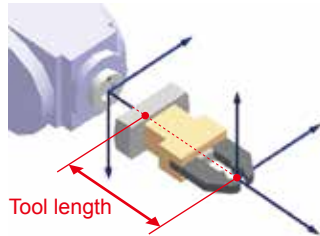

Set using three to eight teaching points

4

Functions

Adaptation to operation

Function for passing through the singular point

- The robot can be made to pass through the singular point, unlike with previous robot models. This allows for greater flexibility in the layout of robots and surrounding areas.
- Teaching operations can be performed more easily as there is no longer any need to cancel operations due to the presence of the singular point.

What a singular point is:

There is an unlimited number of angles at which the J4 and J6 axes can be set such that the angle of the J5 axis is 0° when linear interpolation operations are performed using position data from a joint coordinate system. This point is the singular point and is the point at which the robot cannot be operated at an assigned position and posture under normal conditions. The position at which this occurs is referred to as a singular point.

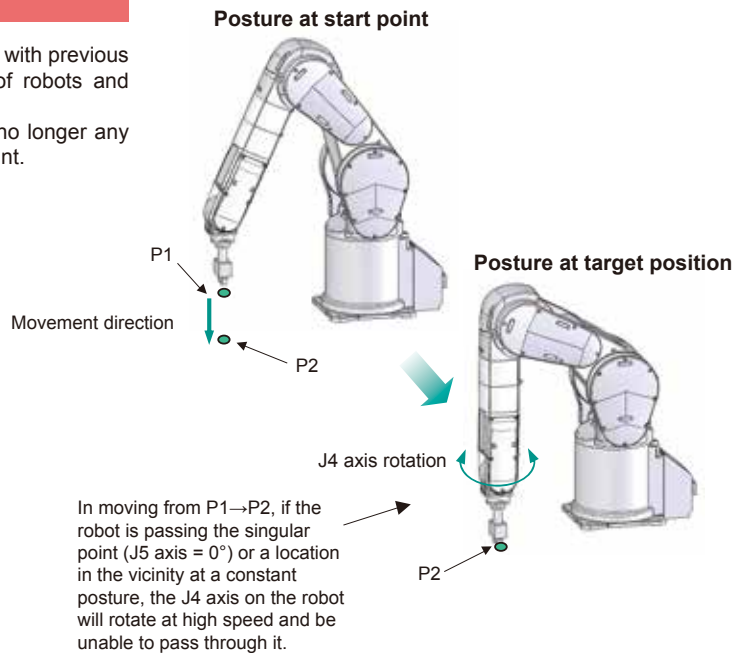

Orthogonal compliance control

- This function reduces the rigidity of the robot arm and tracks external forces. The robot itself is equipped with a compliance function, which makes special hands and sensors unnecessary.
- This allows the amount of force generated through interference during chucking and workpiece insertion to be reduced and external movement copying forces to be controlled.

- The compliance direction can be set arbitrarily using the robot coordinate system, the tool coordinate system, etc.
- This is useful in protecting against workpiece interference and cutting down on stoppage.

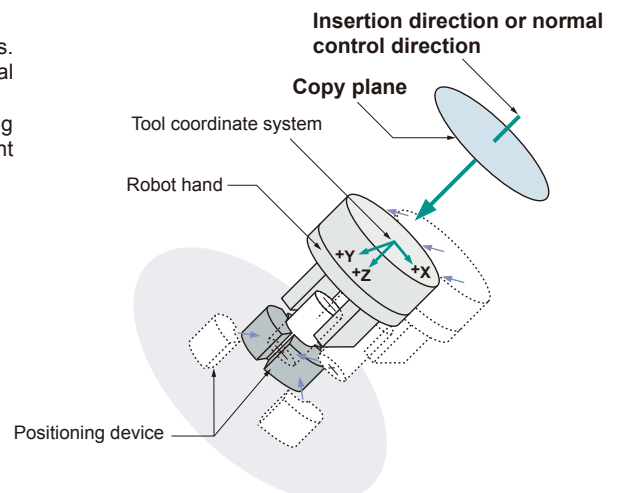

- Reduce tooling costs
- Shorten line stop times
- Shorten startup times

Improved user friendliness

Simple automatic operation from the teaching box

- Enables the robot to be controlled from the robot control screen using the same functions as on the operating panel of the robot controller.
- Monitoring screens can be set up individually to match the needs of user debugging conditions.

· Enabled for R32B/R33TB and R56TB/R57TB.

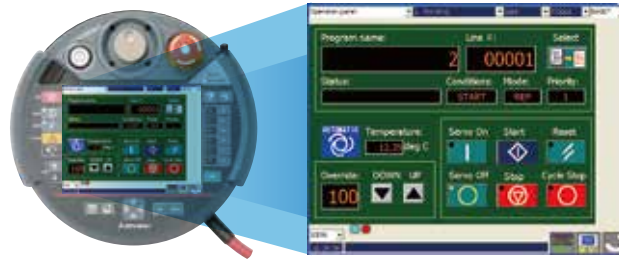

Robot control screen (R56TB)

Enables automatic operation of servo power on/off, startup, shutdown, reset, program selection, and other operations.

Enhanced RT ToolBox 2 visual functions

Enhanced RT ToolBox2 (PC software) graphic display function allowing setting parameters to be displayed visually. Visual confirmation using this function helps to proactively prevent setting errors.

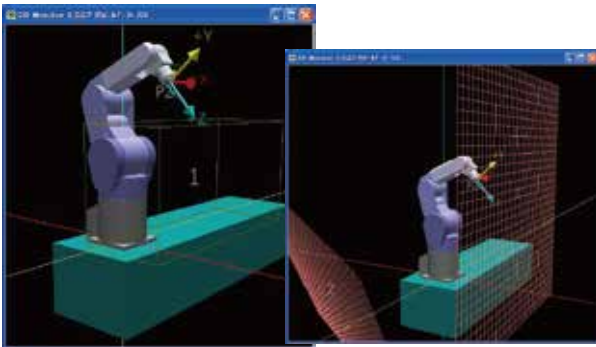

Display of user-defined regions/freedom-limited planes

Display of teaching positions and trajectories of end points helps to facilitate confirmation tasks during programming or simulations.

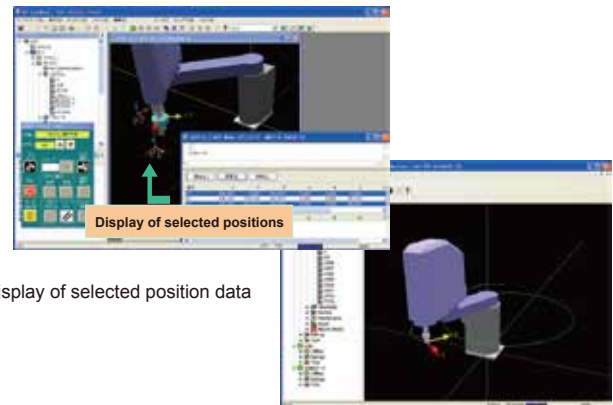

Display of selected position data

Display of trajectories

Hands can be created as combinations of basic diagrams on the Hand Editing screen and then attached to the robot. Standard 3D polygonal models (applicable 3D data file formats: STL, OBJ) can be imported into the program, allowing operators to confirm the relationship among the hands, workpieces, and peripheral devices during simulation.

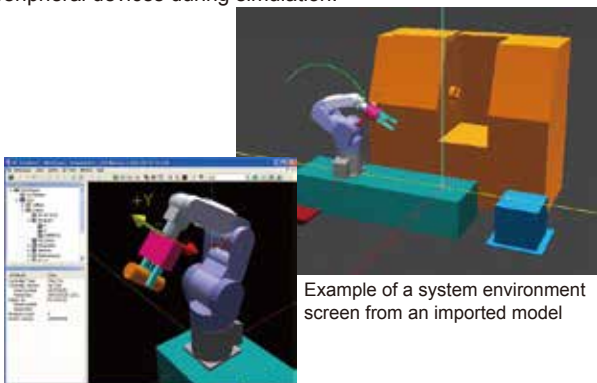

Example of a system environment screen from an imported model

Attachment of a hand created in RT ToolBox2

Up to 80000 records of data including current position, speed, axial loading, and sensor information can be obtained in every operating cycle of the robot and displayed in a graph. Execution rows and I/O signals are recorded and used for analyzing the robot status, and this improves the debug efficiency. The obtained data can be saved as an image (Bitmap) or in the CSV format.

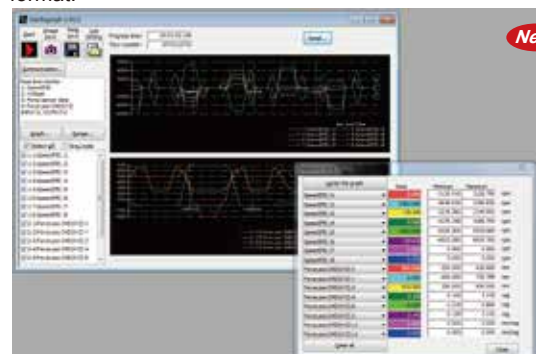

Oscillograph function (an example of the real-time monitoring of positions and current)

Functions

User-defined screen creation tools

Screens can be created anew, imported, or exported from "User-defined Screen Editing" in the project tree. Buttons, lamps, robot information, labels, and ruled lines can be arranged into layouts and assigned to robot variables.

Data created here is exported and loaded into the R56/57TB. Can be used as a user screen.

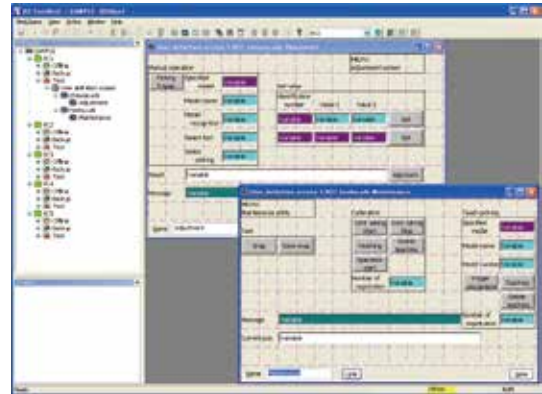

4

Linked to iQ Works

Functions

- Program management simplified
Enables batch management of programs and data in blocks from the programmable controller to the servo, display device, and robot.
- Device model selection simplified
All Mitsubishi device models are listed in the Navigator, enabling its use as a device model selection tool.
Ver. 1.24A and later is equipped with robot CPU selection capability and comes packaged with RT ToolBox2 (mini ver.).

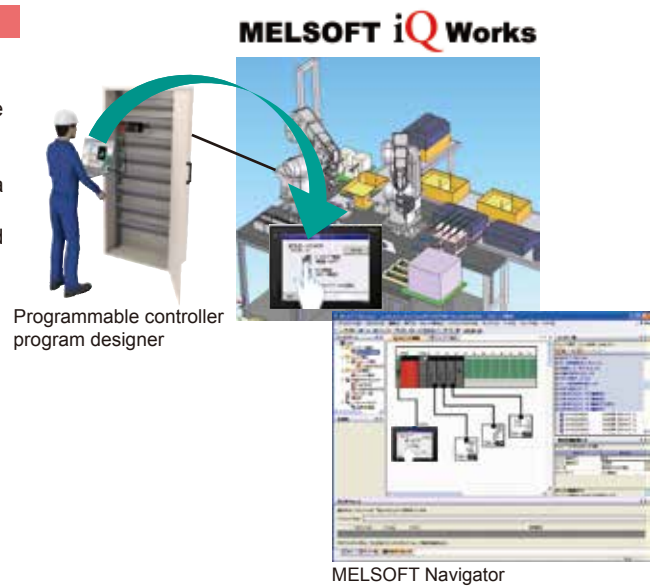

Programmable controller program designer

MELSOFT Navigator

GOT connection function

- The robot can be controlled directly from a Mitsubishi GOT 1000.
- Enables robot controller statuses to be uploaded and operations to be controlled directly from the GOT. Allows robot startup/shutdown, status/alarm monitoring, and other tasks to be completed from the GOT easily and quickly.
- Use of the transparent function enables editing of programs and parameters from the USB interface on the front GOT screen, improving user friendliness.

Operation of engineering tools from the USB interface on the front GOT screen.



[For Q type /D type controllers]

The personal computer and the GOT are connected with a USB cable or RS232 cable

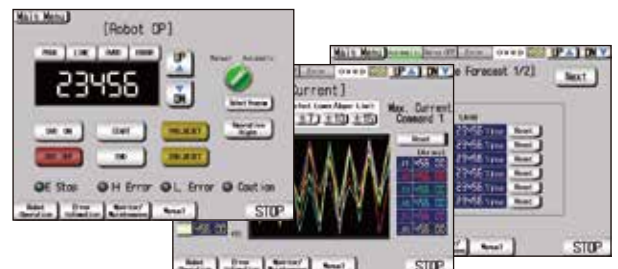

Example GOT screen

- Ethernet
- Serial signals etc.



[For Q type /D type controllers]

- Simplified control panel created using a GOT
- No need for ladder circuits with the GOT connection

* You can download a sample image from the Mitsubishi FA site.
(Sample data corresponds to the GT16, 640×480 or more)

Connection to peripheral devices

Vision sensor

- Simple settings
The robot and camera can be calibrated through a simple process using vision sensor setting tools.
- Simple connection
Simple connection between the robot and camera using Ethernet.
- Simple control
Simple control using vision control commands in the robot programs.
- Three robots connected to a single vision sensor/Seven vision sensors connected to a single robot
→ Enables costs to be reduced even for complicated system configurations.

- Reduce cycle time
- Reduce system costs

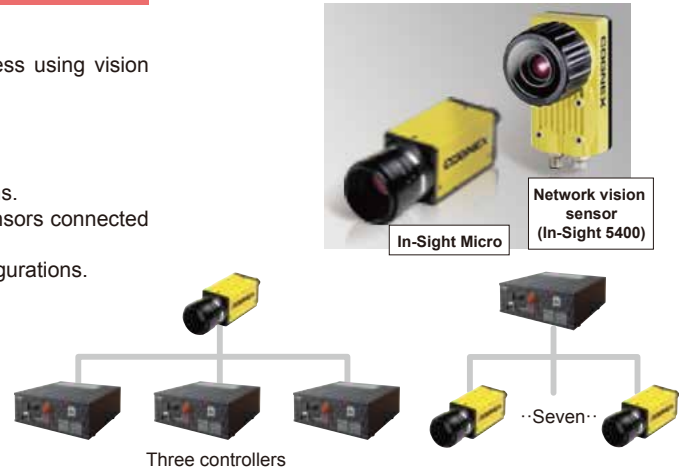

Tracking

- Transport, alignment, and installation work, etc. can be performed while robots are tracked with the workpiece on the conveyor without stopping the conveyor. Processing capability improved by up to 15% compared to that for SQ/SD series robots.
- Different variations can be selected, including vision tracking in combination with a vision sensor, tracking in combination with an opto-electric sensor, etc.
- Programs can be created easily in robot language (MELFA BASIC IV, V).
- Standard interface function. (D type only.) (Separate encoder and vision sensor required.)

- No need for a positioning device
- Reduce cycle time
- Reduce system costs

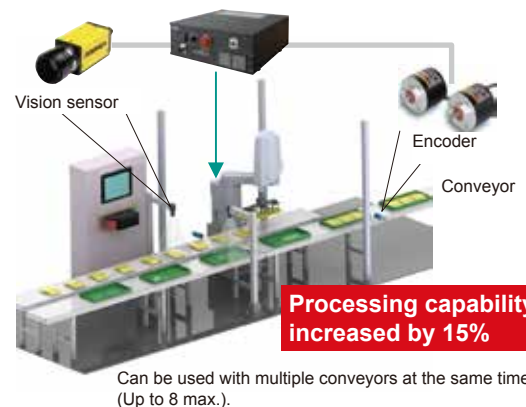

Additional axis function

- The layout can be set up to include the robot traveling axis and turntable as well as user machines separate from the robot such as loaders and positioning devices.
- Up to 8 additional axes can be controlled by the controller.
- Additional axes and user machines can be operated from the robot program and teaching pendant without any additional motion control hardware. The same JOG operation as for the robot can be used. Robot language can be used for control operations.
- The robot controller has plug-and-play compatibility with the MELSERVO (MR-J4-B, MR-J3-BS) servos.
- Standard interface function (Separate servo amplifier and servo motor required.)

- No need for a dedicated control device

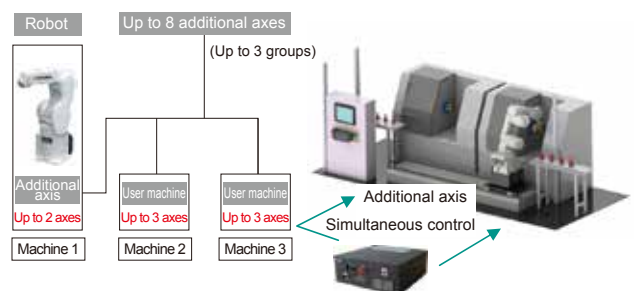

User interfaces

The various network options available allow connection to a variety of devices used throughout the world.

Standard equipment: Ethernet
USB
SSCNET III

Option: CC-Link
Profibus
DeviceNet
Network base card (EtherNet/IP, PROFINET IO)

Functions

Safety features

Security features

Security features were added to protect programs and parameters. Read/write protection prevents parameters from being overwritten and programs from being changed inadvertently. Sensitive data can be protected using password protection.

- Passwords can be set to protect created programs.
- The viewing and copying of data from the teaching pendant and RT ToolBox2 can be disabled.
- Writing operations for parameters can be disabled.

	Protected and restricted functions
Program-related	Reading and writing of programs Program deletion and copying Renaming and initialization of programs
Parameter-related	Writing of parameters
RT Tool Box2	Data backup and restore

4

Functions

Sustained tracking during emergency stop

The robot trajectory can be sustained even when the machine is shut down using an emergency stop. This allows interference with peripheral devices and other objects to be reduced or even fully prevented using the inertia of the robot arm to let it coast to a stop.

* Use of this function does not guarantee that the trajectory will be sustained. The trajectory may be shifted out of line depending on the timing at which the emergency stop is activated.

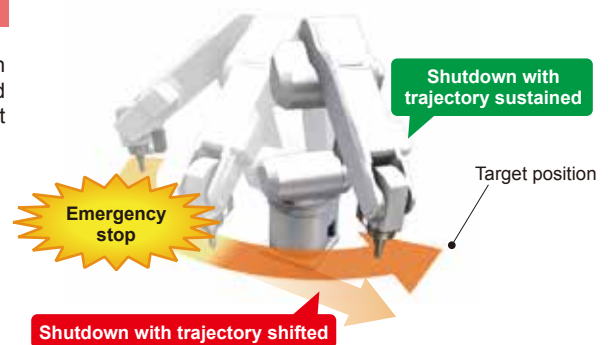

Collision detection function

- This function detects if the arm collides with an obstacle while teaching or operating, and helps reduce damage to the robot arm and tools.
- The collision detection function can be used to protect the workpiece from becoming damaged due to interference between the workpiece and affected objects.
- The detection level can be changed according to the protection targets.
- The collision detection function can be programmed to generate an alarm or perform a specific escape move or both.
Ex.) An error is output due to the robot stopping suddenly, an error is output after escape movements are made, etc.

- Reduce tooling costs
- Shorten line stop times
- Reduce maintenance costs

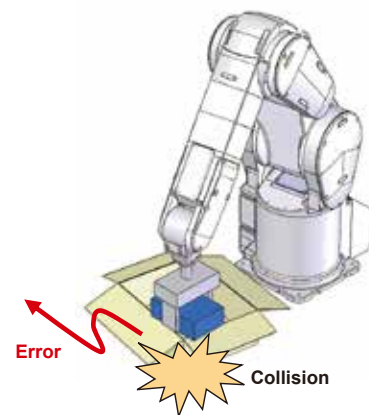

Complies with safety standards

Complies with the latest ISO-10218-1 (2011) standards for Robots and robotic devices - Safety requirements.
Meets the requirements for PL d of ISO13849-1 Category 3.

Safety circuits (emergency stop circuits) can easily be installed for the customer's entire system, not just for the robot itself. There are robots with special specifications that comply with various safety standards. Contact a Mitsubishi Electric dealer or sales agent for further details if interested.

Applicable standards

- **CE: European Conformity (European safety standards)**
 - Compliant with the EMC Directive, 2004/108/EC
 - Compliant with the Machinery Directive, 2006/42/EC
- **KCC: Korean Communications Commission (Korean safety certification)**
 - Complies with the revised Korea Radio Act (Article 58 Section 2)

Expanded J4 axis operating range

- Expanding the J4 axis operating range enables the posture to be changed continuously during assembly and transport operations. It also eliminates the need for the robot to move in the opposite direction partway through an operation.

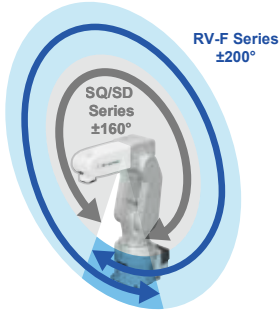

Compact installation with operation performed near the robot base

- Use of a flap-style arm contributes to a slimming of customer equipment, enabling operations to be completed in even closer proximity to the robot.

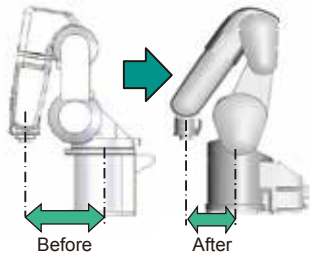

Changes in operating posture can be made even more quickly!!

- Changes in operating posture, which occur frequently during assembly, can be completed at rapid speed, increasing the speed of the axis close at hand as well as that of the base axis. Enables changes to be made to the operating posture at high speed.

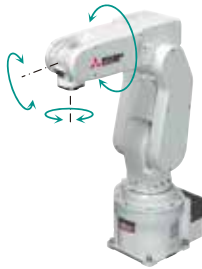

Enhanced wrist axis

- Tolerable J4 axis inertia dramatically increased. Applies easily to multiple hands, offset hands, etc. [5 times that of previous models (RH-20FH)]

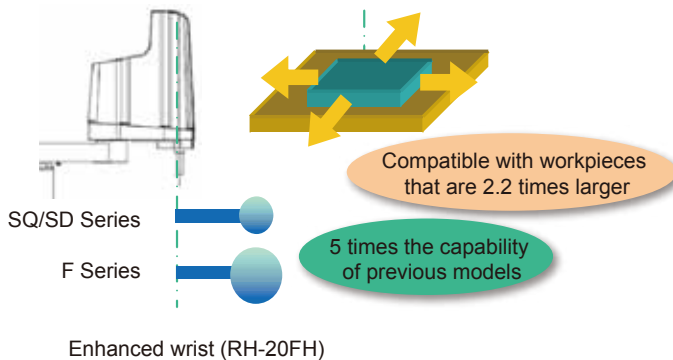

Functions

Features of IQ Platform Controllers



Improved responsiveness through high-speed communications

Increases the speed of data communications between CPUs and dramatically reduces I/O processing times using a high-speed standard base between multiple CPUs.

High-speed communications



Measurement example: Transfer of 16-word data (With data matching check)
 CC-Link: 262ms
 Between multiple CPUs: 63 ms (Approx. 4×)

Large amounts of data

The number of device points between the programmable controller and robot was increased to 8192 input points and 8192 output points. This allows the system to handle larger programs, more complicated control, and other objects that require a lot of I/O points.

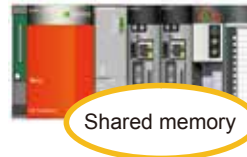

Number of I/O points: 8192/8192
Remote I/O: 256/256
CC-Link (4 stations, 1×): 126/126
CC-Link (4 stations, 8×): 894/894

4

Functions

Reduced wiring and number of units used

System costs can be reduced with the use of wireless systems and deletion of I/O units and network units.

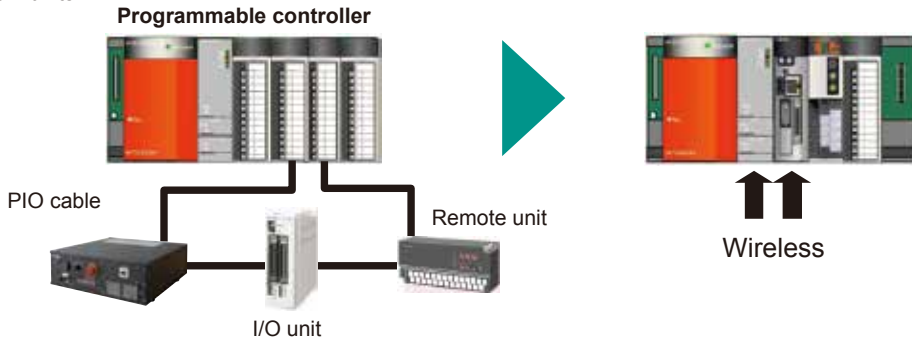

Direct communication between CPU units

Enables shared memory to be read from and written to between multiple robot CPUs. Speeds for data communications between robots increase, enabling more detailed control, such as with an interference prevention function or coordinated control, and cutting down on wasted time.



Direct communication between CPUs

No need for special programmable controller programs as shared memory is used.

Direct control between I/O units

Enables data to be read and written directly between the CPU unit and I/O unit. Responsivity improved and interlock times and cycle times shortened using high-speed I/O communications to peripheral devices.



Direct control between CPUs and I/O units

No need for programmable controller programs for signal input/output. Improved responsiveness without any delay due to scanning time.

Batch management of multiple robots

Enables access to robots in the programmable controller network from a PC connected to the main CPU. Leads to a shortening of rise times and improved maintainability for robots on the production line.

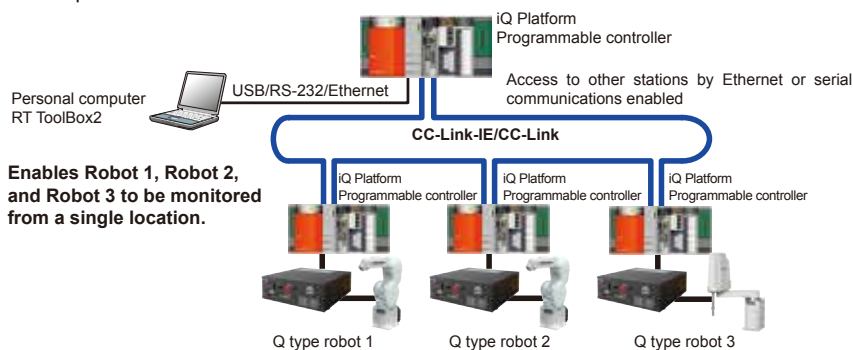

Enables Robot 1, Robot 2, and Robot 3 to be monitored from a single location.

Shared memory expansion

Enhanced efficiency of monitoring and maintenance operations onsite using a single GOT (display device) as the Human Machine Interface (HMI).

Enables the robot to be controlled from the GOT even without a teaching box.

Current robot position data, error information, and other items can be displayed easily on the GOT.

Internal robot information

- Error, variable, and program information
- Robot status (Current speed, current position, etc.)
- Maintenance information (Remaining battery capacity, grease life, etc.)
- Servo data (Load factor, current values, etc.)

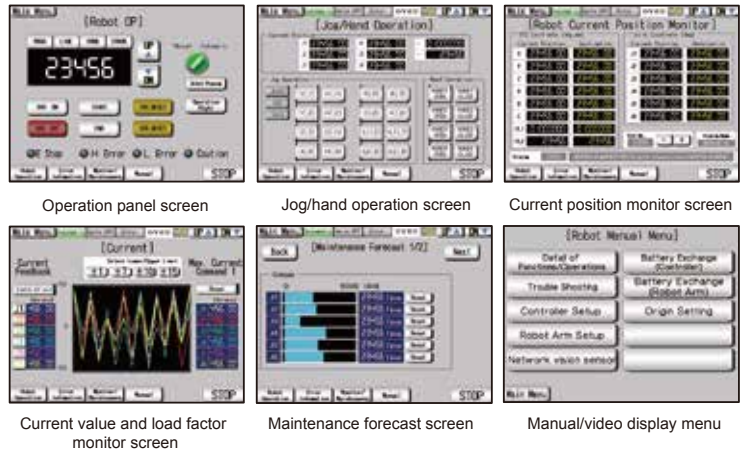

GOT connection (transparent function) (For GOT1000 Series)

Programs and parameters can be edited from the USB interface on the front of the GOT using a transparent function for improved operability.

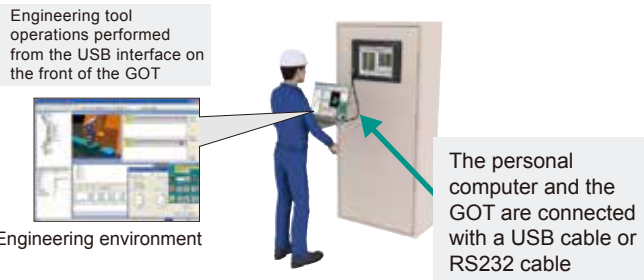

GOT backup/restore functions (Supported on GT14, GT15 and GT16)

Robot data on the GOT can be backed up to and restored from a CF card or USB memory stick. With no need for a PC.

This helps prevent data from being lost due to the empty battery / battery or robot malfunction.

Data can be saved after periodic maintenance tasks are performed or when unexpected errors occur. Dramatically improves serviceability.

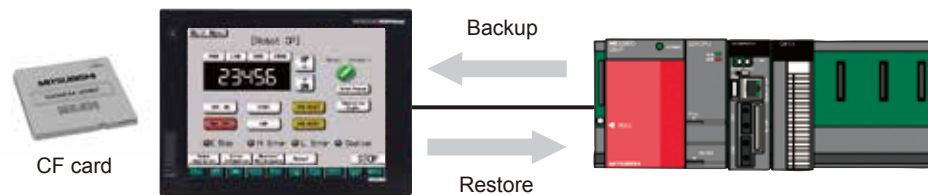

Direct execution function for programmable controllers

Robots can be controlled easily using programmable controller language. System operation can be controlled using a single programmable controller. This enables the operation of the programmable controller to handle making changes to system specifications and troubleshooting directly.

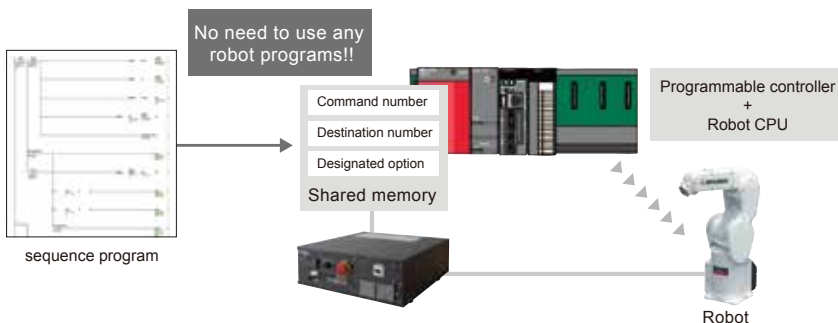

[Details of supported control operations]

Details	
Operation	<ul style="list-style-type: none"> • Joint-interpolated motion • Linear-interpolated motion
Motion control	<ul style="list-style-type: none"> • Designated override • Designated acceleration/ deceleration settings • Designated speed • Tool settings • Designated auxiliary motion • Opening/closing of hand

Functions

4

Functions

Collision Avoidance

iQ Platform

For automatic prevention of collisions between robots

The software constantly monitors robots motion, predicts collisions before they occur, and immediately stops the robots. This avoids damage to the robot during both the JOG operations and automatic mode operations. Also, this enables the number of interlocks needed to prevent collisions between robots to be reduced. (Alarm shutdown)



[Q type controllers only]

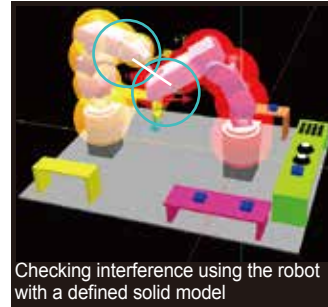

Checking interference using the robot with a defined solid model

Decreases downtime during startup operation

Reduces the number of recovery man-hours required after collisions due to teaching operation errors or failure to set interlocks

Coordinated control

iQ Platform

Coordinated control between multiple robots

Enables coordinated control between multiple robots through CPU connection between the robots. Easy to operate and use under normal operation through individual robot operation.

[Q type controllers only]



Coordinated transport

Enables transport of lengthy or heavy objects using multiple small-sized robots instead of larger ones.

Enables installation work to be completed while gripper positions between robots are maintained.

System Configuration

FQseries

System Configuration iQ Platform

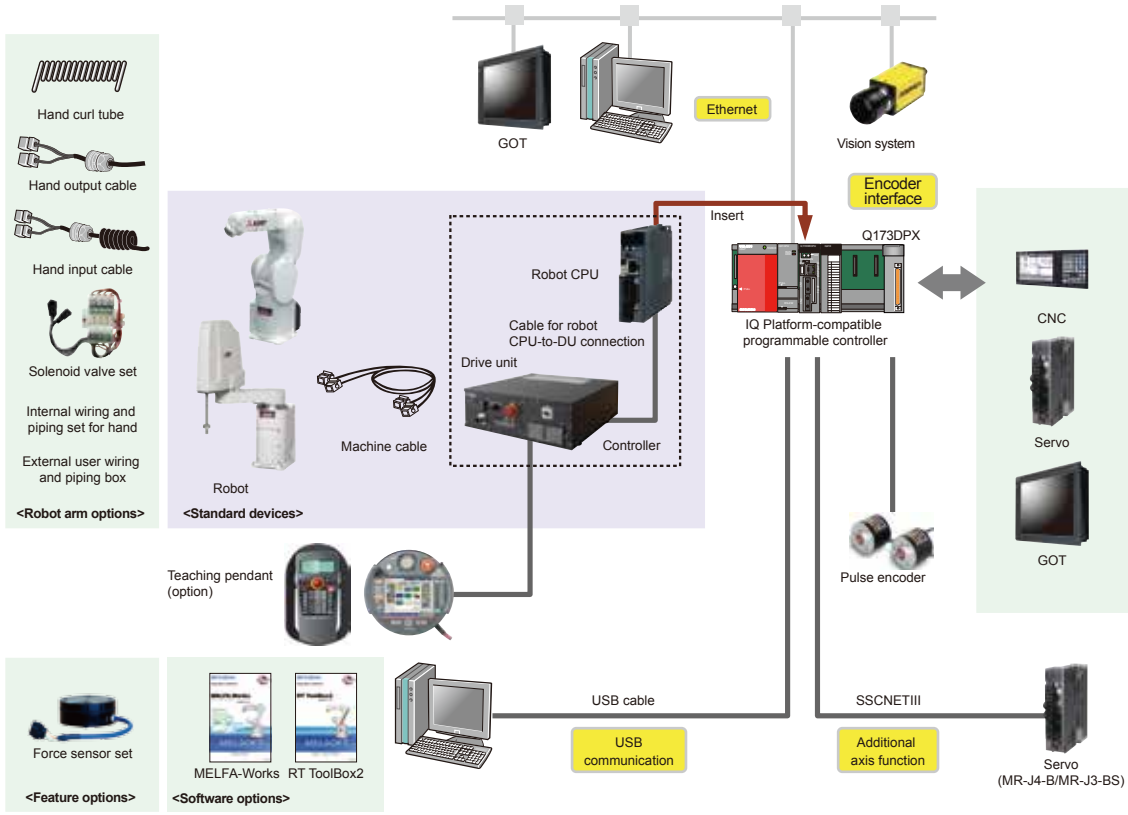

FDseries

System Configuration

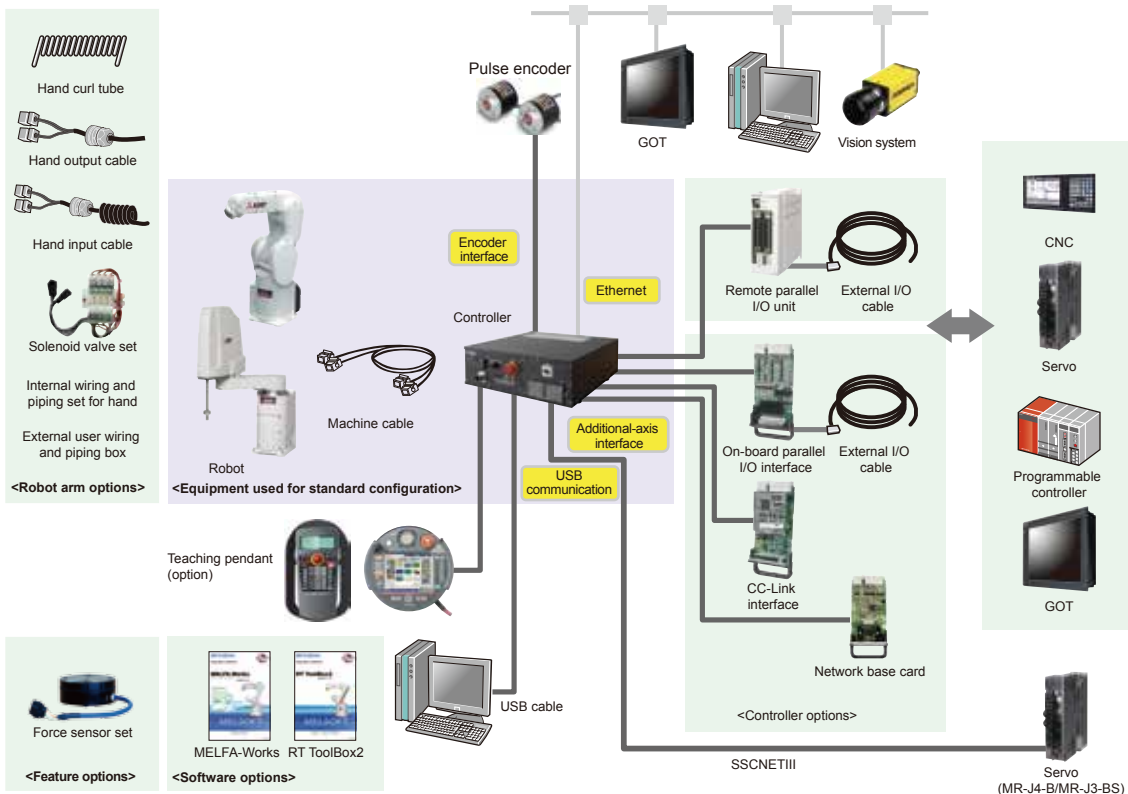

Configurations Options

Configurations options

For details, refer to the specifications sheets.

Classification	Name	Type	RV					RH				Functional specifications		
			2F 2FL	4F 4FL	7F 7FL	7FLL	13F 13FL 20F	3FH	6FH	12FH 20FH	3FHR			
Robot arm	Solenoid valve set	1E-VD0□ (Sink) 1E-VD0□E (Source)	○	-	-	-	-	-	-	-	-	-	1 to 2 valves, with solenoid valve output cable. □ indicates the number of solenoid valves (1 or 2 valves) Output: φ4	
		1F-VD0□-02 (Sink) 1F-VD0□E-02 (Source)	-	○	○	○	-	-	-	-	-	-	1 to 4 valves, with solenoid valve output cable. □ indicates the number of solenoid valves (1, 2, 3, or 4 valves) Output: φ4	
		1F-VD0□-03 (Sink) 1F-VD0□E-03 (Source)	-	-	-	-	○	-	-	-	-	-	1 to 4 valves, with solenoid valve output cable. □ indicates the number of solenoid valves (1, 2, 3, or 4 valves) Output: φ6	
		1F-VD0□-01 (Sink) 1F-VD0□E-01 (Source)	-	-	-	-	-	○	○	-	-	-	1 to 4 valves, with solenoid valve output cable. □ indicates the number of solenoid valves (1, 2, 3, or 4 valves) Output: φ4	
		1S-VD0□-01 (Sink) 1S-VD0□E-01 (Source)	-	-	-	-	-	-	-	○	-	-	1 to 4 valves, with solenoid valve output cable. □ indicates the number of solenoid valves (1, 2, 3, or 4 valves) Output: φ6	
		1S-VD04-05 (Sink) 1S-VD04E-05 (Source)	-	-	-	-	-	-	-	-	○	-	-	4 valves, with solenoid valve output cable. Output: φ4 (Standard)
		1S-VD04W-05 (Sink) 1S-VD04WE-05 (Source)	-	-	-	-	-	-	-	-	-	○	-	4 valves, with solenoid valve output cable. Output: φ4 (water proof/clean)
		Hand output cable	1E-GR35S	○	-	-	-	-	-	-	-	-	-	Straight cable for 2-solenoid valve systems, total length of 300 mm, with a robot connector on one side and unterminated on the other side
			1F-GR35S-02	-	○	○	○	○	-	-	-	-	-	Straight cable for 4-solenoid valve systems, total length of 300 mm, with a robot connector on one side and unterminated on the other side
	1F-GR60S-01		-	-	-	-	-	○	○	○	-	-	Straight cable for 4-solenoid valve systems, total length of 1050 mm, with a robot connector on one side and unterminated on the other side, equipped with a splash-proof grommet	
	1S-GR35S-02		-	-	-	-	-	-	-	-	○	-	Straight cable for 4-solenoid valve systems, total length of 450 mm, with a robot connector on one side and unterminated on the other side	
	Hand input cable	1S-HC30C-11	○	-	-	-	-	-	-	-	-	-	4-point type, with a robot connector on one side and unterminated on the other side	
		1F-HC35S-02	-	○	○	○	○	-	-	-	-	-	8-point type, total length of 1000 mm, with a robot connector on one side and unterminated on the other side	
		1F-HC35C-01	-	-	-	-	-	○	○	-	-	-	8-point type, total length of 1650 mm (includes a 350-mm-long curled section), with a robot connector on one side and unterminated on the other side, equipped with a splash-proof grommet	
		1F-HC35C-02	-	-	-	-	-	-	-	-	○	-	8-point type, total length of 1800 mm (includes a 350-mm-long curled section), with a robot connector on one side and unterminated on the other side, equipped with a splash-proof grommet	
	Hand (curl) tube	1S-HC00S-01	-	-	-	-	-	-	-	-	-	○	4-point type, total length of 1210 mm, with a robot connector on one side and unterminated on the other side	
		1E-ST040□C	○	○	○	○	-	-	-	-	-	-	For 1- to 4-φ4-valve systems, total length of 630 mm (including the curl part 180 mm). □ indicates the number of solenoid valves (2, 4, 6, or 8 valves). For RV-2F series, 2 or 4 valves only	
		1E-ST0408C-300	-	-	-	-	-	○	○	-	-	-	For 4-φ4-valve systems, total length of 1000 mm (including curl part)	
		1N-ST060□C-01	-	-	-	-	○	-	-	-	-	-	For 1- to 4-φ6-valve systems, total length of 1150 mm (including the curl part 250 mm). □ indicates the number of solenoid valves (2, 4, 6, or 8 valves).	
	Hand tube	1N-ST0608C-01	-	-	-	-	-	-	-	-	○	-	For 1- to 4-φ6-valve systems, total length of 1300 mm (including curl part 250 mm)	
		1S-ST0304S	-	-	-	-	-	-	-	-	-	○	φ3: 2 valves (Maximum usable length: 400mm)	
	External wiring set 1 for the forearm	1F-HB01S-01	-	○	○	○	○	-	-	-	-	-	Used for the forearm. External wiring box used for connecting the hand input cable, the Ethernet cable, and the electrical hand and force sensor cable.	
	External wiring set 2 for the forearm	1F-HB02S-01	-	○	○	○	○	-	-	-	-	-	Used for the forearm. External wiring box used for connecting the force sensor, the electrical hand, and the Ethernet cable.	
	External wiring set 1 for the base	1F-HA01S-01	-	○	○	○	○	-	-	-	-	-	Used for the base. External wiring box used for connecting the communications output for the electrical hand, the electrical hand and force sensor cable, and the Ethernet cable. There are hand input connection available.	
	External wiring set 2 for the base	1F-HA02S-01	-	○	○	○	○	-	-	-	-	-	Used for the base. External wiring box used for connecting the communications output for the electrical hand, the electrical hand, the force sensor cable, and the Ethernet cable. No hand input connection available.	
	Internal wiring and piping set for hand	1F-HS604S-01	-	-	-	-	-	-	-	-	○	-	Wiring and piping set for internal mounting in the tip axis (Compatible with 8 input points for hand systems + φ6-2 solenoid valve systems) For 350mm Z-axis stroke	
1F-HS604S-02		-	-	-	-	-	-	-	-	○	-	Wiring and piping set for internal mounting in the tip axis (Compatible with 8 input points for hand systems + φ6-2 solenoid valve systems) For 450mm Z-axis stroke		
1F-HS408S-01		-	-	-	-	-	-	-	-	○	-	Wiring and piping set for internal mounting in the tip axis (Compatible with 8 input points for hand systems + φ4-4 solenoid valve systems) For 200mm Z-axis stroke		
1F-HS408S-02		-	-	-	-	-	-	-	-	○	-	Wiring and piping set for internal mounting in the tip axis (Compatible with 8 input points for hand systems + φ4-4 solenoid valve systems) For 340mm Z-axis stroke		
1F-HS304S-01		-	-	-	-	-	-	-	○	-	-	Wiring and piping set for internal mounting in the tip axis (Compatible with 4 input points for hand systems + φ3-2solenoid valve systems)		
External user wiring and piping box	1F-UT-BOX	-	-	-	-	-	-	○	○	-	-	Box for external wiring of user wiring (hand I/O, hand tube)		
Machine cable (replacement for shorter 2m type) (*1)	1F-UT-BOX-01	-	-	-	-	-	-	-	-	○	-	Box for external wiring of user wiring (hand I/O, hand tube)		
	1S-Q2UCBL-01	-	○	○	○	○	-	-	○	○	○	2m long cables for securement purposes (2-wire set with power supply and signal)		
Machine cable, for extension/fix CR-750	1F-Q2UCBL-01	-	-	-	-	-	-	○	-	-	-	2m long cables for securement purposes (2-wire set with power supply and signal)		
	1S-□□CBL-11	○	-	-	-	-	-	-	-	-	-	Exchange type, extended length 5m, 10m, 15m (2wires set with power and signal wires) □ indicates the length of cables (5, 10, 15m)		
	1S-□□CBL-01	-	○	○	○	○	-	○	○	○	○	Extension type, extended length 5m, 10m, 15m (2wires set with power and signal wires) □ indicates the length of cables (5, 10, 15m)		
Machine cable, for extension/fix CR-751	1S-□□CBL-03	-	-	-	-	-	-	○	-	-	-	Extension type, extended length 5m, 10m, 15m (2wires set with power and signal wires) □ indicates the length of cables (5, 10, 15m)		
	1F-□□UCBL-11	○	-	-	-	-	-	-	-	-	-	Exchange type, extended length 5m, 10m, 15m (2wires set with power and signal wires) □ indicates the length of cables (5, 10, 15m)		
	1F-□□UCBL-02	-	○	○	○	○	○	○	○	○	○	Exchange type, extended length 10m, 15m, 20m (2wires set with power and signal wires) □ indicates the length of cables (10, 15, 20m)		
Machine cable, for extension/flexible CR-750	1S-□□LCBL-11	○	-	-	-	-	-	-	-	-	-	Exchange type, extended length 5m, 10m, 15m (2wires set with power and signal wires) □ indicates the length of cables (5, 10, 15m)		
	1S-□□LCBL-01	-	○	○	○	○	-	○	○	○	○	Extension type, extended length 5m, 10m, 15m (2wires set with power and signal wires) □ indicates the length of cables (5, 10, 15m)		
	1S-□□LCBL-03	-	-	-	-	-	-	○	-	-	-	Extension type, extended length 5m, 10m, 15m (2wires set with power and signal wires) □ indicates the length of cables (5, 10, 15m)		
Machine cable, for extension/flexible CR-751	1F-□□LUCBL-11	○	-	-	-	-	-	-	-	-	-	Exchange type, extended length 5m, 10m, 15m (2wires set with power and signal wires) □ indicates the length of cables (5, 10, 15m)		
	1F-□□LUCBL-02	-	○	○	○	○	○	○	○	○	○	Exchange type, extended length 10m, 15m, 20m (2wires set with power and signal wires) □ indicates the length of cables (10, 15, 20m)		
	1S-DH-11J1	○	-	-	-	-	-	-	-	-	-	Stopper for making changes, installed by customer		
Stopper for changing the J1-axis operating range	1F-DH-05J1	-	-	-	○	○	-	-	-	-	-	Stopper for making changes, installed by customer (Compatible with the RV-7FLL.)		
	1F-DH-04	-	-	○	-	-	-	-	-	-	-	Stopper for making changes, installed by customer		
	1F-DH-03	-	○	-	-	-	-	-	-	-	-	Stopper for making changes, installed by customer		
	1F-DH-02	-	-	-	-	-	-	-	-	○	-	Stopper for making changes, installed by customer		
	1S-DH-01	-	-	-	-	-	-	○	○	-	-	Stopper for making changes, installed by customer		
	1S-DH-05J1	-	-	-	-	-	-	-	-	-	○	Stopper for making changes, installed by customer		
	Stopper for changing the J2-axis operating range	1S-DH-11J2	○	-	-	-	-	-	-	-	-	-	Stopper for making changes, installed by customer	
1S-DH-05J2		-	-	-	-	-	-	-	-	-	○	Stopper for making changes, installed by customer		
Stopper for changing the J3-axis operating range	1S-DH-11J3	○	-	-	-	-	-	-	-	-	-	Stopper for making changes, installed by customer		

Note 1) This is a special specification for shipping. Inquire for delivery and prices.

Classification	Name	Type	CR750		CR751		CR760		Functional specifications
			Q type	D type	Q type	D type	Q type	D type	
Controller	Standard teaching pendant (7m, 15m)	R32TB(-**)	○	○	-	-	○	○	7 m: Standard, 15 m: Custom ("-15" is included in the model name) For controller CR-750-*
	High-function teaching pendant (7 m, 15 m)	R56TB(-**)	○	○	-	-	○	○	7 m: Standard, 15 m: Custom ("-15" is included in the model name) For controller CR-750-*
	Standard teaching pendant (7m, 15m)	R33TB(-**)	-	-	○	○	-	-	7 m: Standard, 15 m: Custom ("-15" is included in the model name) For controller CR-751-*
	High-function teaching pendant (7 m, 15 m)	R57TB(-**)	-	-	○	○	-	-	7 m: Standard, 15 m: Custom ("-15" is included in the model name) For controller CR-751-*
	Conversion cable for the teaching box	2F32CON03M	-	-	○	○	-	-	Conversion cable used to connect the R32TB to the CR-751 controller. Cable length: 3 m.
	On-board Parallel I/O interface (Sink type) (Source type)	2A-RZ361 2A-RZ371	-	○	-	○	-	○	32 output points/ 32 input points
	Remote Parallel I/O cable (5m, 15m)	2A-CBL**	-	○	-	○	-	○	CBL05: 5 m, CBL15: 15 m, not terminated at one end. For 2A-RZ361/371.
	On-board Parallel I/O interface (Installed internally) (Sink type) (Source type)	2D-TZ368 2D-TZ378	-	○	-	○	-	○	32 output points/ 32 input points
	Remote Parallel I/O cable (5m, 15m)	2D-CBL**	-	○	-	○	-	○	CBL05: 5 m, CBL15: 15 m, not terminated at one end. For 2D-TZ368/378.
	CC-Link interface	2D-TZ576	-	○	-	○	-	○	CC-Link Intelligent device station, Ver. 2.0, 1 to 4 stations
	Network base card	2D-TZ535	-	○	-	○	-	-	Communication interface for installing an HMS Anybus-CompactCom module An HMS EtherNet/IP module (AB6314) and a PROFINET IO module (AB6489-B) must be separately prepared by customers.
	Force sensor set	4F-FS001-W200	○	○	○	○	-	-	Set of devices required for the force control function including a force sensor and interface unit
	MELFA- 3D Vision	4F-3DVS2-PKG1	○	○	○	○	-	-	Set of devices required for the 3D vision sensor function, including a 3D camera head and control unit (applicable model: RV-F series)
	Terminal block replacement tool for the user wiring	2F-CNUSR01M	-	-	○	○	-	-	Terminal block replacement tool for the wiring for the external input/output, such as emergency input/output, door switch input, and enabling device input
	Encoder distribution unit	2F-YZ581	○	○	○	○	-	-	Unit for connecting one rotary encoder to multiple robot controllers (up to four controllers) when the tracking function is used
	Controller protection box	CR750-MB	○	○	-	-	-	-	With a built-in CR750-D/Q for improved dust-proofing to IP54 (dedicated CR750)
		CR751-MB	-	-	○	○	-	-	With a built-in CR751-D/Q for improved dust-proofing to IP54 (dedicated CR751)
	Personal computer support software	3D-11C-WINJ	○	○	○	○	○	○	With simulation function (CD-ROM) (RT ToolBox2)
Personal computer support software -mini	3D-12C-WINJ	○	○	○	○	○	○	Simple version (CD-ROM)(RT ToolBox2 mini)	
Simulator (MELFA-Works)	3F-21D-WIN	○	○	○	○	○	○	Layout study/Takt time study/Program debug. Add-in software for Solidworks® (64 bit compatible, DVD)	
Extension memory	2D-TZ454	-	-	-	-	-	○	Extended user program area of 2 MB	

Configurations options (-SE01)**

The following options are dedicated for the environmentally-resistant models (Chemical-resistant specification: -SE**01). For other models, refer to the options for the standard models.

Classification	Name	Type	RV				RH		Functional specifications
			4F 4FL	7F 7FL	7FLL	13F 13FL 20F	6FH	12FH 20FH	
			SE**01	SE**01	SE**01	SE**01	SE**01	SE**01	
Robot arm	Solenoid valve set	1F-VD0□-04(Sink) 1F-VD0□E-04 (Source)	○	○	○	-	-	-	1 to 4 valves, with solenoid valve output cable. □ indicates the number of solenoid valves (1, 2, 3, or 4 valves) Output: φ4
		1F-VD0□-05 (Sink) 1F-VD0□E-05 (Source)	-	-	-	○	-	-	1 to 4 valves, with solenoid valve output cable. □ indicates the number of solenoid valves (1, 2, 3, or 4 valves) Output: φ6
		1F-HB01S-02	○	○	○	○	-	-	Used for the forearm. External wiring box used for connecting the hand input cable, the Ethernet cable, and the electrical hand and force sensor cable.
	External wiring set 2 for the forearm	1F-HB02S-02	○	○	○	○	-	-	Used for the forearm. External wiring box used for connecting the force sensor, the electrical hand, and the Ethernet cable.
	External wiring set 1 for the base	1F-HA01S-02	○	○	○	○	-	-	Used for the base. External wiring box used for connecting the communications output for the electrical hand, the electrical hand and force sensor cable, and the Ethernet cable. There are hand input connection available.
	External wiring set 2 for the base	1F-HA02S-02	○	○	○	○	-	-	Used for the base. External wiring box used for connecting the communications output for the electrical hand, the electrical hand, the force sensor cable, and the Ethernet cable. No hand input connection available.
	External user wiring and piping box	1F-UT-BOX-04	-	-	-	-	○	-	Box for external wiring of user wiring (hand I/O, hand tube)
		1F-UT-BOX-03	-	-	-	-	-	○	Box for external wiring of user wiring (hand I/O, hand tube)
	Machine cable, for extension/fixed CR-751	1F-□□UCBL-03	○	○	○	○	○	○	Exchange type, extended length 10m, 15m, 20m (2wires set with power and signal wires) □□ indicates the length of cables (10, 15, 20m)
	Machine cable, for extension/flexible CR-751	1F-□□LUCBL-03	○	○	○	○	○	○	Exchange type, extended length 10m, 15m, 20m (2wires set with power and signal wires) □□ indicates the length of cables (10, 15, 20m)
	Stopper for changing the J1-axis operating range	1F-DH-06	○	-	-	-	-	-	Stopper for making changes, installed by customer
		1F-DH-07	-	○	-	-	-	-	Stopper for making changes, installed by customer
1F-DH-08		-	-	○	○	-	-	Stopper for making changes, installed by customer	
1F-DH-09		-	-	-	-	○	-	Stopper for making changes, installed by customer	
1F-DH-10		-	-	-	-	-	○	Stopper for making changes, installed by customer	

Options

RV-4F/RV-7F/13F/20F Series Tooling device configuration

Hand configuration	Wiring format	Robot specifications	Required device		Comments
			External wiring set for the forearm	External wiring set for the base (*3)	
• Air-hand + Hand input signal	Interior equipment	-SH01	— (*1)	—	Air hoses: Up to 2 systems (4 mm diameter x 4); 8 input signals
	Exterior equipment	Standard	— (*2)	—	Air hoses: Up to 4 systems (4 mm diameter x 8) are possible.
• Air-hand + Hand input signal • Vision sensor	Interior equipment	-SH05	— (*1)	(1F-HA01S-01)	Air hoses: Up to 1 systems (4 mm diameter x 2); 8 input signals
	Exterior equipment	Standard	1F-HB01S-01 (*2)	1F-HA01S-01	Air hoses: Up to 4 systems (4 mm diameter x 8) are possible.
• Air-hand + Hand input signal • Force sensor	Interior equipment	-SH04	— (*1)	(1F-HA01S-01)	Air hoses: Up to 1 systems (4 mm diameter x 2); 8 input signals
	Exterior equipment	Standard	1F-HB01S-01 (*2)	1F-HA01S-01	Air hoses: Up to 4 systems (4 mm diameter x 8) are possible.
• Air-hand + Hand input signal • Vision sensor • Force sensor	Interior equipment (Air hoses are part of exterior equipment)	-SH02	— (*1)	(1F-HA01S-01)	Air hoses are exterior equipment: 4 systems (4 mm diameter x 8)
	End the connection	Standard	1F-HB01S-01	1F-HA01S-01	Air hoses: Up to 4 systems (4 mm diameter x 8) are possible.

*1: Users must provide the solenoid valves for Internal wiring model air-hands.
 *2: Users must provide solenoid valves and hoses/input cables as needed for External wiring model air-hands.
 *3: The external wiring set for the base is provided for models with Internal wiring and hoses.

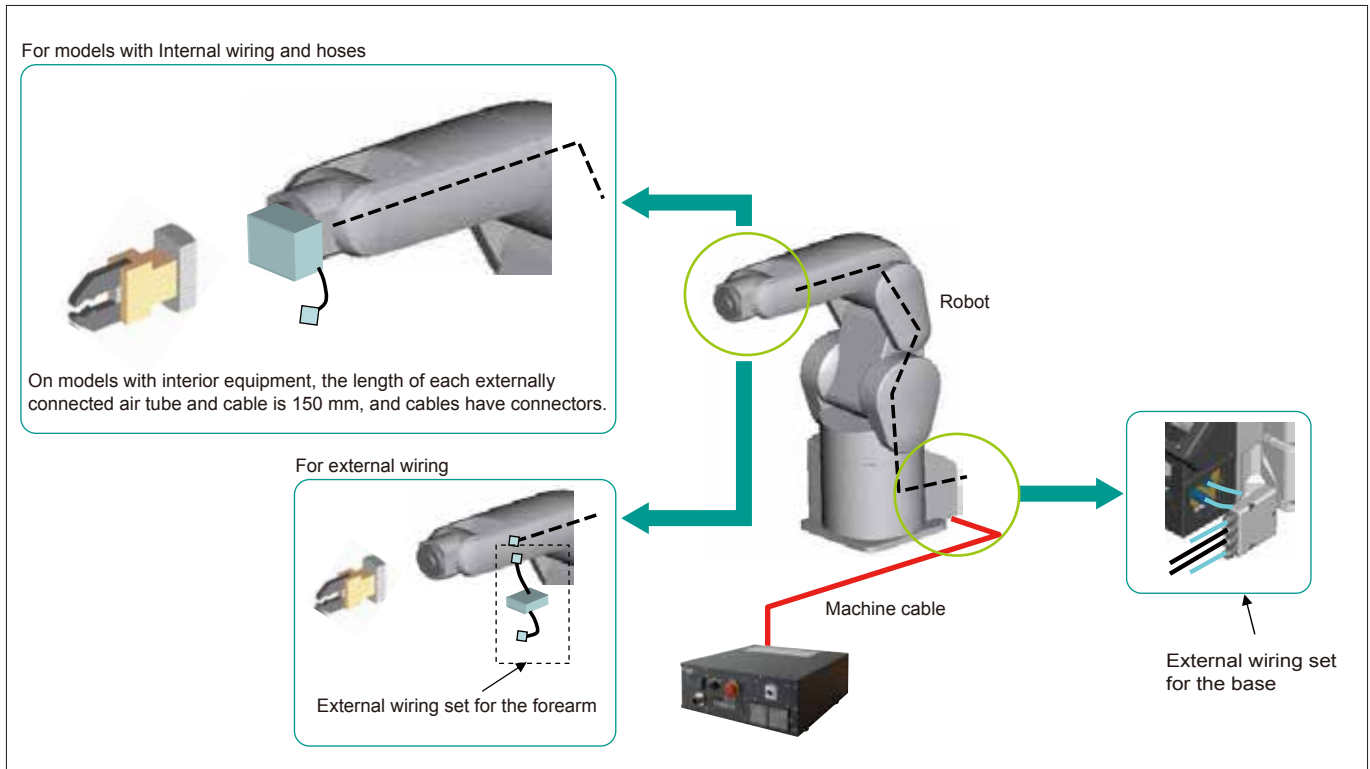

► Models with Internal wiring and hoses

Devices supporting interior hoses	Model (special device number)			
	-SH01	-SH02	-SH04	-SH05
Air 4 mm diameter (x4/x2)	○ (x4)	—	○ (x2)	○ (x2)
Hand inputs (x8)	○	○	○	○
Ethernet (Vision sensor)	—	○	—	○
Force sensor	—	○	○	—

► Safety Option

Type	Applicable robot controller
4F-SF001-01	CR750-D/Q
	CR751-D/Q

RV series Tooling (air-hand) : External wiring

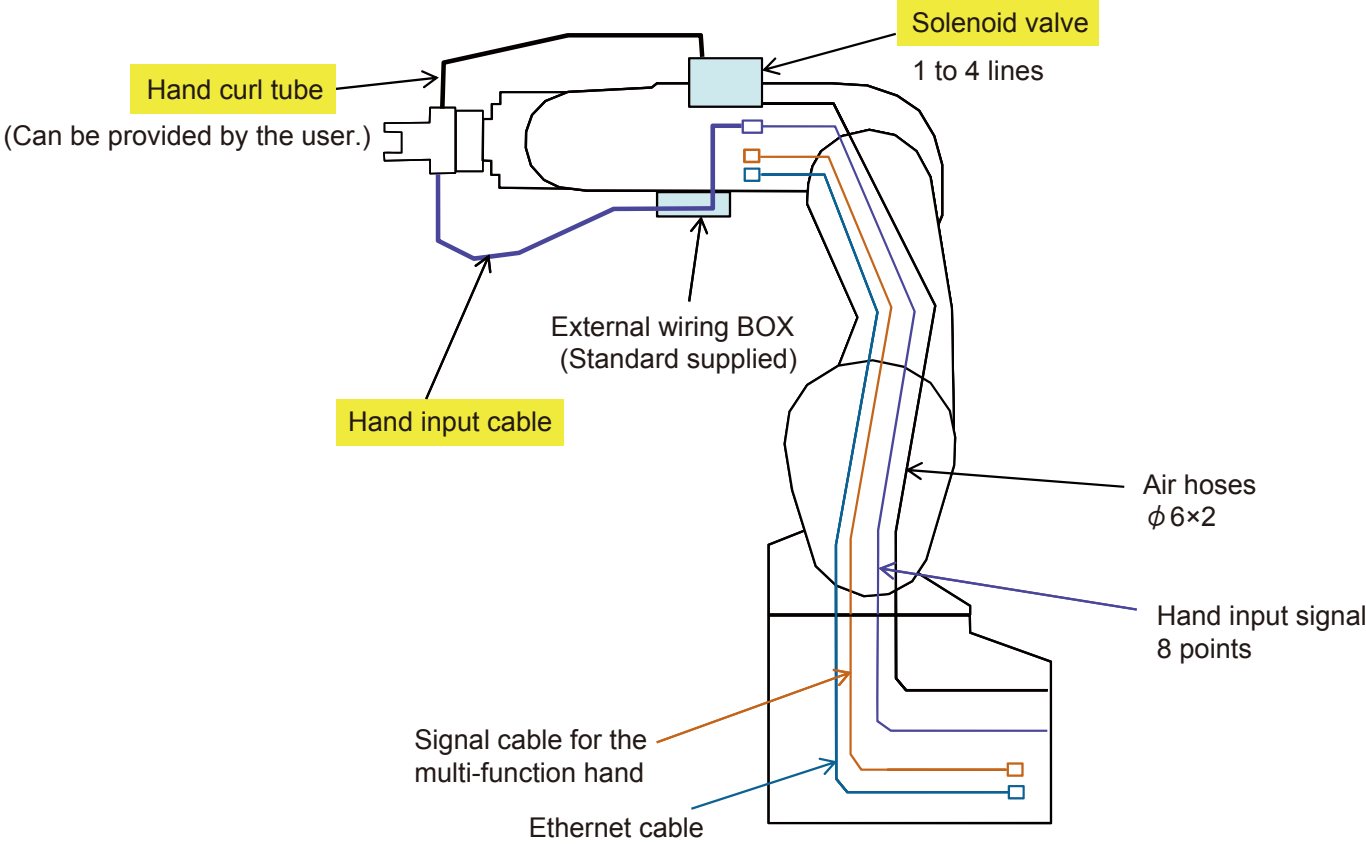

RV series Tooling (air-hand) : Internal wiring

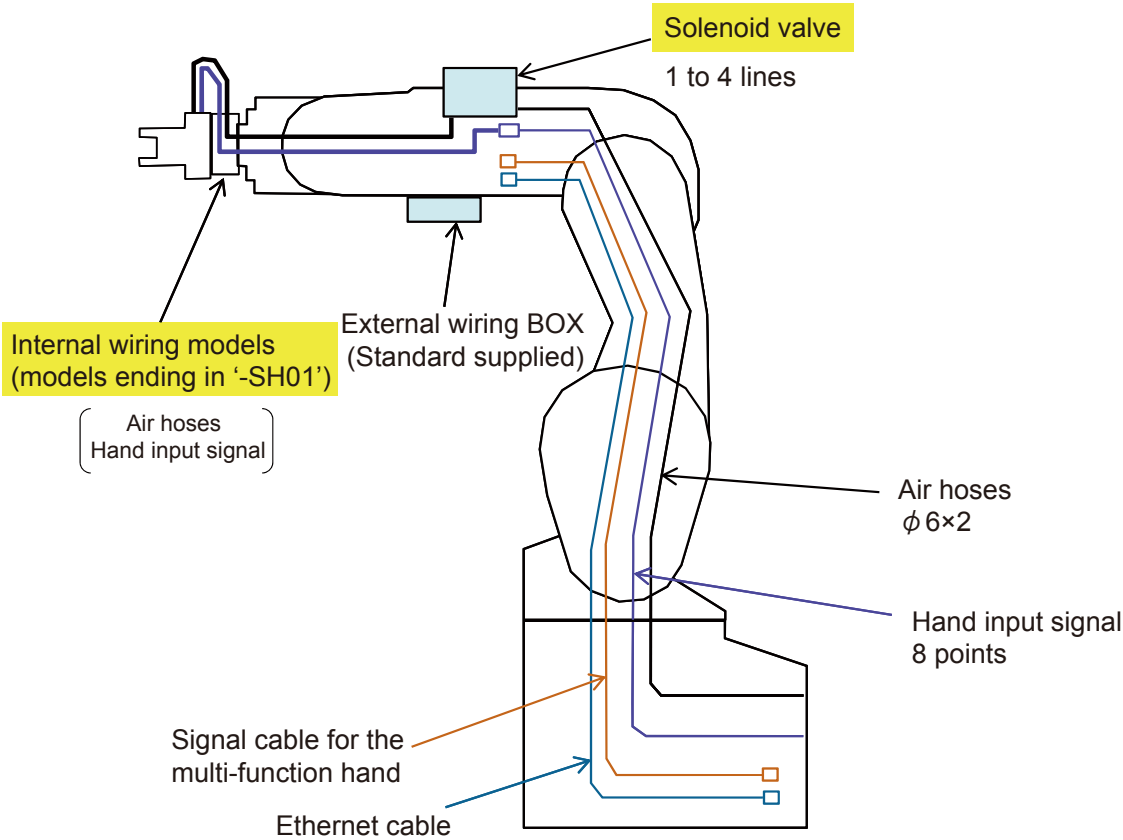

Options

RT ToolBox2

Type: 3D-11C-WINE

Software for program creation and total engineering support.

This PC software supports everything from system startup to debugging, simulation, maintenance and operation. This includes programming and editing, operational checking before robots are installed, measuring process tact time, debugging during robot startup, monitoring robot operation after startup, and trouble shooting.

Windows®-compatible

- Easy operation on Windows®.
- Compatible with Windows® 2000, Windows® XP, Windows® Vista, and Windows® 7 (32-bit Ver. 1.8 or later, 64-bit Ver. 2.0 or later).

*Windows is registered trademarks of Microsoft Corporation in the United States and other countries.

Enhanced simulation functions

- This function is compatible with all models that connect to CRn-500 series and CRn-700 controllers.
- Robots can be operated and tact time calculated using a personal computer. (Not available for the mini version.)
- Robot movements, operating status, input signals, and servo status can be monitored.

Support for all processes, from programming and startup to maintenance

- Programming can be completed using the MELFA-BASIC IV/V and Movemaster languages (vary depending on the model).
- Robot movement and operating status, input signals, and servo status can be monitored.

Advanced maintenance functions

- The software has a maintenance function that notifies the operators greasing periods, battery life cycles as well as position recovery support function when trouble occurs, etc. and is effective for preventative maintenance, shortening of recovery time.

7

Options

■ Program editing and debugging functions

Creation of programs in MELFA-BASIC IV/V and the Movemaster languages. *1 Improvement of work operations by a multi-window format and the various editing functions. This is helpful for use in checking operations such as the execution of program steps, setting of breakpoint settings, and other tasks.

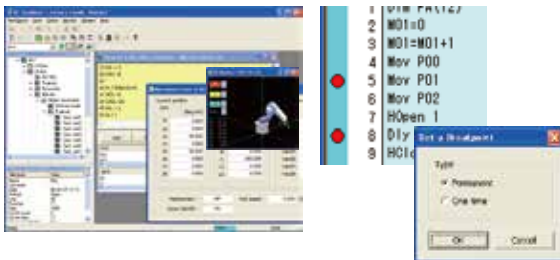

■ 3D viewer

Graphical representation of a work along with the dimensions, color and other specified details of the work area to be gripped.

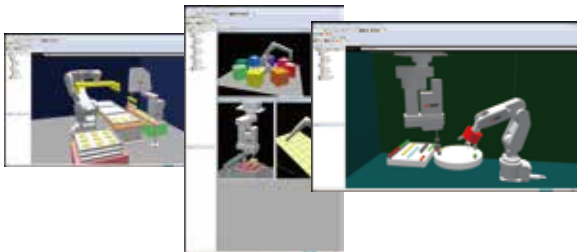

■ Simulation functions

Offline robot motion and tact time check for designated parts of a program.



■ Monitor functions

This is used to monitor program execution status and variables, input signals, etc.



■ Maintenance functions

These functions include maintenance forecast, position recovery support, parameter management, etc.

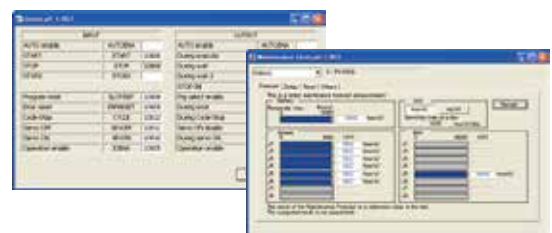

*1: MELFA-BASIC is a programming language that further expands upon and develops the commands needed for robot control. In MELFA-BASIC IV/V, the expansion of the command as well as parallel processing or structuring that were difficult to realize in BASIC language can make it possible to operate MELFA easily.

<Example of a Pick & Place program>

Mov Psafe	Move the evasion point
Mov Pget.-50	'Move the workpiece extraction position up
Mvs Pget	'Move the workpiece extraction position
Dly 0.2	'Wait 0.2-sec. on standby
Hclose 1	'Close the hand
Dly 0.2	'Wait 0.2-sec. on standby
Mvs Pget.-50	'Move the workpiece extraction position up
Wait M_In(12)=1	'Wait for a signal
Mov Pput.-80	'Move the workpiece position up
Mvs Pput	'Move the workpiece position
Dly 0.2	'Wait 0.2-sec. on standby
Hopen 1	'Close the hand
.....	

Classification	Main functions
Operation-related	Joint, linear, and circular interpolation, optimal acceleration/deceleration control, compliance control, collision detection, and singular point passage
Input/output	Bit/byte/word signals, interrupt control
Numerical operations	Numerical operations, pose (position), character strings, logic operations
Additional functions	Multi-tasking, tracking, and vision sensor functions

MELFA-Works

Type: 3F-21D-WINE

3D robot simulator offering powerful support for system design and preliminary layout.

What is MELFA-Works?

MELFA-Works is an add-in tool (*1) for SolidWorks(*2) used for robot simulation in production systems on PC's converting processing paths of workpieces into robot position data. Adding MELFA-Works into...on the robot simulation functions.

*1) An add-in tool is a software program that adds certain functions to application software packages.
 *2) SolidWorks® is a registered trademark of SolidWorks Corp, (USA).

Features

Automatic robot program creation function

The teaching position data and robot operation programs necessary for operating robots can be generated automatically by simple loading of 3D CAD data (*3) for the applicable works into SolidWorks® and then setting of processing conditions and areas using MELFA-Works.

*3) Formats that can be loaded into SolidWorks®

- IGES
- STEP
- ParasolidR
- SAT (ACISR)
- Pro/ENGINEER
- CGR (CATIARgraphics)
- Unigraphics
- PAR (Solid Edge TM)
- IPT (Autodesk Inventor)
- DWG
- DXFTM
- STL
- VRML
- VDA-FS
- Mechanical Desktop
- CADKEYR
- Viewpoint
- RealityWave
- HOOPS
- HCG (Highly compressed graphics)

Note) Check the SolidWorks website and other published documents for the latest specifications.

Example Screens for MELFA-Works

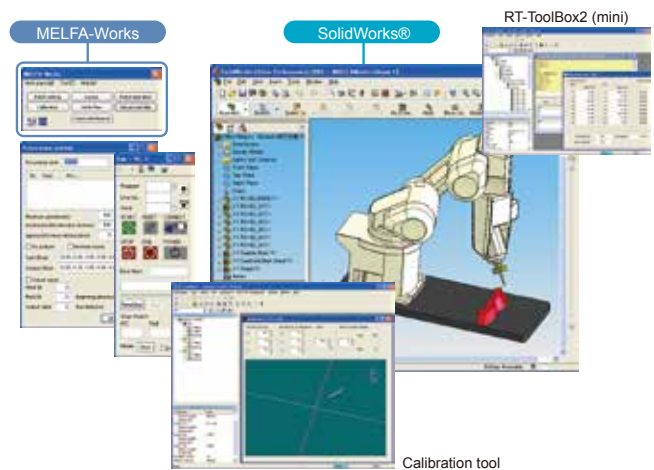

7

Options

List of functions

Loading of part data from peripheral devices and rearrangement

Part data created in Solidworks® can be loaded. The positions of loaded parts can be rearranged relative to the CAD origin and other parts. Part positions can also be changed via numerical input.

Installation of hands

Hands designed/created in SolidWorks® can be installed on robots. An ATC (Auto Tool Changer) can also be specified for each hand.

Handling of work

Simulations of hand signal control can be created using a robot program to handle workpieces.

CAD link

Operation data needed to perform sealing and other operations requiring many teaching steps are easily created. All you need is to select the target area to be processed from 3D CAD data. Since operation data is created from 3D CAD source data, complex three-dimensional curves can be recreated with ease. This leads to significant reduction in teaching time.

Offline teaching

The robot posture can be set up on the screen in advance.

Creation of robot programs (template)

Workflow processes can be created using a combination of the offline teaching and CAD link functions and then converted into robot programs. (MELFA-BASIC IV, V format)

Assignment of robot programs

Robot programs can be used as is without any modifications. A different robot program can also be specified for each task slot.

Simulation of robot operations

Robot programs, including I/O signals, can be simulated. This means that movements of the actual system can be recreated directly and accurately. The following two methods are provided to simulate I/O signals of your robot controller.

- (1) Create simple definitions of operations associated with I/O signals.
- (2) Link I/O signals with GX Simulator.

Display of the robot movement path

Robot movement path can be displayed in the application / the workspace as.

Interference checks

Interference between the robot and peripheral devices can be checked. A target of interference check can be specified by a simple mouse click it on the screen. Information explaining the condition of interference that occurred (such as the contacted part, program line that was being executed when the interference occurred, and corresponding robot position) can be saved to a logfile.

Saving of video data

Simulated movements can be saved to video files (AVI format).

Measurement of cycle times

The cycle time of robot movement can be measured using an easy-to-use function resembling a stopwatch. It realizes the cycle time measurement of a specified part in a program.

Robot program debugging functions

The following functions are provided to support the debug of robot programs.

- Step operation : A specified program can be executed step by step.
- Breakpoint : Breakpoints can be set in a specified program.
- Direct execution : Desired robot commands can be executed.

Jog function

The robot shown in SolidWorks® can be jogged just like a real robot.

Traveling axis

A traveling axis can be installed to a robot to verify the operation of the system equipped with this.

Calibration

Point sequence data of CAD coordinates created by the CAD link function can be corrected to robot coordinate data.

Operation programs and point sequence data can also be transferred to robots. To provide greater convenience for operators who perform calibration frequently on site, the calibration tool is provided as an application independent of MELFA-Works.

Accordingly, the calibration tool can be operated effectively on a notebook computer in which SolidWorks® software is not installed

Options

Force sensor set

Type: 4F-FS001-W200

Allows copy and fitting work to be completed in the same way a person would while the force applied to the hand is monitored.

Enables necessary work such as fine force adjustments and force detection to be completed.

Improved production stability

Enables parts to be inserted or attached without being damaged while absorbing shifts in position due to part variations and emulating the slight amounts of external force applied. Improved operating stability gained through position latches and retry processes when work operations fail. Log data can be used to manage quality control and analyze causes of work errors and other issues.

Allows assembly of more complicated configurations

Force detection during contact allows operating directions and applied force to be changed and interrupts to be executed under trigger conditions combining position and force information.

Simple control

Simple programs can be created using specialized robot language.

Simple operation

Work conditions can be checked and adjusted by viewing position and force data from the teaching box and graphs on RT ToolBox2.

Product features

Item	Features	
Force control	Force control	Function for controlling robots while applying a specified force
	Stiffness control	Function for controlling the stiffness of robot appendages
	Gain changes	Function for changing control characteristics while the robot is running
Force detection	Execution of interrupts	Interrupts can be executed (MO triggers) under trigger conditions combining position and force information.
	Data latch	Function for acquiring force sensor and robot positions while contact made
	Data reference	Function for display force sensor data and maintaining maximum values
Force log	Synchronous data	Function for acquiring force sensor information synchronized to position information as log data and displaying it in graph form
	Start/stop trigger	Allows logging start/stop commands to be specified in robot programs
	FTP transmission	Function for transferring acquired log files to the FTP server
Teaching box	Force sense control	Enables/disables force sensor control and sets control conditions while jogging.
	Force sense monitor	Displays sensor data and the force sense control setting status.
	Teaching position search	Function for searching for the contact position.
	Parameter setting screen	Parameter setting screen dedicated for the force sense function. (For R565B/R57TB)

Product Configuration

Name	Qty.
Force sensor	Qty. 1
Force sensor interface unit	Qty. 1
Sensor adapter	Qty. 1
Adapter cable	Qty. 1
24V DC power supply	Qty. 1
24V DC power supply cable	1m
Serial cable between the unit and sensor	5m
SSCNET III cable	10m

System Configuration

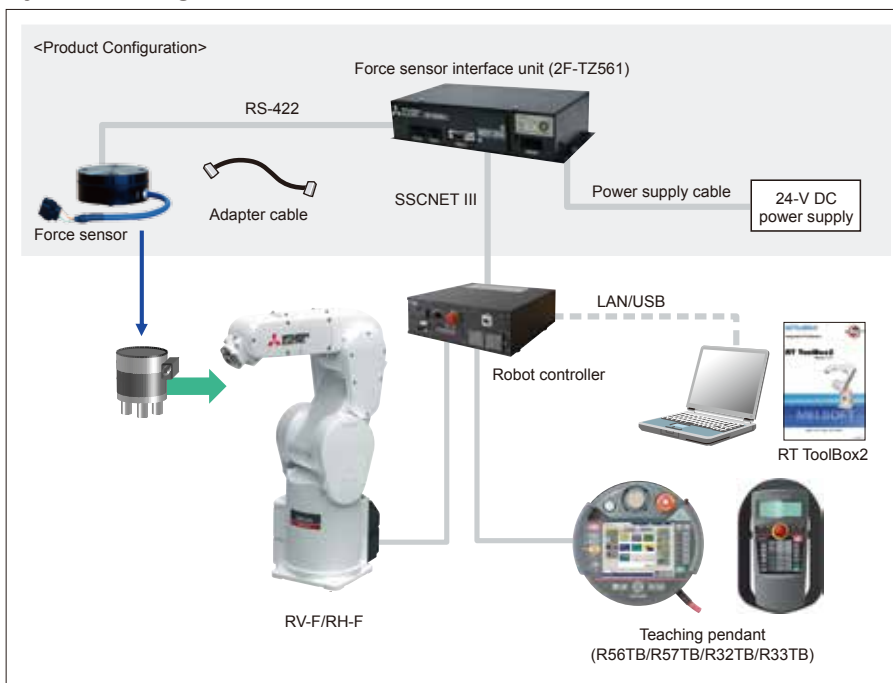

Force Sensor Specifications

Item	Unit	Specification Value
Rated load	Fx, Fy, Fz	N 200
	Mx, My, Mz	Nm 4
Max. static load	Fx, Fy, Fz	N 1000
	Mx, My, Mz	Nm 6
Breaking load	Fx, Fy, Fz	N 10000
	Mx, My, Mz	Nm 300
Minimum control force	Fx, Fy, Fz	N 0.3
	Mx, My, Mz	Nm 0.03
Consumption current	mA	200
Weight (sensor unit)	g	200
External dimensions	mm	φ 80 x 3.25
Protective structure	-	IP30

Force Sense Interface Unit Specifications

Item	Unit	Specification Value
Interface	RS-422	ch 1 (For sensor connection)
	SSCNET III	ch 1 (For robot controller and additional axis ampconnection)
Power supply	Input voltage	Vdc 24 ± 5%
	Power consumption	W 25
External dimensions	mm	225(W) x 111(D) x 48(H)
Weight	kg	Approx. 0.8
Construction	-	IP20 (Panel installation, opentype)

In-Sight (Manufactured by COGNEX: For Mitsubishi Electric FA devices)

The In-Sight software developed exclusively for use with Mitsubishi Electric FA devices with enhanced linking to In-Sight, the vision system produced by COGNEX Corporation, offers better compatibility with FA devices, allowing it to be utilized more easily as a more user-friendly vision system.

Simplified settings using Easy Builder

Easy Builder allows connection to vision systems, setting of job (vision programs) settings, and calibration between the robot and vision system to be completed easily and quickly.

Simplified connection using Ethernet

Up to three robots and seven vision systems can be connected together to the same system by Ethernet connection. Vision system information can be shared between multiple robots.

Simplified control using robot language

The included dedicated vision system commands enable vision system startup, job selection, and control of data receiving and other operations to be completed quickly and easily using a single command without any need for protocols.

Simplified job editing

Jobs (Vision recognition programs) are created from the job editing screen. Jobs can be edited using condition settings and other data, eliminating the need for specialized knowledge of vision control commands and other programming instructions.



Simplified calibration

The calibration wizard allows settings used in converting workpiece positions recognized by the vision system into robot coordinate system coordinates easily and quickly.

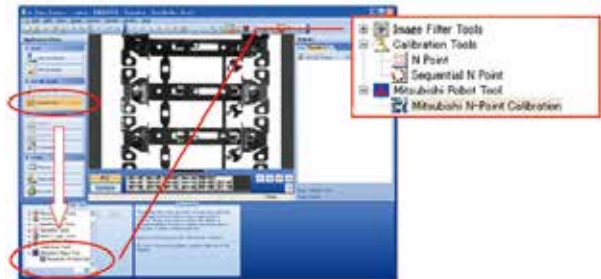

Robot controller specifications

Item	Specifications
Software	Robot controller: CR750 Series CRnQ-700 Series: R1 ver. or later CRnD-700 Series: S1 ver. or later RT ToolBox2: Ver. 1.0 or later recommended
Adapted robot controller	CR7xx/ CRnQ-7xx/ CRnD-7xx
Connected robot	All models
Number of robots connected to the vision system	Number of cameras used per robot controller: Up to 7 max. Number of robots that can be connected to a vision system: Up to 3 max.
Robot program language	MELFA-BASIC V comes with dedicated vision sensor commands

Model name -□□□	Entry	In-Sight Series						
		Standard			High resolution	Color		
	100	110	140	143	110C	140C	143C	
Performance and magnification	Average performance data setting that for the standard version to 1 (*2)	1x	2x	5x	4x	2x	5x	4x
Camera	Resolution	640x480	640x480	640x480	1600x1200	640x480	640x480	1600x1200
	CCD sensor size	1/3 in.	1/3 in.	1/3 in.	1/1.8 in.	1/3 in.	1/3 in.	1/1.8 in.
	Color	x	x	x	x	o	o	o

Simplified control using robot language

MELFA BASIC V comes with dedicated vision system control commands and status variables. These control commands and status variables enable the vision system to be controlled using simple programs.

Instruction word	Details
NVOpen	Connect to the vision system and log on.
NVPst	Start up the specified vision program and receive the transmitted results.
NVRun	Start up the specified vision program.
NVIn	Receive the transmitted results of the vision program specified by the NVRUN command.
NVClose	End the connection to the vision system.
NVLoad	Ready the specified vision program to enable it for startup.
NVTrg	Transmit a request to the vision system for the image and acquire the encoder values after the specified length of time.

Separate MELFA-Vision software is available for customers using In-Sight5000 series or In-Sight Micro series products. The use of job programs corresponding to work tasks performed regularly enables even customers who are new to vision systems to easily understand and use them without problems.

Options

Please contact your local representative or sales office.

Multifunctional Electric Hand Option

The multifunctional electric hand option supports customer's various applications with various functions, great lineup, and highly accurate gripping

Highly advanced control impossible with air cylinders

Grip force/speed setting according to the target workpiece

Grip patterns can be set according to the grip target, such as soft workpieces and heavy workpieces, with the torque specification and grip speed setting.

Operation stroke setting according to the shape of the target workpiece

Even when target workpieces are different in size, the optimal stroke can be specified with the operation position specification.

Easily applied to inspection, in addition to workpiece handling

Applications to inspection are possible with feedbacks of the torque or position of the hand, including whether a workpiece is gripped or not or whether a workpiece is acceptable or not with workpiece dimension measurement.

New applications will be available.

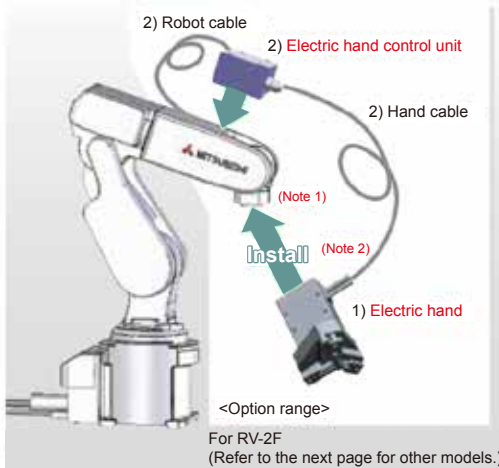

Components

	Name	Quantity	Remarks
1)	Electric hand	1	Select the model by the grip force and stroke.
	Electric hand control unit	1	Connected to the electric hand.
2)	Hand cable	1	Connects the electric hand and control unit.
	Robot cable	1	The cable type differs depending on the robot model.

Specifications of the electric hand control unit

Item	Specifications	Remarks
External dimensions	60 (W) x 60 (D) x 40 (H)	
Weight	Approx. 200 g	
Input power source	24 V DC \pm 10%, 1 A (max.)	Powered by the robot controller (Customers need to prepare no power supplies.)
No. of teaching points	32 points	Position data for multiple-point position control

* Only one model of the electric hand control unit is available for the electric hands.

(Note 1) To install the electric hand to a mechanical interface, fabricate an attachment separately.

(Note 2) The cable of the electric hand is not designed to be resistant to bending.

Take cautions to prevent any stress from applying to the cable while the robot is operating.

<Electric hand>

Item	Specifications	Exterior image	
2-claw type (4 models)	Max. grip force	5.0 to 150N	
	Grip force adjustment range	100 to 30% of the max. grip force	
	Stroke	3.2 to 38mm	
	Max. speed	100mm/s(Screw type : 50mm/s)	
	Min. speed	20mm/s	
	Max. grip weight	0.05 to 1.5kg	
	Repetitive stop accuracy	\pm 0.01 to 0.02mm	
Weight	90 to 890g		
2-claw type (1 models)	Max. grip force	2.0N	
	Grip force adjustment range	100 to 30% of the max. grip force	
	Stroke	13mm	
	Max. speed	100mm/s	
	Min. speed	20mm/s	
	Max. grip weight	0.02kg	
	Repetitive stop accuracy	\pm 0.03mm	
Weight	190g		

Type	Model	Stroke(mm)	Grip force(N)	
2-claw type	Single-cam type	4F-MEHGR-01	3.2	1.5 to 5
		4F-MEHGR-02	7.6	1.8 to 6
		4F-MEHGR-03	14.3	6.6 to 22
	Screw type	4F-MEHGR-04	38	45 to 150
3-claw type	4F-MEHGR-05	13	0.6 to 2	

Please contact your local representative or sales office.

Configuration requirement of the multi-function electric hand

RV-2F series

No.	Name: model	Quantity	Purchased at	Remarks
1	Electric hand	1	Mitsubishi Electric	Electric hand used by customers
2	Control unit for the electric hand: 4F-MEHCU-01	1	Mitsubishi Electric	
3	Electric hand installation flange	1	Fabricated by customers	Electric hand used by customers
4	Robot	1	Mitsubishi Electric	Standard specifications
5	Banding band/fixing plate	As required	Fabricated by customers	For fixing a cable

RV-4F/7F/20F series, external wiring specifications

No.	Name: model	Quantity	Purchased at	Remarks
1	Electric hand	1	Mitsubishi Electric	Electric hand used by customers
2	Control unit for the electric hand: 4F-MEHCU-02	1		
3	Adapter cable: 4F-MEHCBL-01	1		
4	Electric hand installation flange	1	Fabricated by customers	For fixing the tip of the electric hand
5	Electric hand control unit installation stand	1		For wiring from a forearm
Robot				
6	Robot, standard (external wiring) specifications	1	Mitsubishi Electric	Standard specifications External wiring sets (option) need to be connected to each of the forearm part and base part.
7	External wiring unit for the base	1		1F-HA01S-01: When the hand input signal and Ethernet signal are used together 1F-HA02S-01: When the force sensor signal and Ethernet signal are used together
8	External wiring unit for the forearm	1		1F-HA01S-01: When the hand input signal and Ethernet signal are used together 1F-HA02S-01: When the force sensor signal and Ethernet signal are used together
9	Wrist wiring internal-wiring specifications: RV-F-SH02/SH-03	1		Wrist wiring custom specifications SH-02: When the hand input signal and vision sensor signal are used together SH-03: When the force sensor signal and vision sensor signal are used together

RH-3/6/12/20F series

No.	Name: model	Quantity	Purchased at	Remarks	
1	Electric hand	1	Mitsubishi Electric	Electric hand used by customers	
2	Control unit for the electric hand: 4F-MEHCU-02	1			
3	Relay cable	1			
	RH-3FH35/45/5515 &C specifications Z=120 RH-6FH(M)(C)35/45/5520	4F-MEHCBL-02 (Length: 1300 + 150 mm)			1
	RH-6FH(M)(C)35/45/5534	4F-MEHCBL-03 (Length: 1600 + 150mm)			1
	RH-12FH(M)(C)55/70/8535 RH-20FH(M)(C)8535	4F-MEHCBL-04 (Length: 1800 + 150mm)			1
	RH-12FH(M)(C)55/70/8545 RH-20FH(M)(C)10035/45	4F-MEHCBL-05 (Length: 2100 + 150mm)	1		
7	Banding band, nylon clamp, etc.	1	Fabricated by customers	For fixing a cable	
8	Electric hand installation flange	1	Fabricated by customers	For fixing the shaft tip of the electric hand	

RV-4F/7F/13F/20F series, piping internal wiring specifications

Specifications	Possible hand configuration	Accessory		Remarks
		External wiring set for the forearm	External wiring set for the base	
-SH02	•Electric hand + hand input signal •Vision sensor	-	1F-HA01S-01	An external wiring set for the base is enclosed with the internal wiring type robot.
-SH03	•Electric hand •Vision sensor •Force sensor	-	1F-HA02S-01	

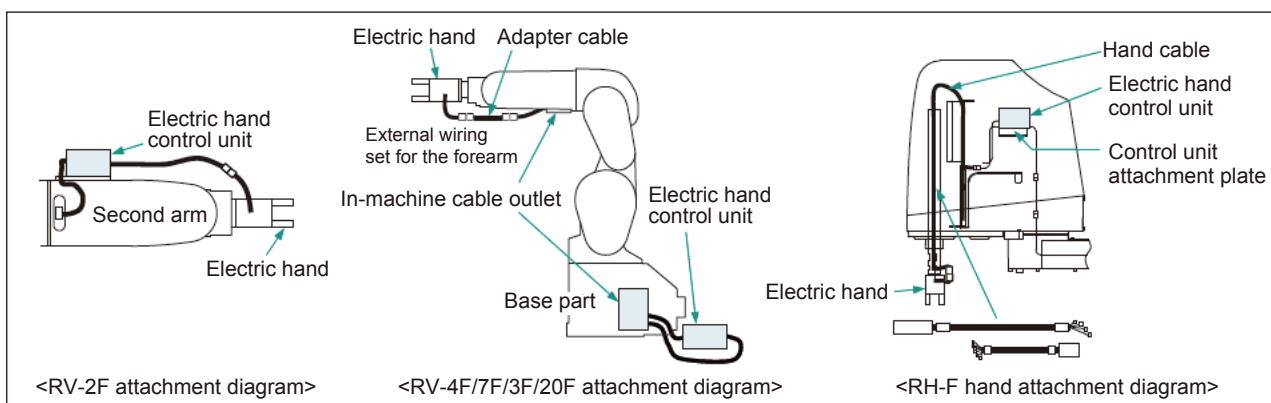

Options

Please contact your local representative or sales office.

MELFA-3D Vision

Model name 4F-3DVS2-PKG1

This 3D vision sensor for small robots is small and performs high-speed and high-accuracy measurements.

This sensor is optimal as a replacement for a parts feeder. Its unique model-less recognition processing enables high-speed picking.

Small and light

Since this sensor is small and light (Camera head part: 146 × 87 × 137 mm, approx. 0.9 kg), it can be used for eye-in-hand and can be fixed.

High-speed and high-accuracy measurement

This sensor enables high-speed recognition of 1.2 seconds at the earliest (model-less recognition) and high-accuracy measurements with the minimum measuring error of approximately 0.3 mm.

As a replacement for part feeders

- One of the following two recognition methods can be selected.
- Model-less recognition: The position of a workpiece is recognized without registering its model.
 - Model matching recognition: The pose of a workpiece is recognized using a 3D-CAD model. This sensor is more inexpensive and conserves a smaller footprint than a part feeder (when multiple parts are used). Retry operation can reduce stoppage.

Good connection compatibility supplied as a robot manufacturer

This sensor can be connected directly via LAN equipped with a controller as standard. The sensor can be set and its operation can be checked easily using a personal computer for setting. When the sensor is running, the personal computer is not required. The sensor has the coordinate calibration function of robots and vision sensors as standard installation. The dedicated commands added to MELFA-BASIC V can be used to control the sensor.

Product specifications

Item	Specifications	
Measurement method (*1)	Triangulation method (Pattern light projection type)	
Measurement time	Approx. 1.3 to 1.8 seconds	
Recognition method	Model-less: Workpiece registration-free method (4 degrees of freedom XYZC) Model matching: 3D-CAD utilizing method (6 degrees of freedom XYZABC)	
Recognition time (*2)	Model-less: Approx. 1.2 to 2 seconds Model matching: Approx. 3 to 5 seconds	
Measurement efficient points (*3)	Approx. 300000 to 600000 points	
Measurement viewing angle (*3)	Approx. 15 to 20 degrees	
Workpiece distance (*4)	300 to 1000 mm	
Measuring error (*3)	Approx. 0.3 mm or larger	
External dimensions (*5)	Camera head part (Minimum size, W is 3-step variable) 146 (W) × 87 (H) × 137 (D) mm Control unit part 430 (W) × 370 (H) × 98 (D) mm	
Weight	Approx. 0.9 kg (Camera head part) Approx. 12 kg (Control unit part)	
General specifications	Ambient temperature: 5 to 40 °C Ambient humidity: 45 to 85%RH, with no condensation Usage atmosphere: With no corrosive gas	
Input power source	Voltage range	Single phase 180 to 253 V AC
	Power source capacity	0.2 kVA

- *1) Shielding measures may be required depending on the usage environment, such as when surrounding environmental light affects the sensor.
- *2) The standard time from the recognition start to output. Depending on the conditions of surrounding environment, workpieces, and processing parameters, a time longer than the standard time may be taken.
- *3) The number of effective points varies depending on the conditions including the sensor installation distance and a lens used.
- *4) The range of the distance between the lens installation flange face and a position to be measured. All areas cannot be used at the same time. For details, refer to instruction manuals.
- *5) The size of the camera head part depends on the mounting base to be used.



Components

No.	Name	Quantity
1	Camera head (Attachment: Standard lens, dedicated signal cable, and power cable)	1
2	Mounting base set (S: Mounted before shipment, L: Included)	1
3	Control unit	1
4	Calibration block set	1
5	Package CD-ROM (Instruction manual, setup guide, etc.)	1

Products prepared by customers

Name	Description	Quantity
Personal computer for setting	RT ToolBox2 (Ver. 3.00A or later) has already been installed.	1
LAN cable	Category 5e or later (Refer to the product configuration diagrams.)	2

Precautions

- The following workpieces cannot be measured.
 - Transparent objects and mirror face objects
 - The following workpieces may be difficult to be measured or recognized.
 - High-gloss objects, black objects, or deep color objects
 - Workpiece size (Reference values)
 - Model-less : Short side = 1/25 of the viewing field size to Long side = 1/3 of the viewing field size
 - Model matching : Short side = 1/10 of the viewing field size to Long side = 1/3 of the viewing field size
- *The workpiece size depends on the conditions of the workpiece distance, sensor parameters, and the shape and surface of the workpiece. The reference values are based on our test condition. For details, refer to instruction manuals.
- Whether the measurement can be performed or not and the measurement accuracy depend on the usage environment. For details, please contact us.
 - For model-less picking, a 2D vision sensor may be required in addition to a 3D vision sensor.
 - The applicable model is the vertical, multiple-joint type RV-F Series only.

Product configuration

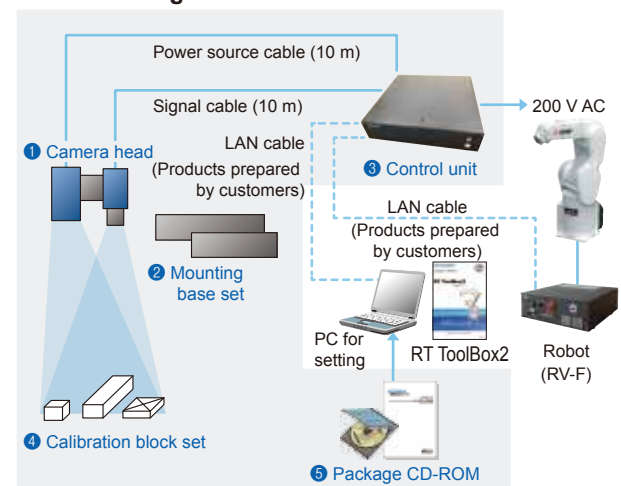

Safety Option

Feature

Operators can enter an operation area without stopping robots.

- High safety compliant with international standards
 - Robot's automatic operation continues even with a safety fence opened.
 - The newly installed safety input function enables safety doors to open without causing an emergency stop of the robot.
 - Operators and robots share an operation area. = They can cooperate.
 - While an operator is in a cooperative operation area, a robot doesn't approach the area. (operation range limit function)
 - Robots in cooperative operation keep the safety speed.
 - A robot in cooperative operation continues its operation at the safety speed to secure operator's safety.
 - Robots can automatically shift to single operation from cooperative operation.
 - Closing the safety door switches cooperative operation to single operation, and enables the robot to approach to the shared area.
- *Risk assessment and safety level proof need to be performed for the system.

Examples of safety options

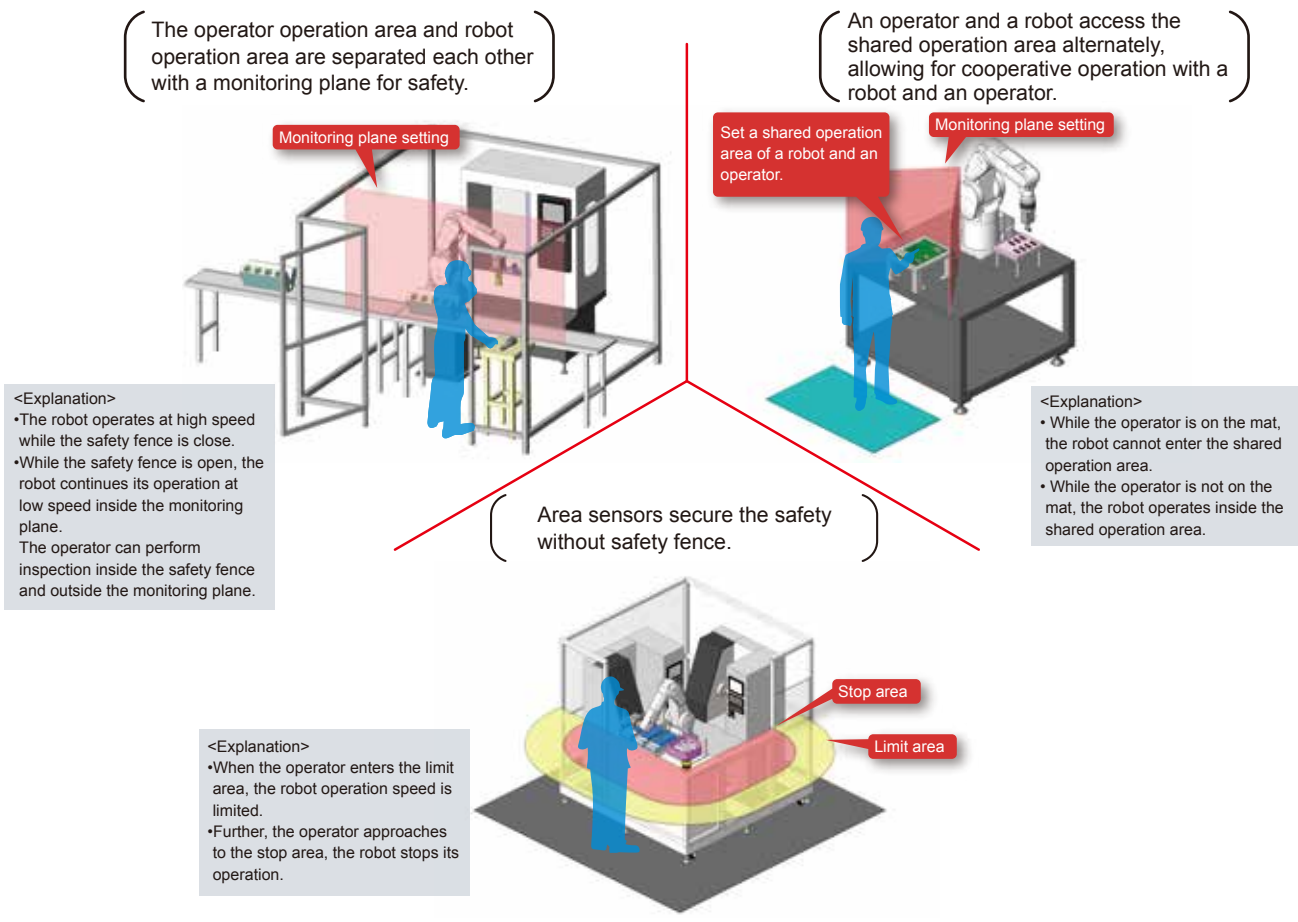

Item	Description	Remarks
STO function	Electronically shuts off the power to the motor of the robot.	Corresponds to the Stop category 0 of IEC 60204-1
SS1 function	Controls and decelerates the motor speed of the robot.	Corresponds to the Stop category 1 of IEC 60204-1
SLS function	Monitors the TCP speed not to exceed the monitoring speed.	Complies with EN61800-5-2
SLP function	Monitors a specified monitoring position not to exceed the position monitoring surface.	Complies with EN61800-5-2
STR function	Monitors the torque feedback not to exceed the allowable torque range.	Complies with EN61800-5-2

System configuration

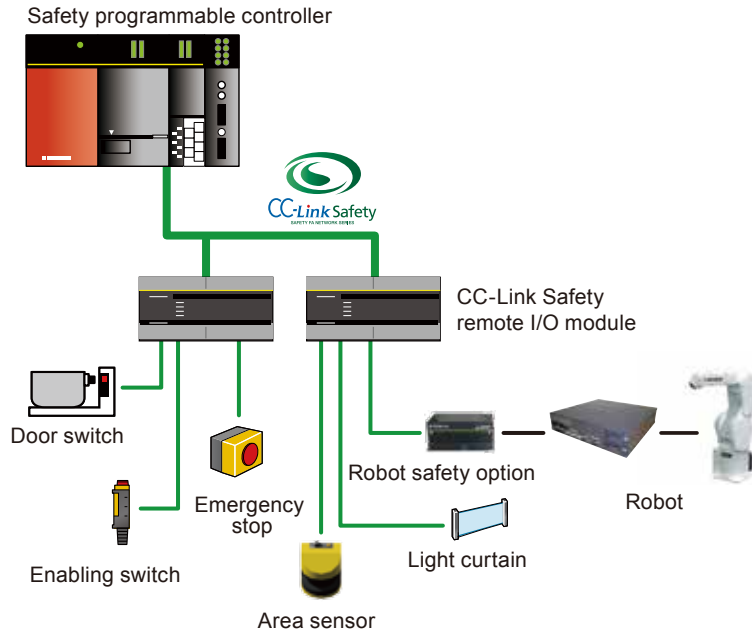

7

Easy setting

Parameter setting example of the safety function with the personal computer support software MELSOFT RT ToolBox2

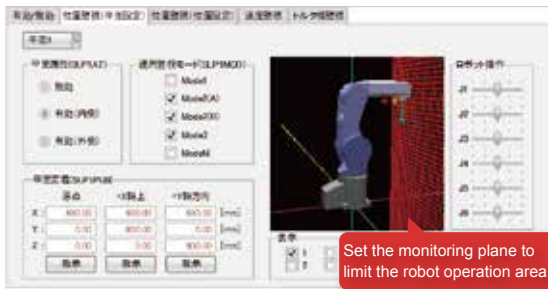

Position monitoring setting (plane setting)

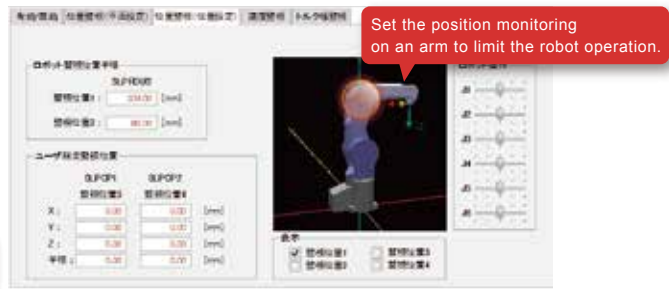

Position monitoring setting (position setting)

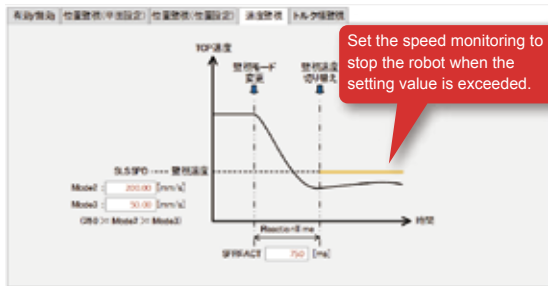

Speed monitoring setting

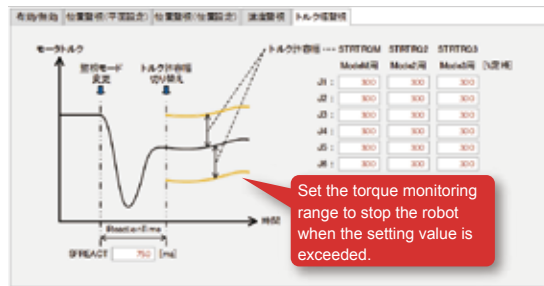

Torque monitoring setting

YOUR SOLUTION PARTNER

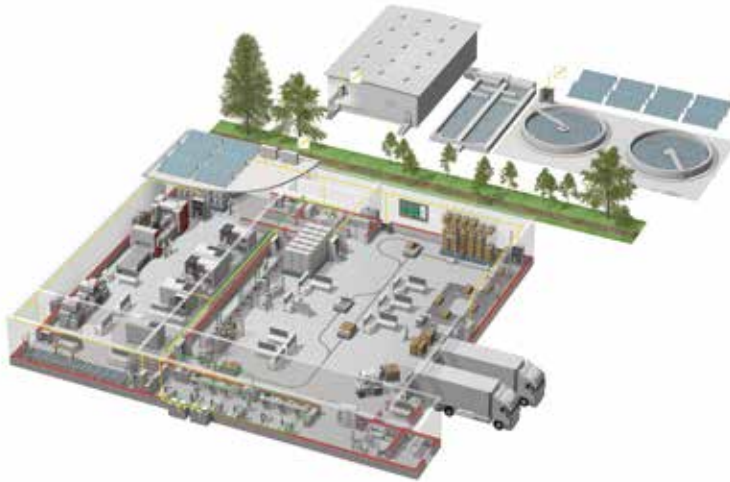

Mitsubishi Electric delivers a wide variety of FA products including FA devices, such as programmable controllers and AC servos, and industrial mechatronics products, such as CNC and industrial robots.

TO A MOST RELIABLE BRAND IN MANUFACTURING SITES

Mitsubishi Electric deploys various FA (factory automation) businesses covering from components to processing machines, and assists production systems in various fields for a goal of productivity improvement and quality improvement. With a system fully covering from development and manufacturing to quality assurance, Mitsubishi Electric is studying customer needs to produce products satisfying them.

Further, Mitsubishi Electric offers reliable and safe technical supports through its unique global network all over the world. The FA business of Mitsubishi Electric always offers the front-line solutions and contributes to the global manufacturing through close communication with customers.



Low voltage: MCCB, MCB, ACB



Medium voltage: VCB, VCC



Power monitoring, energy management



Compact and Modular Controllers



Inverters, Servos and Motors



Visualization: HMI, Software, MES connectivity



Numerical Control (NC)



Robots: SCARA, Articulated arm



Processing machines: EDM, Lasers, IDS



Air-conditioning, Photovoltaic, EDS

GLOBAL PARTNER. LOCAL FRIEND

American Offices

USA Mitsubishi Electric Automation, Inc. 500 Corporate Woods Parkway, Vernon Hills, IL 60061, USA. Tel: +1-847-478-2100	Brazil Mitsubishi Electric do Brasil Comercio e Servicos Ltda. Rua Jussara, 1750- Bloco B- Sala 01, Jardim Santa Cecilia, CEP 06465-070, Barueri - SP, Brasil Tel: +55-11-4689-3000
--	---

Asia-Pacific Offices

China Mitsubishi Electric Automation (China) Ltd. No.1386 Hongqiao Road, Mitsubishi Electric Automation Center 3F Shanghai, China Tel: +86-21-2322-3030	Taiwan Mitsubishi Electric Taiwan Co.,Ltd. 10F.No.88,Sec.6,Chung-Shan N.Rd.,Taipei,Taiwan Tel: +886-02-2833-5430	Korea Mitsubishi Electric Automation Korea Co., Ltd. 7F-9F, Gangseo Hangang Xi-tower A, 401, Yangcheon-ro, Gangseo-Gu,Seoul 157-801, Korea Tel: +82-2-3660-9550
Singapore Mitsubishi Electric Asia Pte. Ltd. 307 Alexandra Road #05-01/02, Mitsubishi Electric Building, Singapore Tel: +65-6470-2480	Thailand Mitsubishi Electric Automation (Thailand) Co., Ltd. Bang-Chan Industrial Estate No.111 Soi Serithai 54, T.Kannayao, Bangkok 10230 Thailand Tel: +66-2517-1326	India Mitsubishi Electric India Pvt. Ltd. Emerald House, EL -3, J Block, M.I.D.C., Bhosari, Pune - 411026, Maharashtra State, India Tel: +91-2710-2000

European Offices

Germany Mitsubishi Electric Europe B.V. German Branch Gothaer Strasse 8, D-40880 Ratingen, Germany Tel: +49-2102-486-0	UK Mitsubishi Electric Europe B.V. UK Branch Travellers Lane, Hatfield, Hertfordshire, AL10 8XB, U.K. Tel: +44-1707-27-6100	Italy Mitsubishi Electric Europe B.V. Italian Branch VIALE COLLEONI 7-20041 Agrate Brianza(Milano),Italy Tel: +39-039-60531
Spain Mitsubishi Electric Europe B.V. Spanish Branch Carretera de Rubi 76-80-AC.4720, E-08190 Sant Cugat del Valles (Barcelona), Spain Tel: +34-935-65-3131	France Mitsubishi Electric Europe B.V. French Branch 25, Boulevard des Bouvets, F-92741 Nanterre Cedex, France Tel: +33-1-5568-5568	Czech Republic Mitsubishi Electric Europe B.V. Czech Branch Avenir Business Park, Radicka 714/113a,158 00 praha5, Czech Republic Tel: +420-251-551-470
Poland Mitsubishi Electric Europe B.V. Polish Branch ul. Krakowska 50 32-083 Balice, Poland Tel: +48-12-630-4700	Ireland Mitsubishi Electric Europe B.V. Irish Branch Westgate Business Park, Ballymount. IRL-Dublin 24 Tel: +353-14198800	Russia Mitsubishi Electric Europe B.V. Russian Branch Moscow Office 52. bld. 3, Kosmodamianskaya nab., RU-115054, Moscow, Russia Tel: +7-495-721-2070



MITSUBISHI ELECTRIC CORPORATION

HEAD OFFICE: TOKYO BLDG., 2-7-3 MARUNOUCHI,
 CHIYODA-KU, TOKYO 100-8310, JAPAN