



reddot design award  
winner 2016



FACTORY AUTOMATION

# MELSEC iQ-R Series iQ Platform-compatible PAC

Bridging the next generation of automation

## MELSEC iQ-R series



**NEW** Module

- Slim type main base unit R32SB/R33SB/R35SB ..... P.150
- Slim type power supply module R61SP ..... P.150
- I/O module with safety functions  
RX40NC6S-TS/RX48PT20S-TS ..... P.77

**NEW** Function

- Support of MATLAB® and Simulink® ..... P.17
- Simulation of entire line/equipment operations ..... P.20
- Data flow analysis (AI analysis) ..... P.22

**NEW** Software

- MELSOFT VIXIO ..... P.143



## Automating the World



Our Factory Automation business is focused on "Automating the World" to make it a better, more sustainable environment supporting manufacturing and society, celebrating diversity and contributing towards an active and fulfilling role.

Mitsubishi Electric is involved in many areas including the following:

### **Energy and Electric Systems**

A wide range of power and electrical products from generators to large-scale displays.

### **Electronic Devices**

A wide portfolio of cutting-edge semiconductor devices for systems and products.

### **Home Appliance**

Dependable consumer products like air conditioners and home entertainment systems.

### **Information and Communication Systems**

Commercial and consumer-centric equipment, products and systems.

### **Industrial Automation Systems**

Maximizing productivity and efficiency with cutting-edge automation technology.



The Mitsubishi Electric Group is actively solving social issues, such as decarbonization and labor shortages, by providing production sites with energy-saving equipment and solutions that utilize automation systems, thereby helping towards a sustainable society.

<b>MELSEC history</b> .....	<b>4</b>
<b>MELSEC iQ-R Series concept</b> .....	<b>6</b>
<b>Solutions</b> .....	<b>8</b>
<b>Improve equipment performance and ability</b> .....	<b>8</b>
<b>Reduce engineering time</b> .....	<b>12</b>
<b>Smart factory</b> .....	<b>25</b>
<b>Enhance factory safety</b> .....	<b>38</b>
<b>Improve reliability of factories and infrastructure systems</b> .....	<b>42</b>
<b>For customers using the MELSEC-A/Q Series</b> .....	<b>46</b>
<b>Basic system configuration</b> .....	<b>48</b>
<b>Lineup</b> .....	<b>49</b>
<b>CPU modules</b> .....	<b>50</b>
<b>I/O modules</b> .....	<b>76</b>
<b>Analog, temperature input, and temperature control modules</b> .....	<b>84</b>
<b>Motion and positioning modules</b> .....	<b>96</b>
<b>High-speed counter, isolated pulse, and flexible high-speed I/O modules</b> .....	<b>102</b>
<b>FPGA modules</b> .....	<b>106</b>
<b>Network modules</b> .....	<b>108</b>
<b>Advanced information modules</b> .....	<b>130</b>
<b>Energy measuring module</b> .....	<b>137</b>
<b>Software</b> .....	<b>138</b>
<b>Factory automation partner products</b> .....	<b>144</b>
<b>Support</b> .....	<b>146</b>
<b>General specifications/software operating environment</b> .....	<b>149</b>
<b>Product list</b> .....	<b>150</b>

# MELSEC history Since 1973

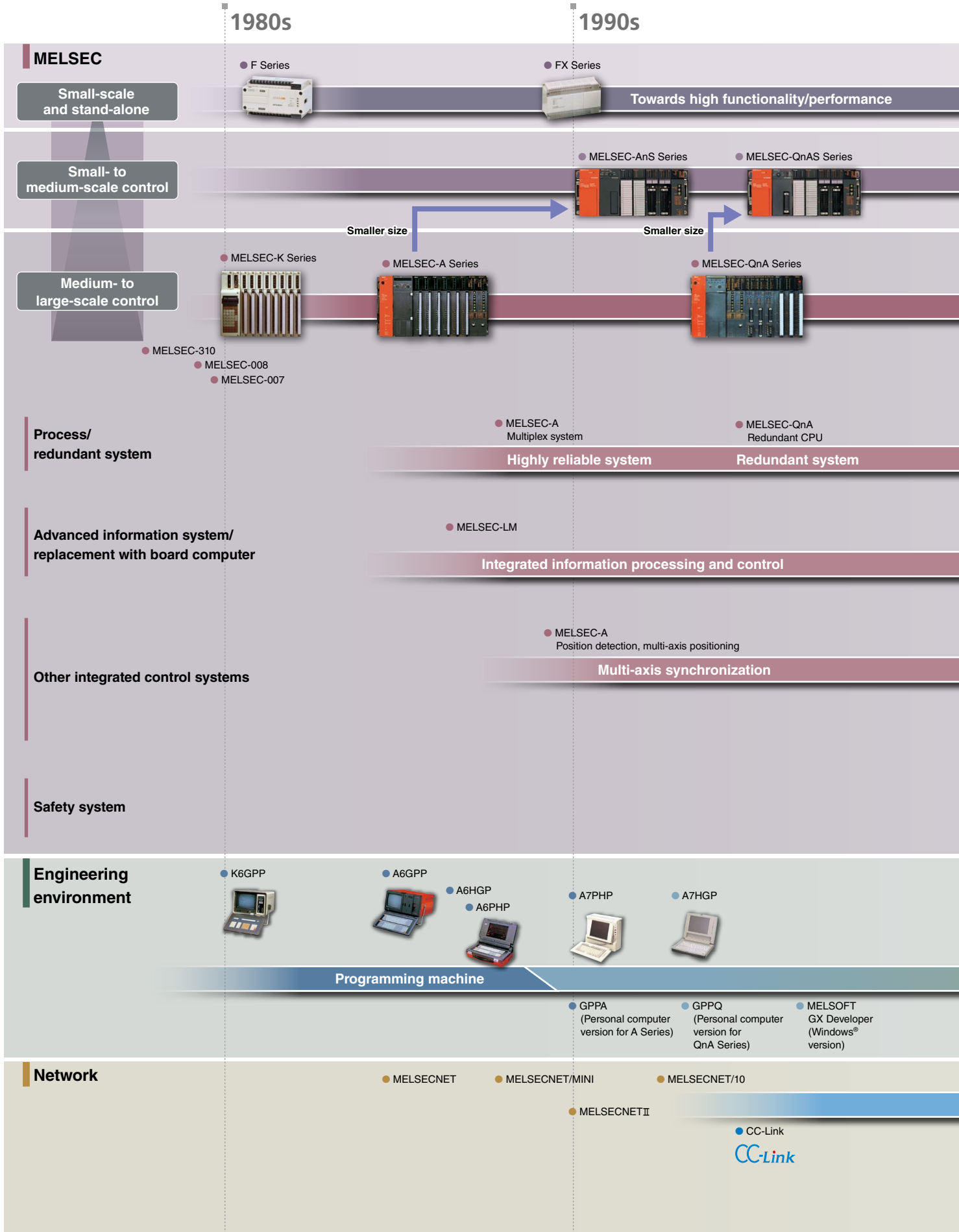

MELSEC with history and experience.  
Satisfying new challenges while utilizing past expertise.

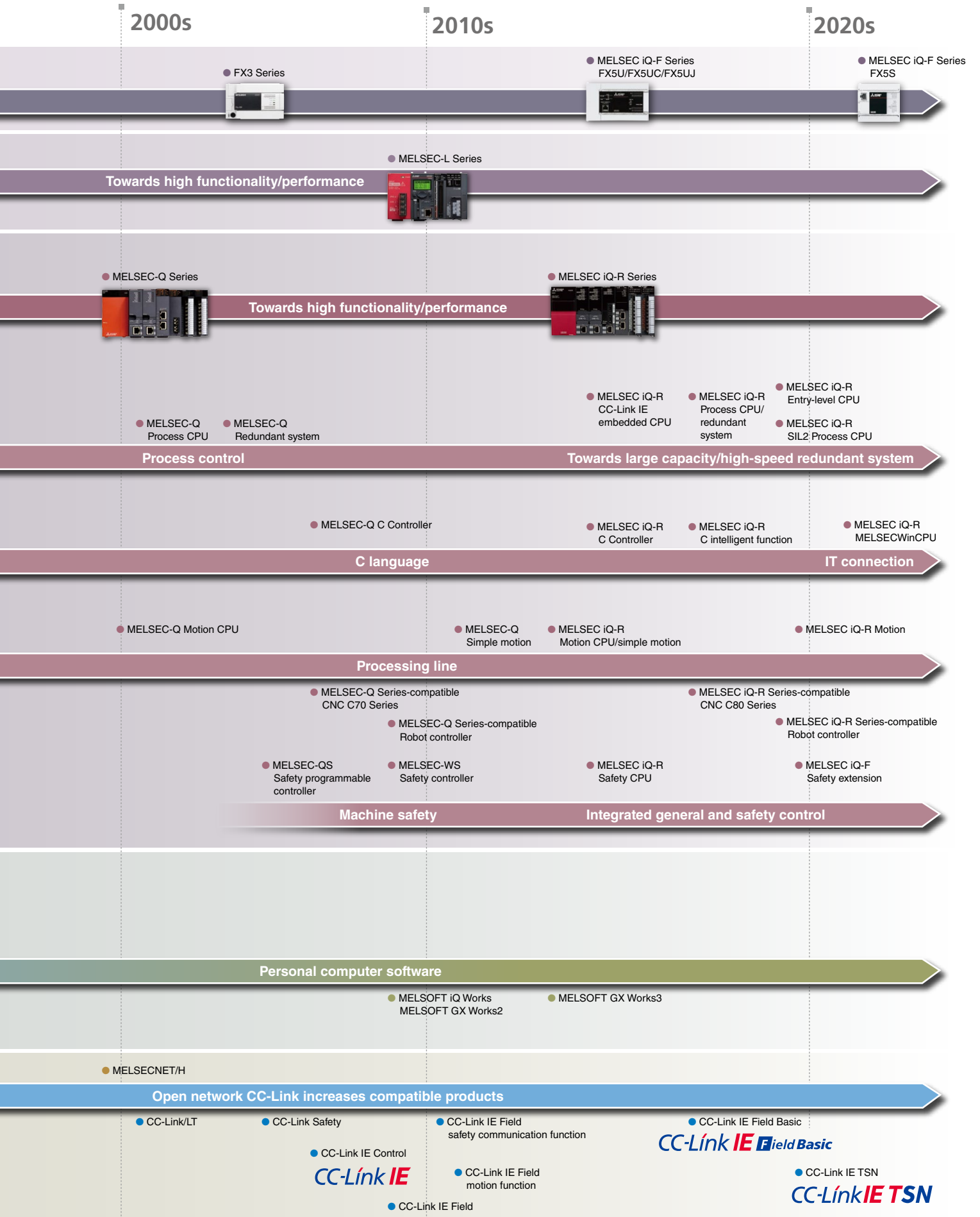

# Revolutionary, next-generation controllers building a new era in automation

## MELSEC iQ-R series

As the core for next-generation automation environment, realizing an automation controller with added value while reducing TCO\*1

To succeed in highly competitive markets, it's important to build automation systems that ensure high productivity and consistent product quality. The MELSEC iQ-R Series has been developed from the ground up based on common problems faced by customers and rationalizing them into seven key areas: Productivity, Engineering, Maintenance, Quality, Connectivity, Security and Compatibility. Mitsubishi Electric is taking a three-point approach to solving these problems: **Reducing TCO\*1**, increasing **Reliability** and **Reusability** of existing assets.

As a bridge to the next generation in automation, the MELSEC iQ-R Series is a driving force behind **revolutionary** progress in the future of manufacturing.

\*1. TCO: Total Cost of Ownership

### Process



**High availability process control in a scalable automation solution**

- Extensive visualization and data acquisition
- High availability across multiple levels
- Integrated process control software simplifies engineering

"Process" Movie



### Safety



**System design flexibility with integrated safety control**

- Integrated general and safety control
- Consolidated network topology
- Complies with international safety standards

"Safety" Movie



### Productivity



**Improve productivity through advanced performance/functionality**

- New high-speed system bus realizing shorter production cycle
- Super-high-accuracy motion control utilizing advanced multiple CPU features
- Inter-module synchronization resulting in increased processing accuracy

"Productivity" Movie



### Maintenance



**Reduce maintenance costs and downtime utilizing easier maintenance features**

- Visualize entire plant data in real-time
- Extensive preventative maintenance functions embedded into modules

"Maintenance" Movie



### Engineering

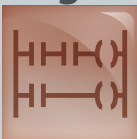

**Reducing development costs through intuitive engineering**

- Intuitive engineering environment covering the product development cycle
- Simple point-and-click programming architecture
- Understanding globalization by multiple language support

"Engineering" Movie



### Quality

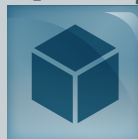

**Reliable and trusted MELSEC product quality**

- Robust design ideal for harsh industrial environments
- Improve and maintain actual manufacturing quality
- Conforms to main international standards

"Quality" Movie





Mitsubishi Electric PAC MELSEC iQ-R  
"Promotion" Movie



## Intelligence



Extensive data handling  
from shop floor to business  
process systems

"Intelligence"  
Movie



- Direct data collection and analysis
- C/C++ based programming
- Collect factory data in real-time
- Expand features using third-party partner applications

## Connectivity

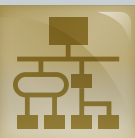

Open integrated  
networking across the  
manufacturing enterprise

CC-Link IETSN  
"IIoT system" Movie



CC-Link IETSN  
"Integrated motion"  
Movie



- High-speed/high-accuracy motion control reduces operating cycle time
- Flexible IIoT\*2 system configuration
- Improve system usability using intuitive engineering software

\*2. IIoT: Industrial Internet of Things

## Security



Robust security that can  
be relied on

"Security"  
Movie



- Protect intellectual property
- Unauthorized access protection across distributed control network

## Compatibility



Extensive compatibility  
with existing products

"Compatibility"  
Movie



- Utilize existing assets while taking advantage of cutting-edge technology
- Compatible with most existing MELSEC-Q Series I/O



Mitsubishi Electric FA Global website  
MELSEC iQ-R Series concept

MELSEC iQ-R

Search

[www.MitsubishiElectric.com/fa/products/cnt/plcr/pmerit/concept/index.html](http://www.MitsubishiElectric.com/fa/products/cnt/plcr/pmerit/concept/index.html)

The viewable page may vary depending on web browser and/or device (smartphone or tablet) used.

# Improve equipment performance and ability

## Customer's requirements

✓ Improve yield to process and produce efficiently

Point 1 Point 3 Point 4

✓ Handle high-mix low-volume production with a single equipment

Point 2

✓ Increase equipment security to reduce risk of program theft and data breach by hacking

Point 5





**Point 1** Ensuring latest functional version module

- Up to now, obtaining the latest features new module versions offered required purchasing another module. By utilizing the new module firmware update function, the MELSEC iQ-R Series current modules can be updated to newer versions enabling support of newer features without the cost of replacing the module
- Update is possible using the engineering software GX Works3 or an SD memory card

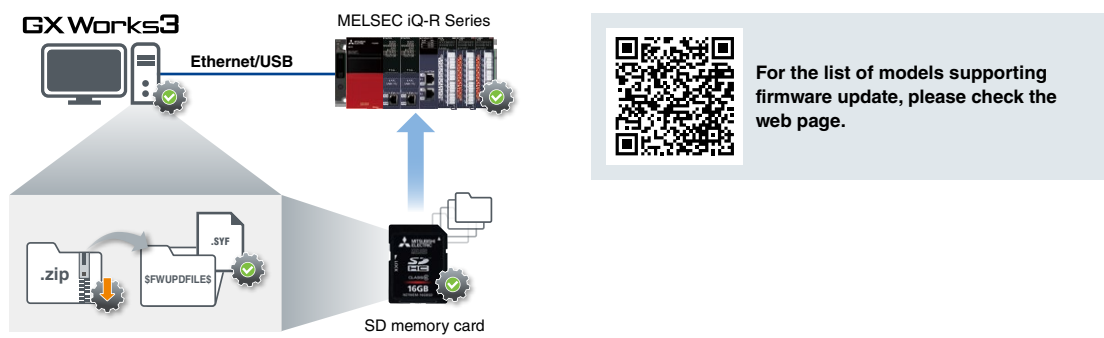

**Productivity improvement**

Productivity can be improved by utilizing the MELSEC iQ-R Series CPU module functions and high-speed integrated network CC-Link IE TSN.

**Point 2** High-speed/high-accuracy processing can improve productivity

- The high-speed system bus is approx. 40-times faster compared to existing models, achieving very fast and large-capacity data processing between CPU modules or network modules
- The inter-module synchronization function allows the input or output timing of various I/O modules and advanced information modules to be synchronized with the program execution timing of CPU modules. This realizes high accuracy control of the system and equipment
- Use of the CC-Link IE TSN realizes network-level synchronization, providing node-level synchronization that ensures deterministic data flow void of any influence from data transmission delays

▶ For details on CC-Link IE TSN, please refer to the "CC-Link IE TSN Product Catalog (L(NA)08656ENG)";

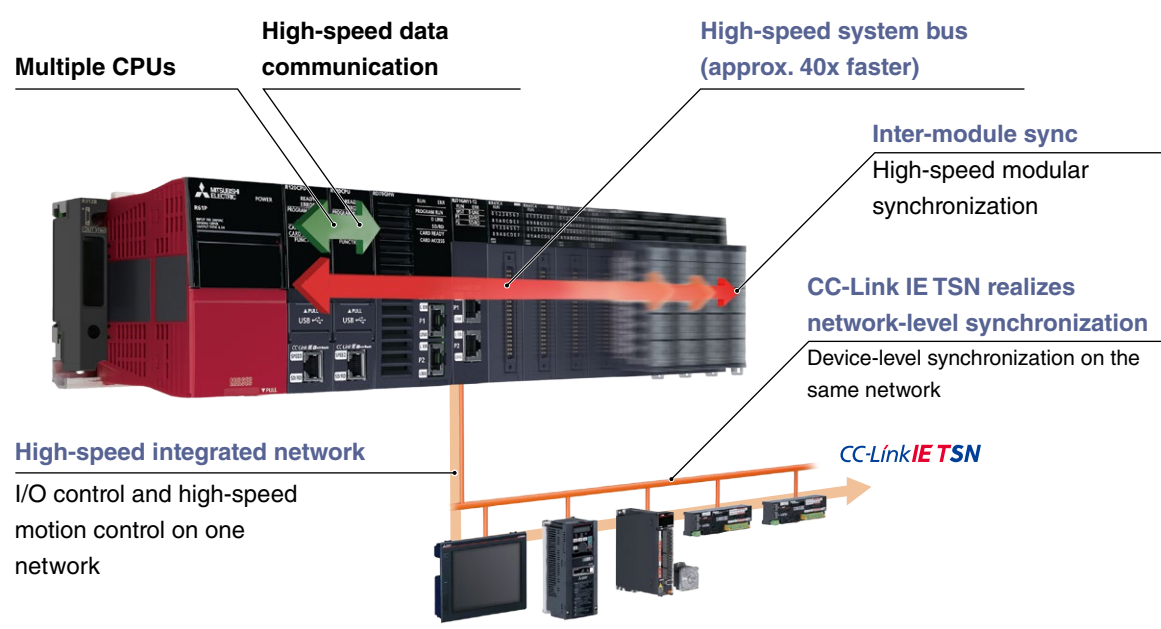

## Troubleshooting

Mitsubishi Electric proposes enhanced maintenance solutions for prompt troubleshooting of equipment and program error. Efficient troubleshooting can minimize downtime of equipment, reducing time and cost for recovery.

Point  
3

### System recorder identifies anomaly patterns from video feeds

- In coordination with the camera recorder module and engineering software GX VideoViewer Pro, differences from normal patterns are extracted according to changes in “appearance (color, shape, position, etc.)” and “operation (amount of travel in unit time, etc.)”, then marked on the video feed automatically
- Target device and labels to be recorded can be set with extensive triggers, allowing to check the target only

► For details on system recorder and GX VideoViewer Pro, please refer to the “System Recorder Catalog (L(NA)08736ENG)”

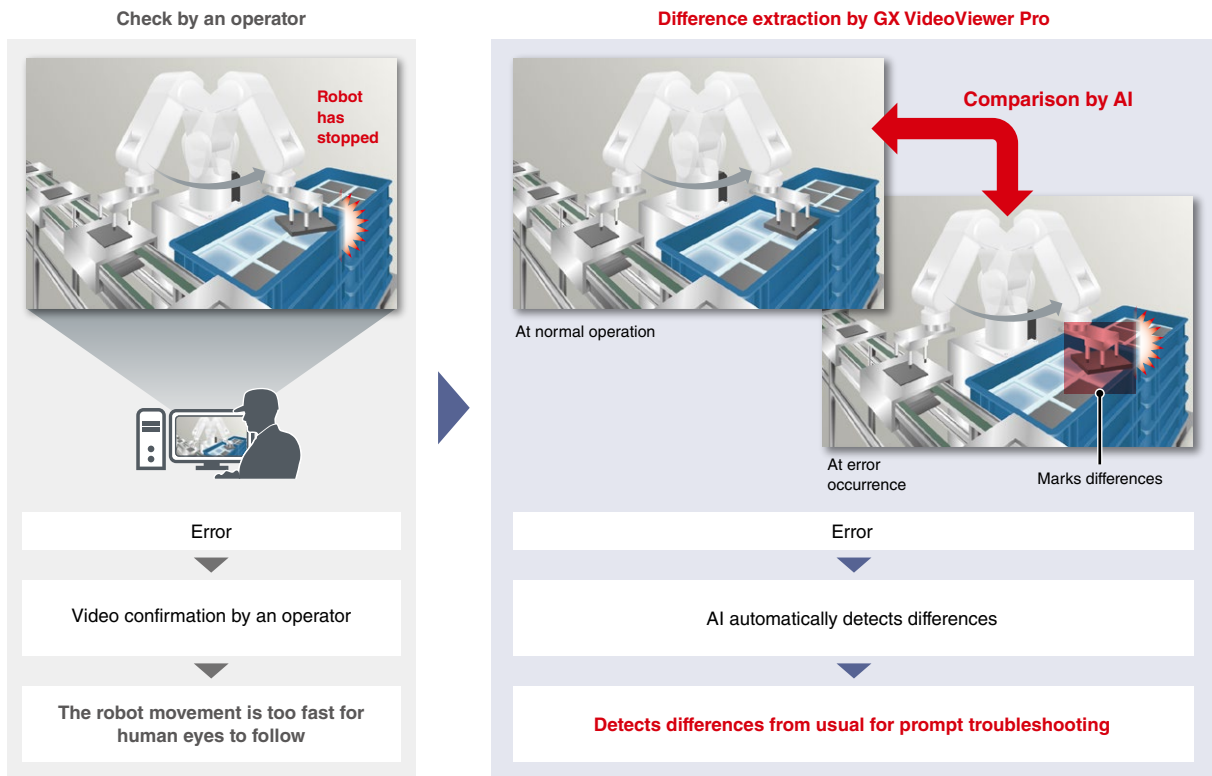

Point 4

The system recorder allows quicker debugging of equipment

- By replaying the system-wide recording data synchronizing with a program, the error status of equipment can be checked in time-series
- A cause of unexpected operations at equipment startup can be visually analyzed, allowing prompt debugging of the equipment

▶ For details on the system recorder, please refer to the "System Recorder Catalog (L(NA)08736ENG)"

Time synchronization

**Offline monitor**  
Check for device status at an error

**Seek bar**  
Intuitive operation allows you to jump to the screen where an error occurs

**Data flow analysis**  
Check for FB\*\* starting device

**Event history**  
Check the starting FB\*\* for each event

Identify anomaly from waveform

\*1. FB: Function Block

Security enhancement

The risk of data breach can be lowered with functions such as security key and IP filter.

Point 5

Enhanced security authentication and unauthorized access blocking reduce the risk of data breach

- The CPU module can be accessed only from the computer whose IP address is registered (IP filter function)
- Programs can be locked to prevent from being opened on computers where the security key has not been registered (security key authentication function)
- Each Program Organization Unit (POU) can be locked (block password function)
- Access from non-registered devices can be blocked, thereby lowering the risk of program hacking and unauthorized tampering by a third party

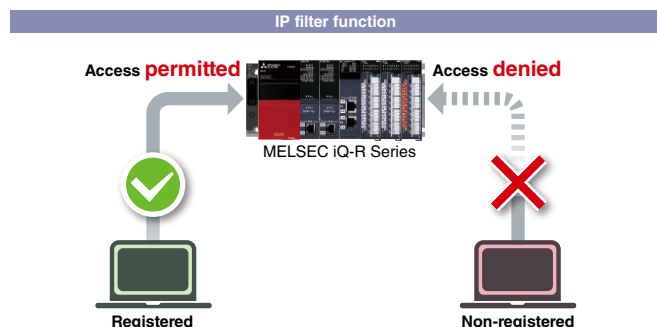

# Reduce engineering time

## Customer's requirements

✓ Quickly check device combinations compatibility for efficient selection

Point 1

✓ Reduce designing and engineering time

Point 2

Point 4

Point 8

Point 12

Point 13

Point 15

✓ Utilize created programs

Point 3

Point 5

Point 6

Point 7

Point 10

Point 11

✓ Reduce the time to identify the error cause

Point 14

Point 16

Point 17

Point 18

Point 19

✓ Utilize MELSEC-Q Series programs

Point 9



## Reduce engineering time per process

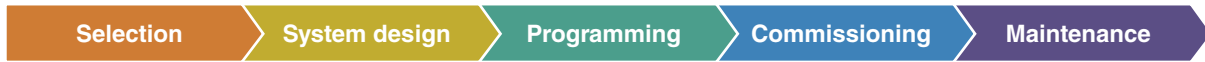

### Quick device selection

With FA Integrated Selection Tool, it is possible to check product combinations without referring to manuals. A “selection result” that is convenient when requesting a purchase quote can also be created. The tool is available on the browser from the Mitsubishi Electric FA Global website.



**Point 1** Significantly reduce the time for selecting devices and combinations



- Combinations of modules and options selected can be simulated. Restrictions such as consumption current and number of installable modules can also be checked
- Selected product name, model, and quantity are exported in Excel® format. The list can be printed out for consideration of the purchase

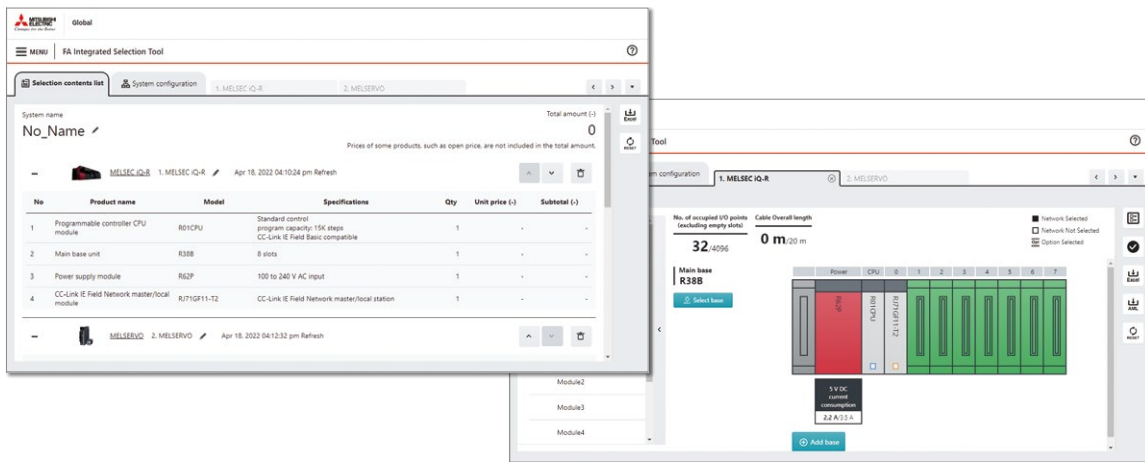

- The selected result can be exported in AutomationML format and imported to the engineering software MELSOFT Navigator
- Can quickly move to the design phase based on the imported selection results

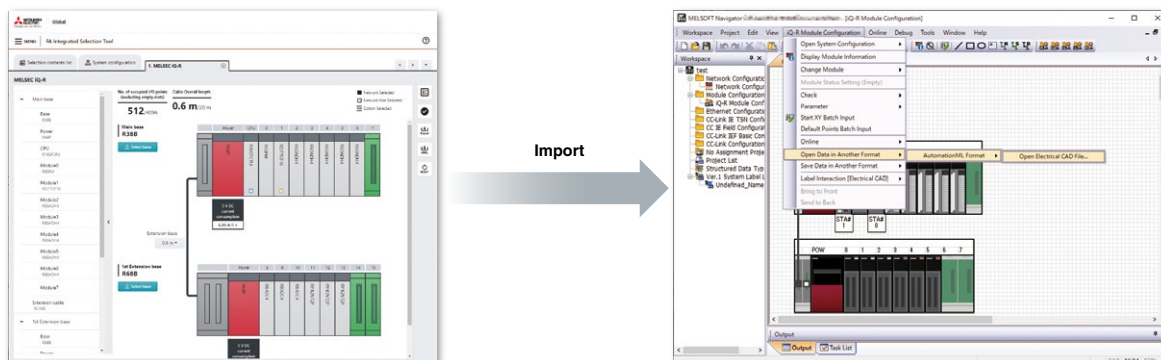

## Simple point and click programming architecture

GX Works3 is the programming and maintenance software specifically designed for the MELSEC iQ-R Series. With its various functions and intuitive operability, engineering time can be reduced.

# GX Works3 One Software, Many Possibilities

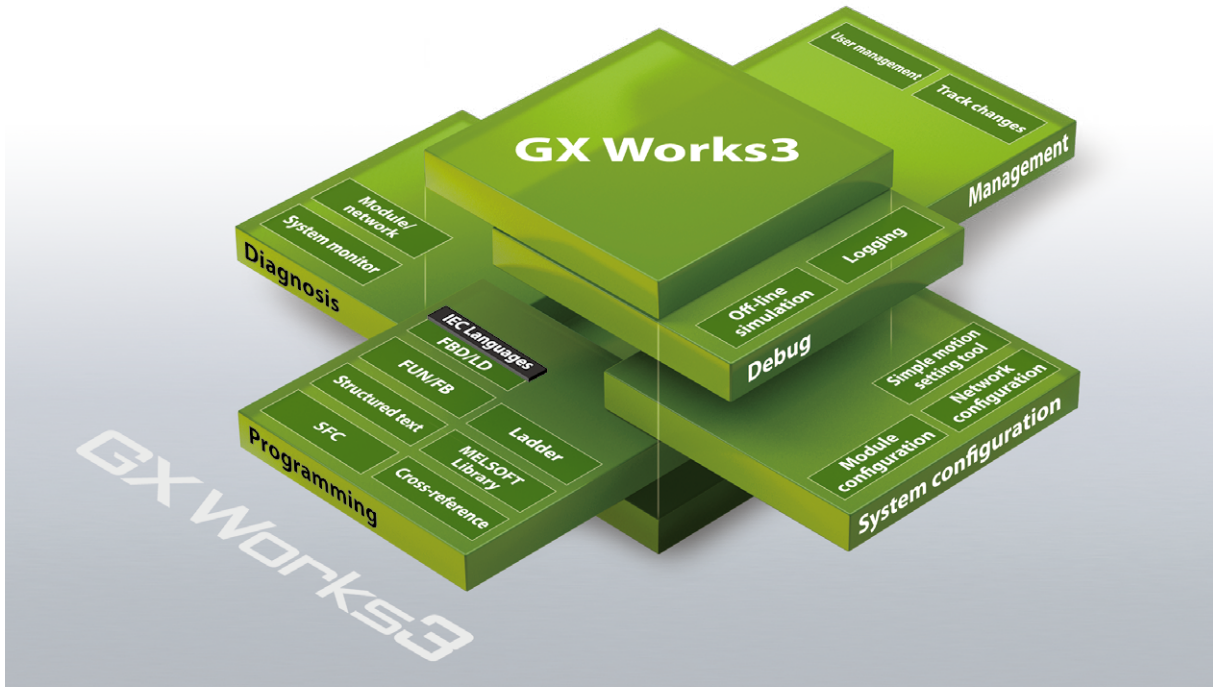

One software covers the product development cycle, from the design stage all the way to maintenance of the control system.

System design	Programming	Commissioning	Maintenance
<ul style="list-style-type: none"> <li>• Easy system configuration with parts library</li> <li>• Easy work sharing with structured programs</li> <li>• Integrated motion modules setup</li> </ul>	<ul style="list-style-type: none"> <li>• Complies with IEC 61131-3 and supports 5 main programming languages</li> <li>• Easy creation of function blocks</li> </ul>	<ul style="list-style-type: none"> <li>• Simulation without a device required</li> <li>• Quick search</li> <li>• Data flow analysis</li> <li>• Scan time clear function</li> </ul>	<ul style="list-style-type: none"> <li>• Module and network diagnostics</li> <li>• Multi-language commenting</li> </ul>

Point 2

Setup can be done by simply arranging modules



- GX Works3 incorporates features that enable module configuration and I/O assignment parameter registration by simply dragging and dropping components
- Simply double-click on the desired module, the corresponding parameters will be registered in the project
- System design is easily completed in one screen, reducing engineering time

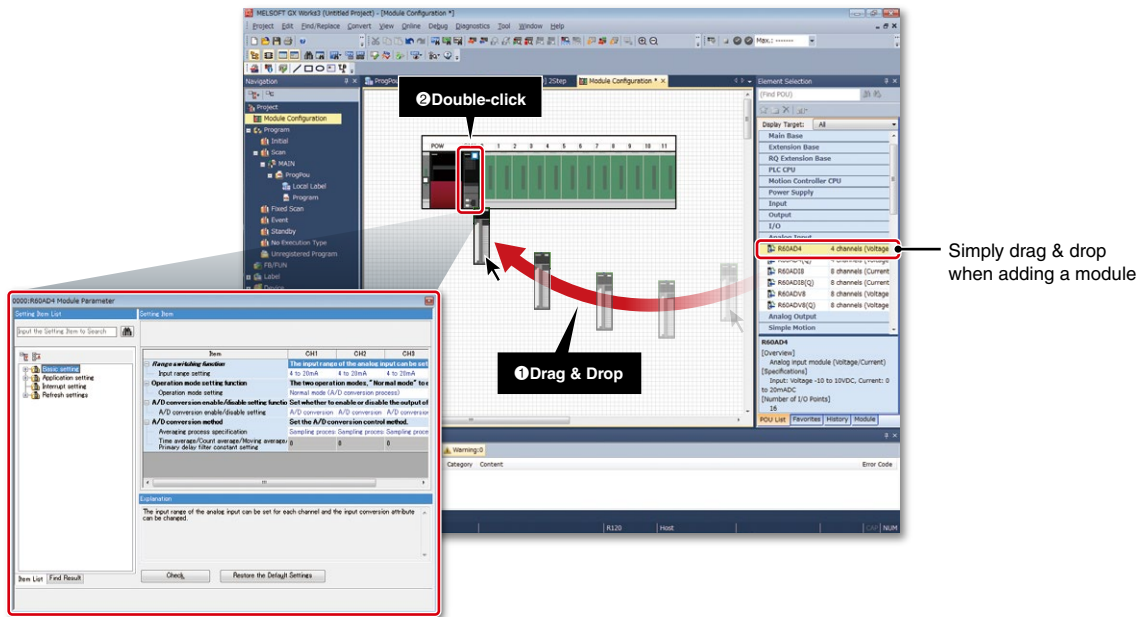

Point 3

Utilization of programs and collaboration on system design



- Structured projects and structure management enable utilization of programs and collaboration on system design
- Since program changes made by others are quickly reflected and revision histories are centrally managed, tracking changes is easy

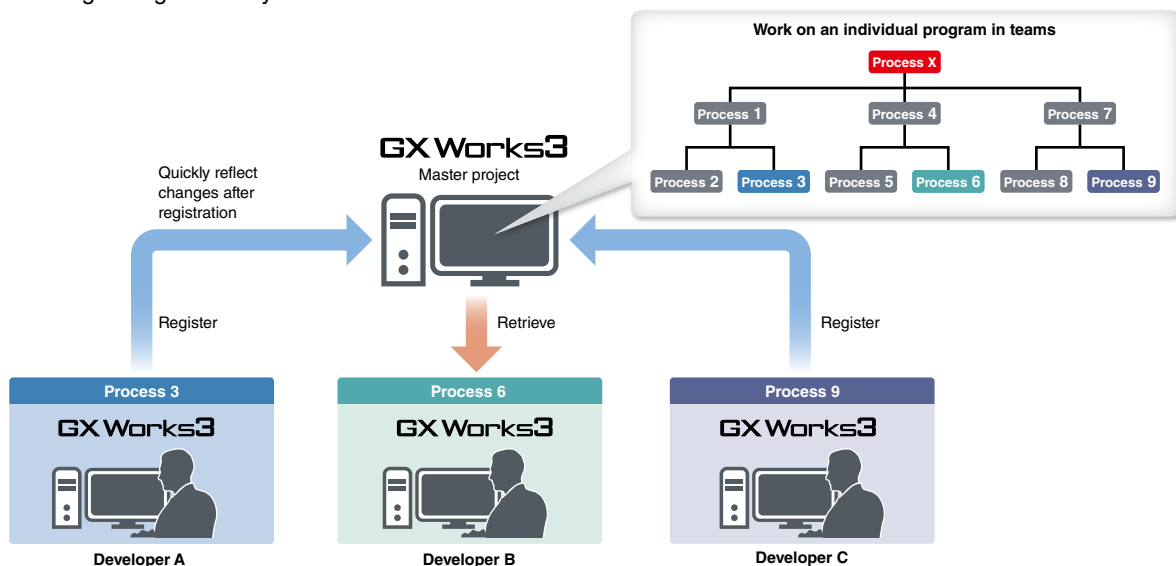

**Point 4**

**Motion related module setup with GX Works3 only**

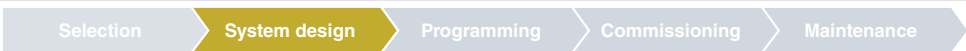

GX Works3 is equipped with a special motion setup tool that makes it easy to change motion module and simple motion module settings such as module parameters, positioning data and servo parameters

Project window  
Easy to use navigation pane

Cam data  
Fine-tune cam curve data

Simple motion module setting screen

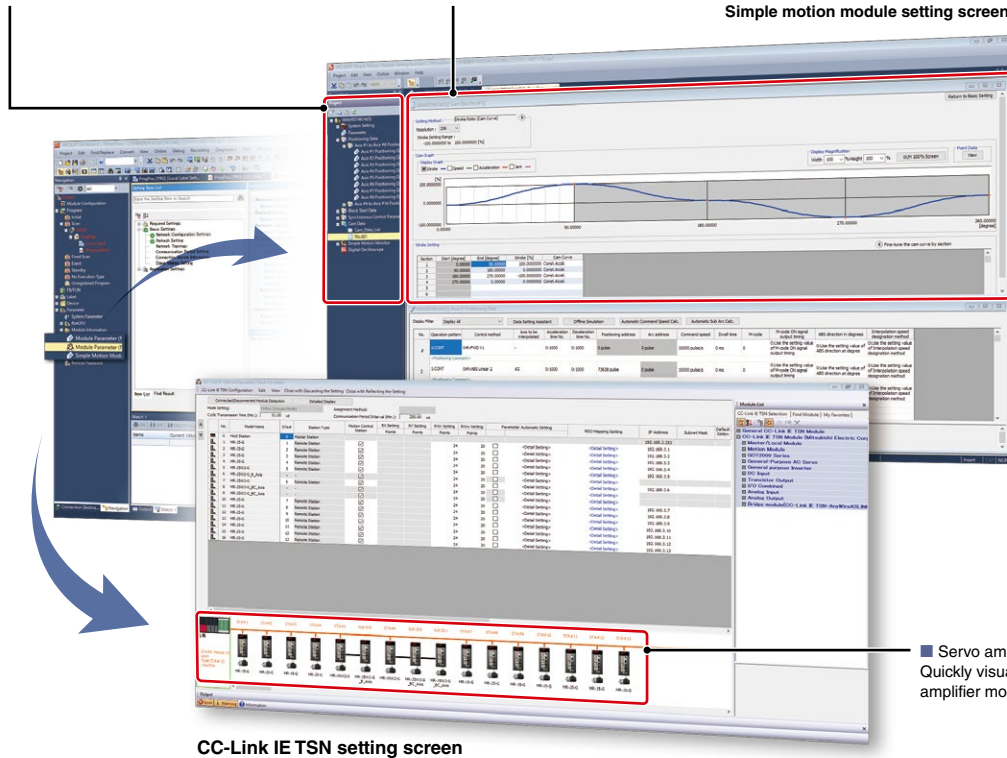

Servo amplifier information  
Quickly visualize type of servo amplifier model

CC-Link IE TSN setting screen



**Point 5**

The use of MATLAB® and Simulink® eliminates the need for programming, reducing equipment commissioning costs **NEW**

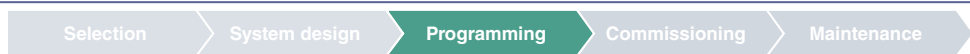

- Automatic code generation from model-based development allows complex algorithms to operate without manual coding
- Validation using the simulation capabilities of MATLAB® and Simulink® reduces commissioning time and costs

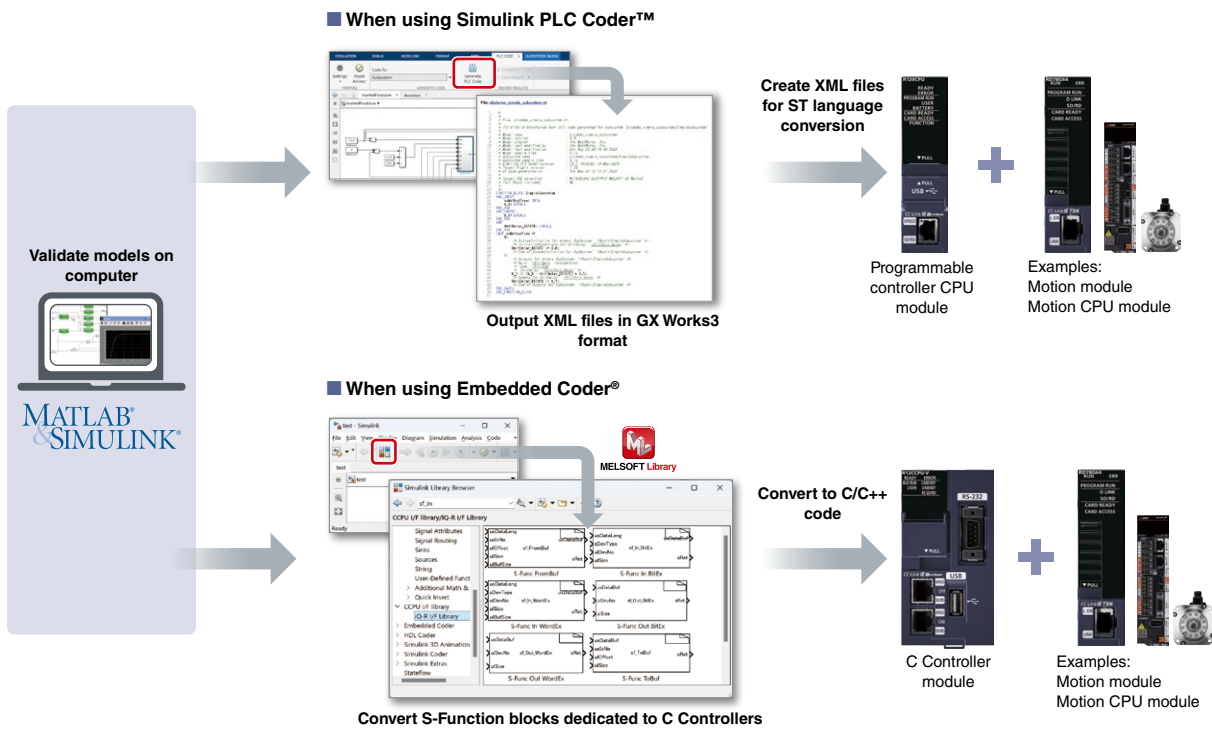



mathworks.com  
 Partner

**Point 6**

Efficient programming utilizing similar ladder circuits

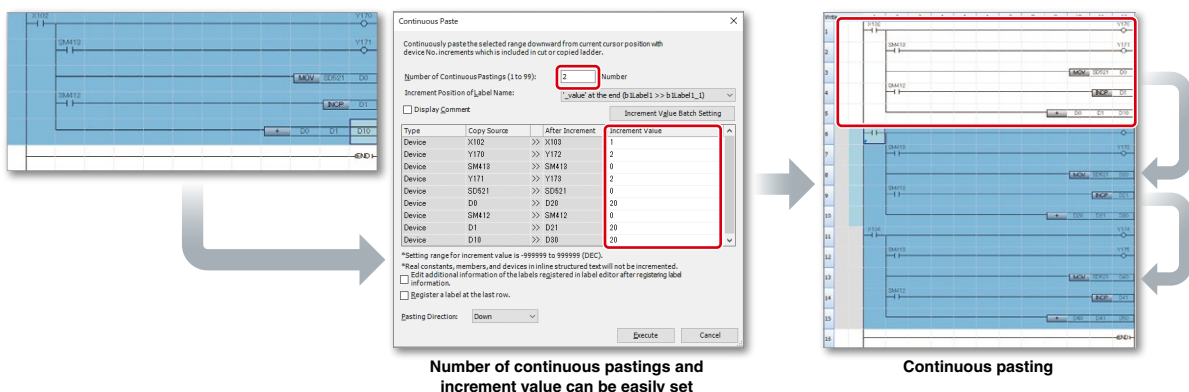

- Increment device numbers to paste continuously
- If one standard circuit is created, it will be duplicated in a batch using a continuous pasting function



**Point 7**

**Utilization of segmented programs**

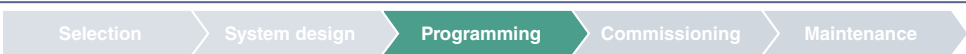

- By segmenting a control program into components (function blocks), intuitive and highly diverting programming (structured programming) is possible
- When segmented program components are registered as library, utilization of segmented programs is easier, thereby reducing programming time

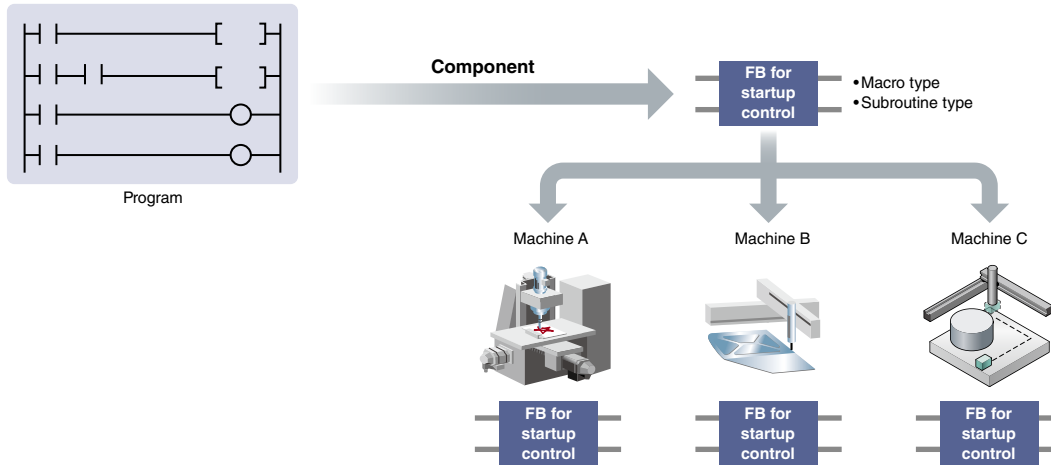

Program components (FB/FUN) are available. For details on how to obtain program components, please contact your local Mitsubishi Electric sales office or representative.

■ Third-party partner FBs

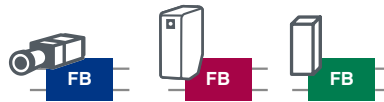

■ Module FBs (for Mitsubishi Electric products)



**Point 8**

**Function blocks (FBs) can be created from existing device programs**

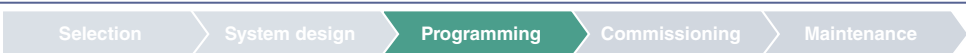

- Repeatedly used ladder circuits in the existing programs are segmented into components (function blocks) for utilization
- Programs can be shortened by representing lengthy processing in ladder circuits as functions

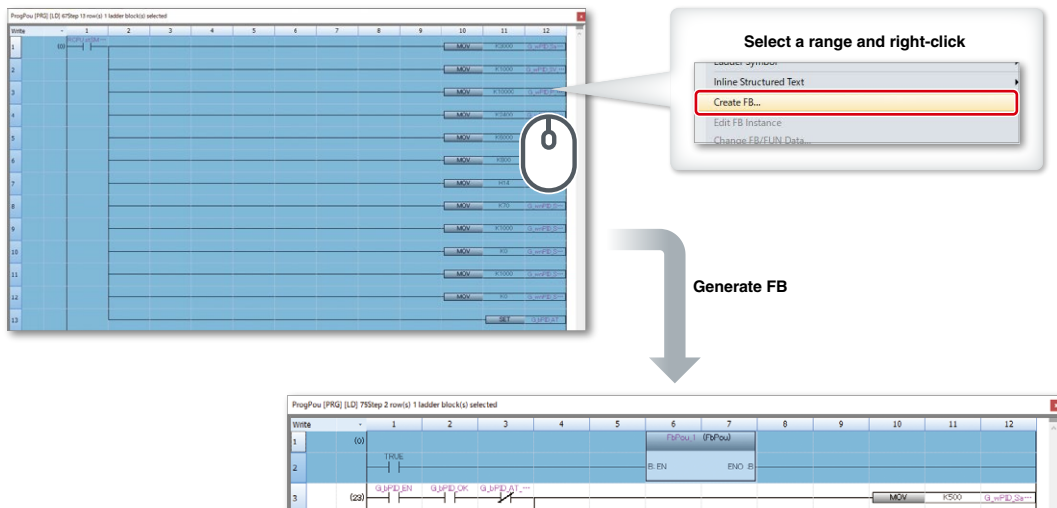

Point 9

Sample programs enable test operation of a device and demonstration machine

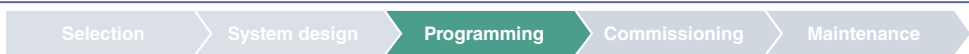

- Using e-Manual Viewer\*1, it is possible to directly copy sample programs within manuals and paste them to GX Works3
- Execution of copied sample programs enables test operation of a device and demonstration machine

\*1. The e-Manual Viewer is a next-generation digital manual that consolidates factory automation products manuals into an easy-to-use package with various useful features integrated into the viewer.

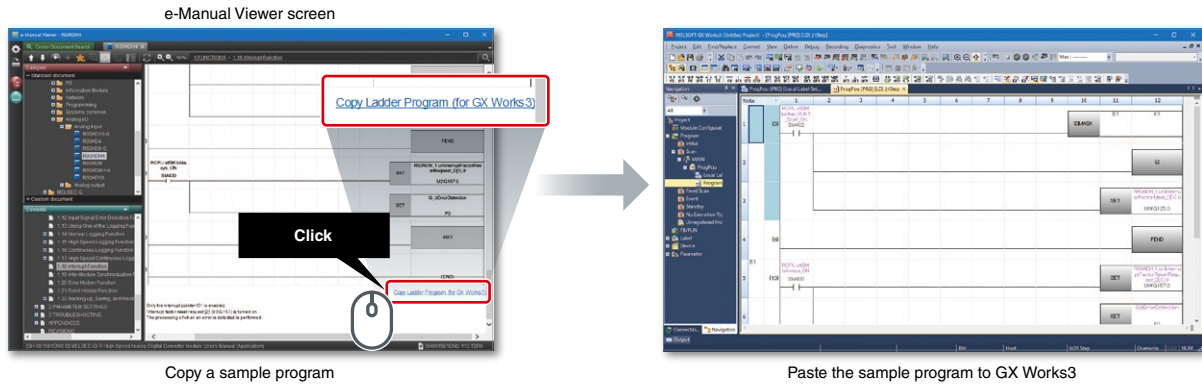

Windows®-compliant



Point 10

Utilization of the MELSEC-Q Series programs reduces programming time

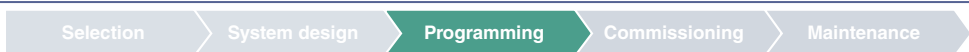

- MELSEC-Q Series programs can be utilized, eliminating the need to create a new program\*2
- The MELSEC-Q Series programs created with GX Works2 can be converted to the MELSEC iQ-R Series programs by simply opening them in GX Works3

\*2. MELSEC-A Series programs can also be converted to the MELSEC iQ-R Series programs. Lineup of useful tools for conversion is available.



Project migration steps movie

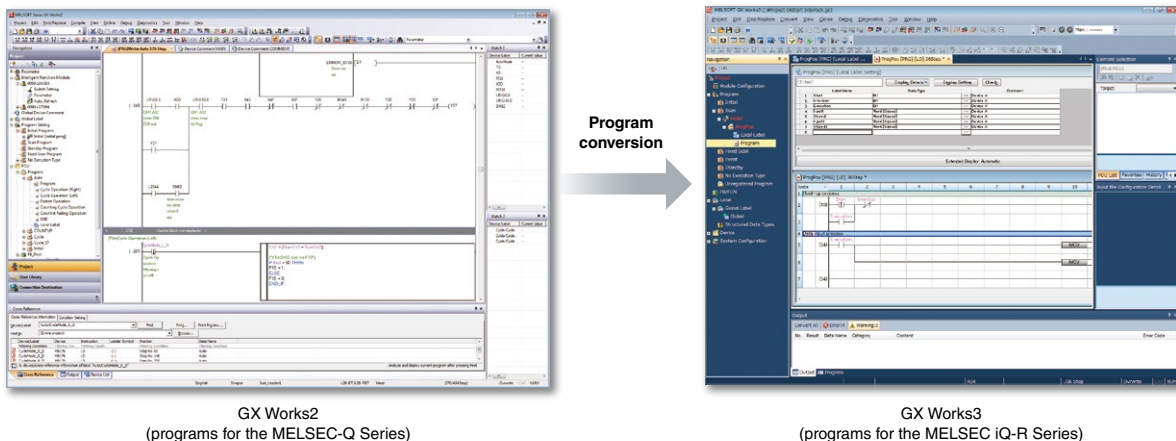

Point 11

Simulate the operations of the entire line or equipment without physical devices **NEW**

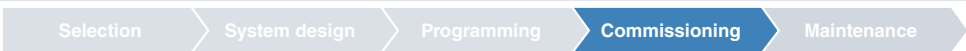

By linking the 3D simulator MELSOFT Gemini and the logic simulator MELSOFT Mirror, the execution results of control programs can be visualized in 3D, enabling the simulation of entire line or equipment operations without physical devices

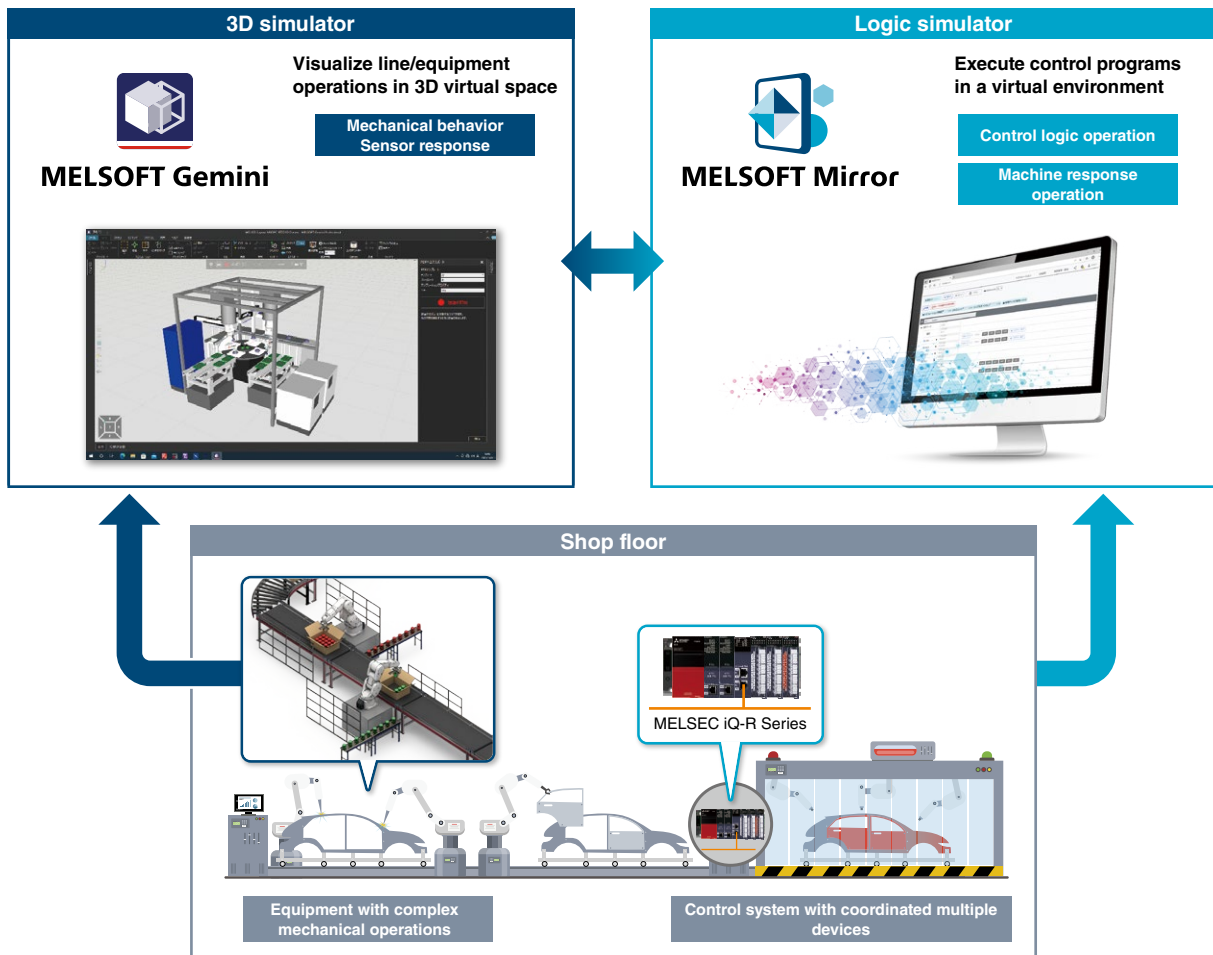

3D simulator

**MELSOFT Gemini**

A simulator that enables 3D validation of lines and equipment in a digital space. Machine interference and cycle time can be verified based on control programs.



MELSOFT Gemini product promotion



Logic simulator

**MELSOFT Mirror**

(Currently available in Japan)

A simulator that allows validation of control logic for lines and equipment in a digital space. Validation that takes into account multiple programmable controllers, networks, and mechanical responses helps develop high accuracy control programs efficiently.

**Point 12**

**Simulate operation even before having devices**

- Simulation is possible on GX Works3 without devices required
- Test before having devices reduces rework
- Motion control can be simulated as well

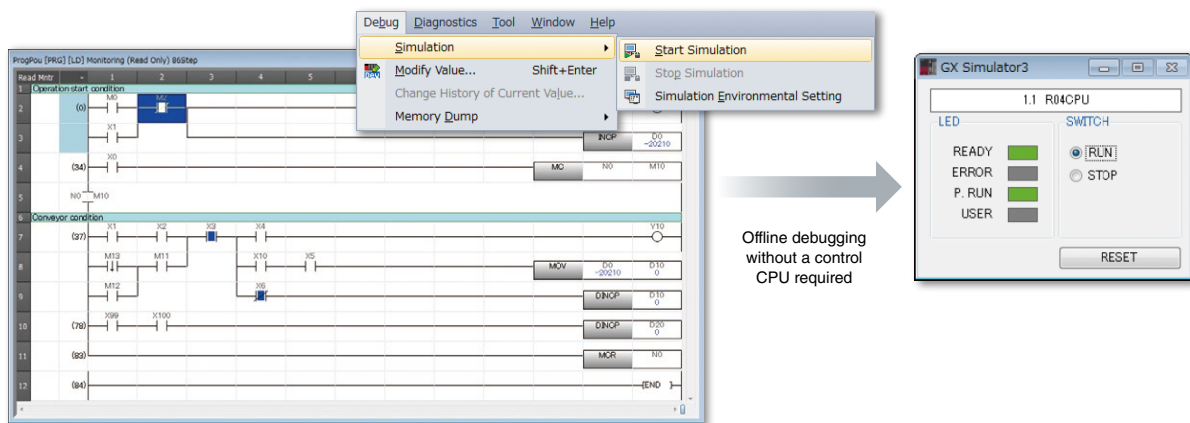

**Point 13**

**Quick search enables execution of functions quickly**



- Displays related functions from the entered key word
- Related functions can be searched easily, reducing time to search a manual

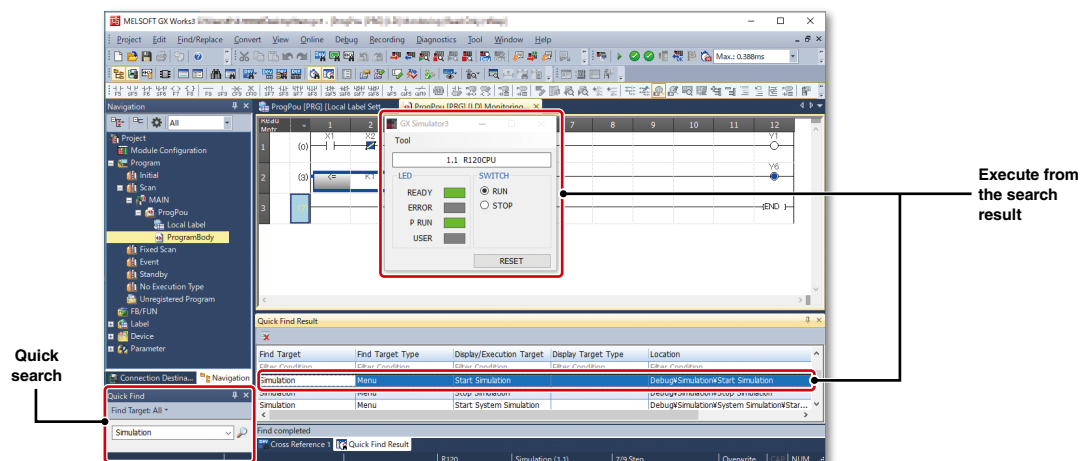

Point 14

Visualize device status and affected area of programs



- Data flow analysis visualizes the device status and affected area of programs
- When taking over and maintaining programs created by others, it is easy to understand the programs

Select device/label/instruction to be checked

Easy-to-understand flow diagram showing the relationship between devices, labels, and instruction establishment conditions

Comments, instruction names, event history, and monitored values are displayed

Point 15

AI analysis simplifies cause analysis by inferring the relationship between input and output devices that changes with equipment operation **NEW**



- AI-powered data flow analysis of logging data from normal operation infers and displays physical relationships of input/output devices that change as equipment operates, even if they are unrelated in the program
- It helps to analyze the root cause of stoppages caused by the operation of the equipment that do not trigger errors

1 Collect normal operation data      2 Data analysis by AI      3 Result of AI analysis

Log Collect logging data from normal equipment operation

MELSEC iQ-R Series      MELSEC iQ-F Series

GX Works3

Display the three most relevant results of AI analysis. Physical relationships can be checked here

Scope of AI analysis (unrelated in the program)

Scope of conventional function (related in the program)

Point 16

Errors can be easily checked by module and network diagnostics



- Errors can be easily identified by using the diagnostic function
- Module configuration of the system and error status are easily recognized with system-wide monitoring

System monitor

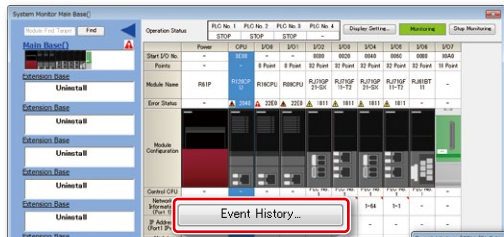

CC-Link IE Field diagnostics window

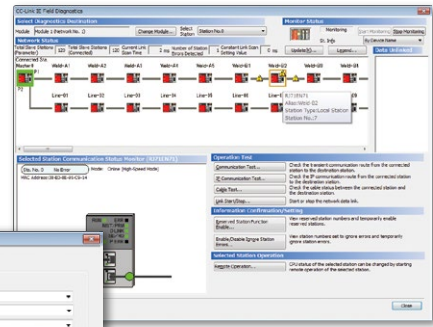

Event History (CPU (PLC No. 1) Start I/O No. 3630)

Retrieved: 1681 events

Refine: Match All the Conditions / Match Any One of the Conditions

No.	Occurrence Date	Event Type	Status	Event Code	Overview
00001	2014/06/09 16:24:21.651	System	Warning	020E0	Invalid module
00003	2014/06/06 14:26:58.827	System	Warning	020E0	Invalid module
00004	2014/06/06 14:25:56.798	System	Warning	01040	Prevention and reset
00005	2014/06/06 14:16:34.026	System	Warning	01000	Power shutoff
00006	2014/06/06 14:11:00.100	Operation	Information	24200	Creation of new folders, writes to file
00007	2014/06/06 14:04:58.417	Operation	Information	24300	Creation of new folders, writes to file

Detailed Information

System configuration information

Base No. 20(Main base)

Cause

- A module that the CPU module cannot recognize is mounted.
- Mount only applicable modules.
- The possible cause is a hardware failure of the I/O module or intelligent function module accessed. Please consult your local Mitsubishi representative.

Corrective Action

Detailed information including the cause and respective countermeasures are shown here

Point 17

Multi-language menu, ideal for global support

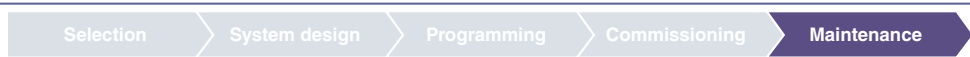

- GX Works3 supports multiple languages (Japanese, English, Chinese) for global use
- Device comments within the project can be switched between various languages
- When maintenance is performed by other language speakers, comments can be switched to their native language for smooth operation

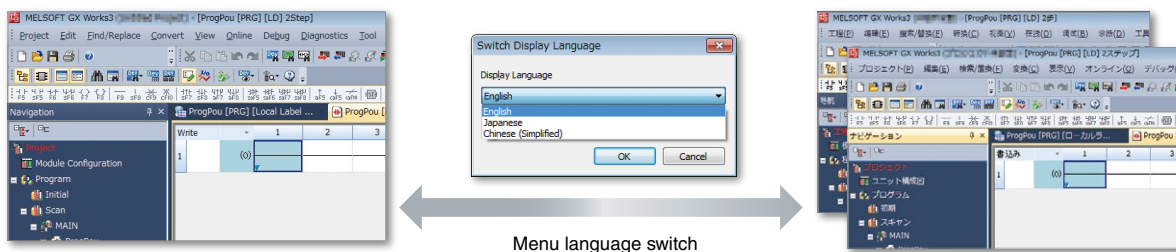

Menu language switch

Language version of comments being switched

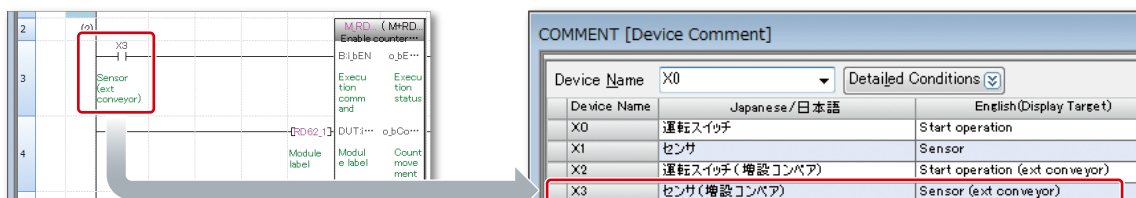

## Easy maintenance with data visualization

With GX LogViewer\*<sup>1</sup>, collected data and real-time data can be visualized on a computer without an oscilloscope.

\*1. For details on how to obtain the software, please contact your local Mitsubishi Electric sales office or representative.

Point  
18

### Analysis by visualizing device/label



- Identify a fault by overlaying logging data during normal operation and abnormal operation
- Monitor logging data in real-time by connecting with a programmable controller in operation

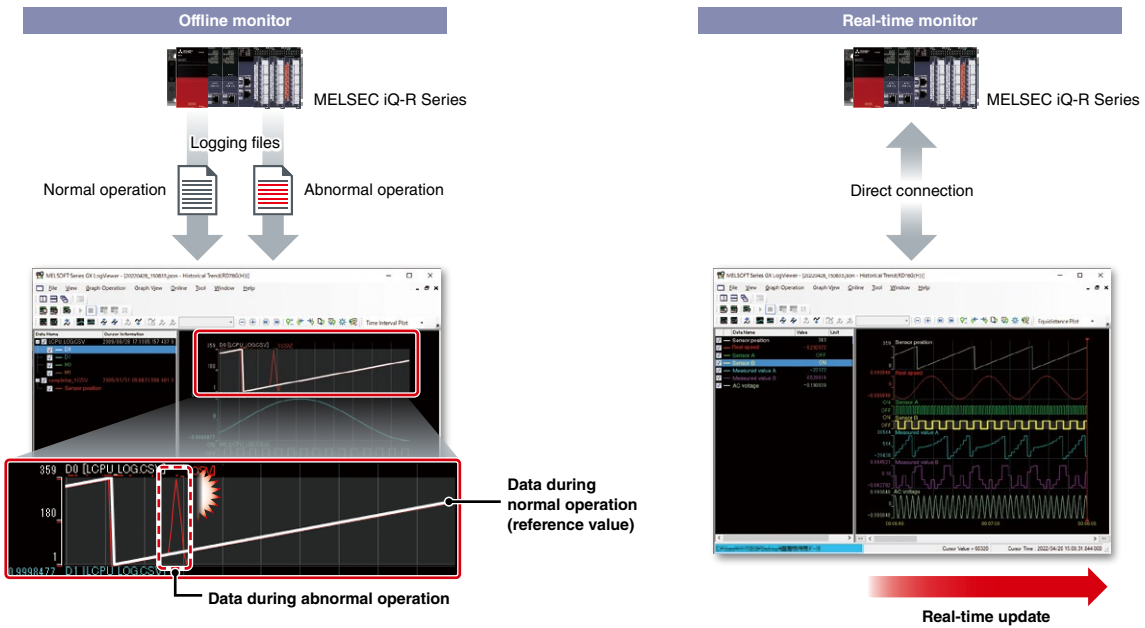

Point  
19

### Easier error analysis through synchronized playback of related data



- Synchronized playback of data can be viewed only by loading recorded operation data to GX Works3 and thus executing the tools necessary for viewing
- Playback of program transition on GX Works3 can be synchronized with GX LogViewer and GOT offline monitor, simply by moving the slider on the seek bar back and forth and thus facilitating the efficiency of error analysis

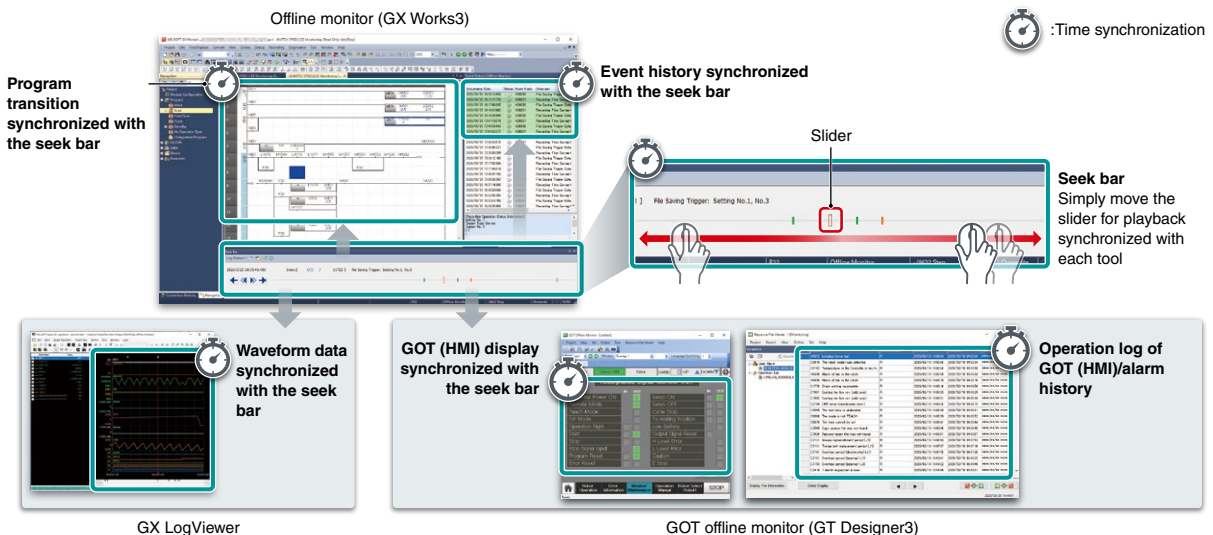



# Smart factory

## Customer's requirements

✓ Reduce wiring costs

Point 8

✓ Prevent system downtime by responding quickly to problems on the shop floor

Point 3   Point 6   Point 9   Point 10   Point 11   Point 12   Point 13

✓ Learn how to implement IIoT for equipment

Point 1   Point 2   Point 4   Point 5   Point 7



# Maximize productivity and reduce costs with an intelligent smart factory solution

Intelligent smart factories utilize high-speed networks with large data bandwidths to meet current manufacturing needs. The combination of CC-Link IE TSN and Mitsubishi Electric's e-F@ctory solution ensures robust integration between IT and factory automation systems, providing an intelligent smart factory solution that reduces total cost while improving operations, production yield, and efficient management of the supply chain. e-F@ctory is the Mitsubishi Electric solution for adding value across the manufacturing enterprise by enhancing productivity, thereby simultaneously reducing maintenance and operating costs, and enabling the seamless flow of information throughout the plant. e-F@ctory uses a combination of factory automation and IT technologies in combination with various best-in-class partner products through its alliance program.

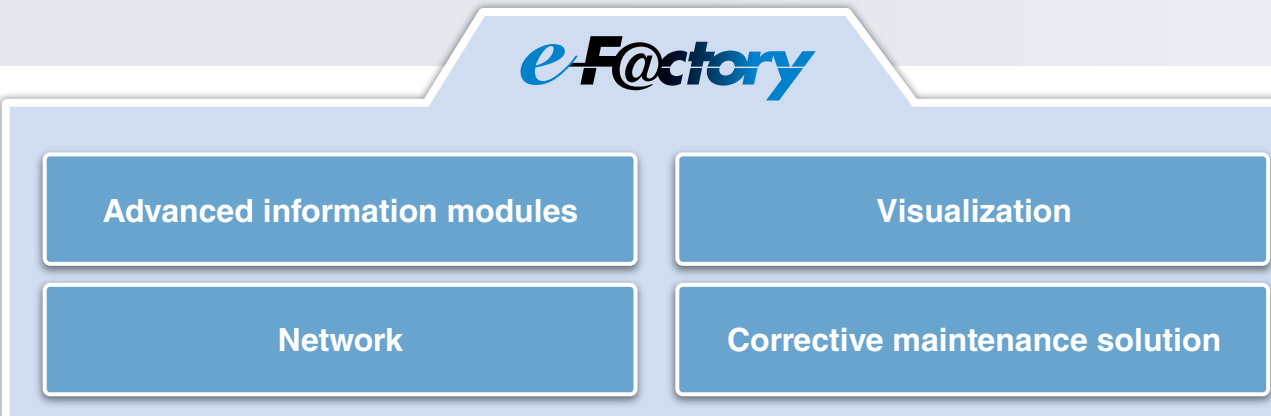
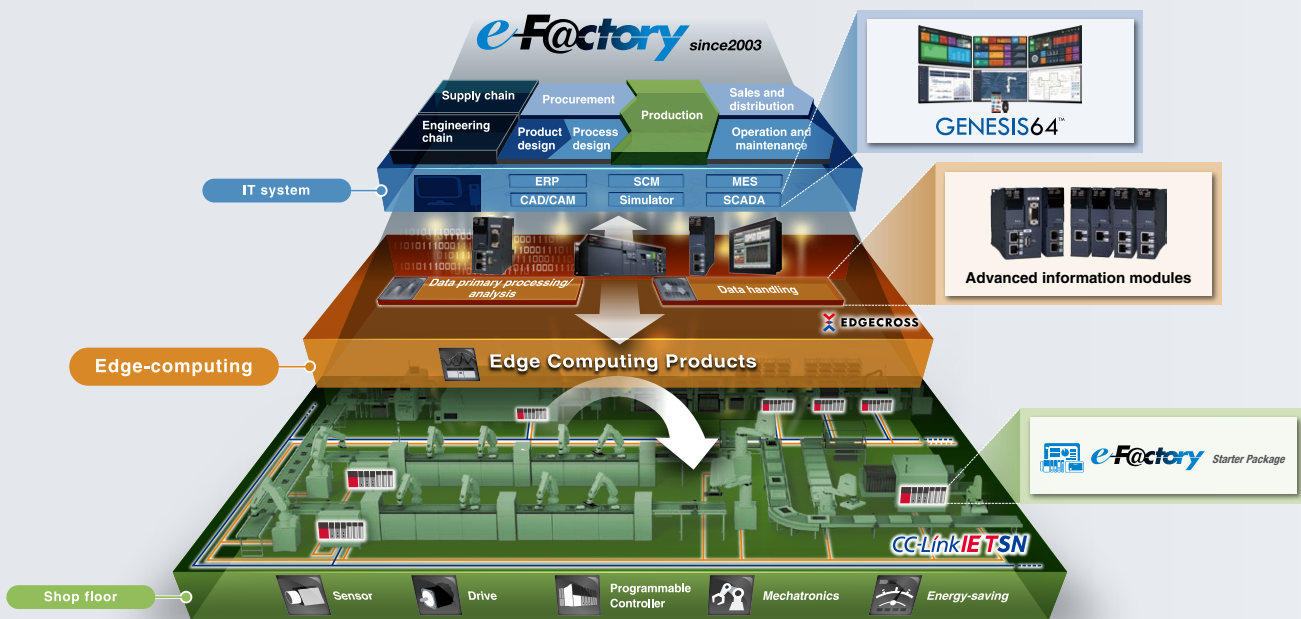

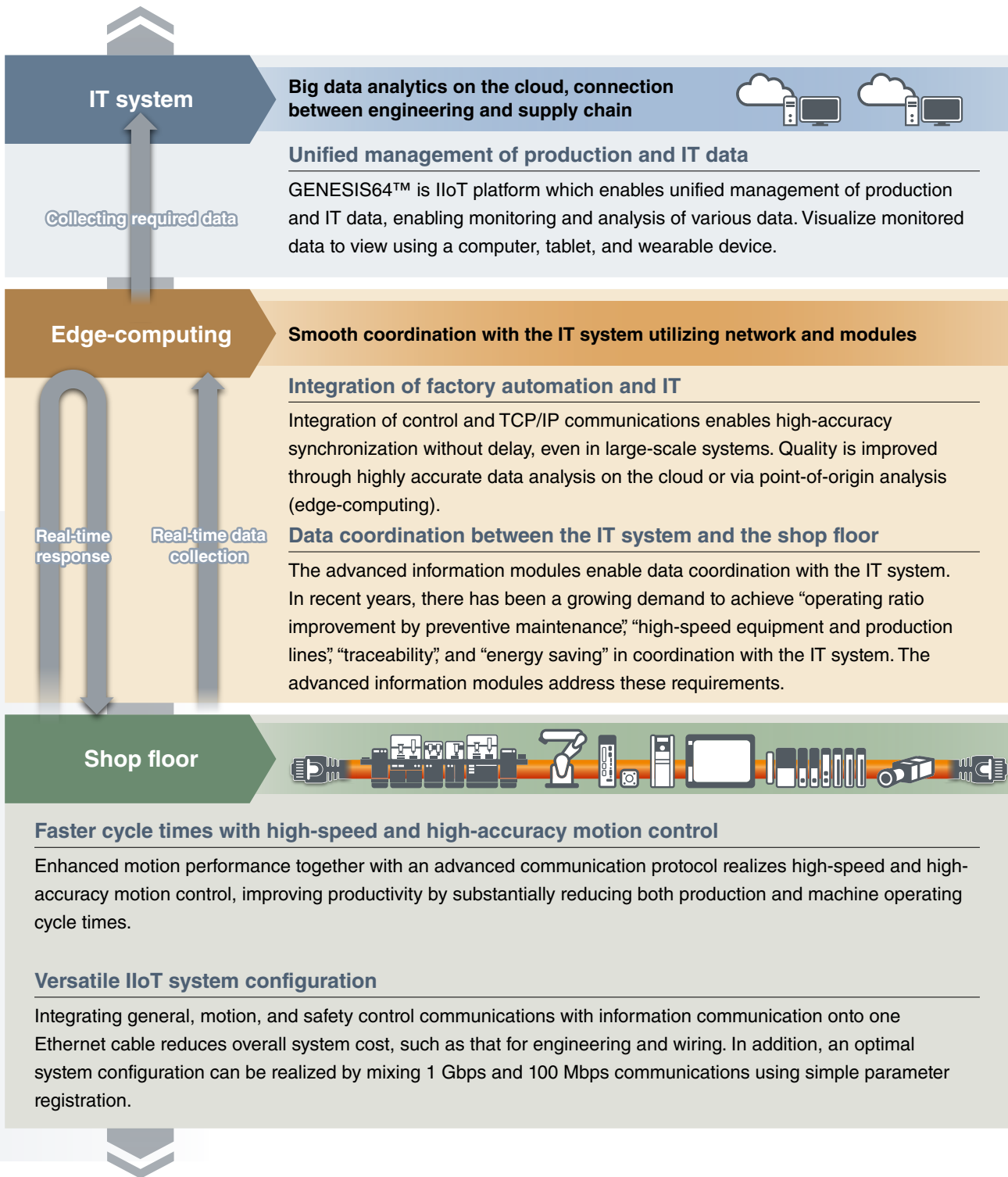

=



## IT system coordination utilizing advanced information modules

The MELSEC iQ-R Series advanced information modules enable smooth coordination between the IT system and the shop floor.

► For more information about the modules, please refer to page 130.

Point  
1

### Provide production instructions according to the situation in coordination with the SCADA system

- Utilizing the MES interface module or OPC UA server module enables handling of production data such as production instructions (e.g., recipe data) and production data (e.g., number of faulty products)
- Data collected from the shop floor is analyzed using SCADA software such as GENESIS64™, and production instructions based on that analysis can be provided to related systems
- Efficient production is possible with real-time data coordination of production instructions and production data

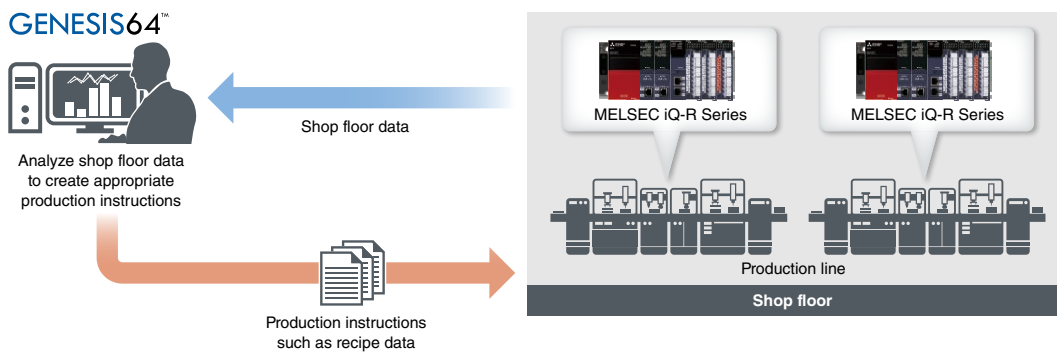

Point  
2

### Utilize production data collected at high speed for traceability

- Utilizing a high-speed data logger module, production data can be collected at 0.5 ms (max.) and easily checked as Excel®/CSV files
- Data for each process can be collected even if a problem occurs in any of the production processes, helping to identify an error cause in more detail

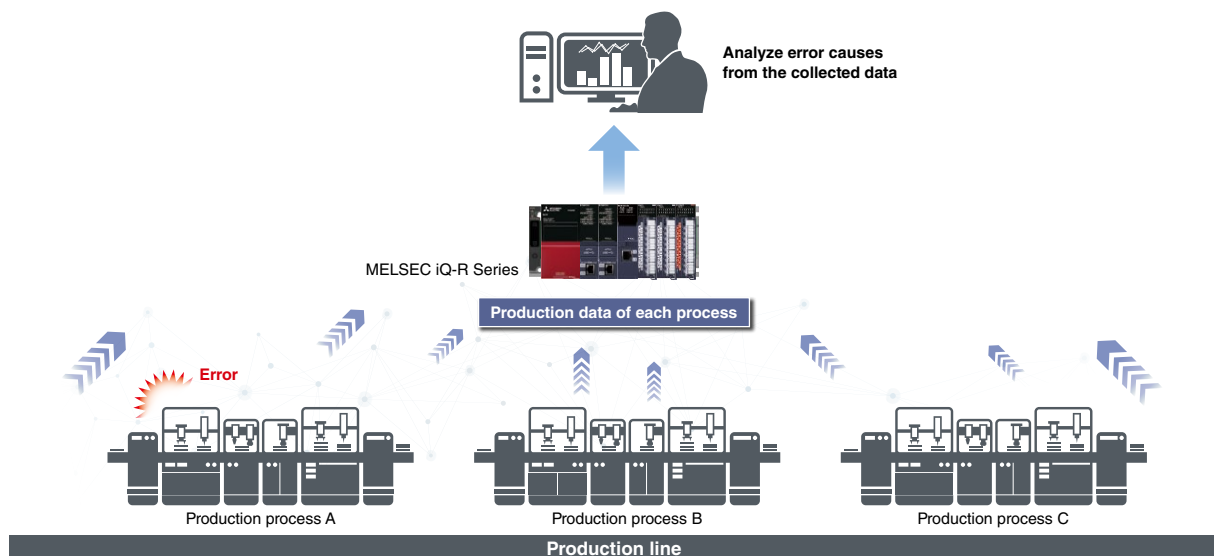

Point 3

Detect signs of failure in real-time from equipment operating data

- Utilizing the high-speed data communication module, signs of failure can be detected in real-time by receiving and analyzing equipment operating data
- Equipment can be maintained before it malfunctions, reducing system downtime and improving productivity

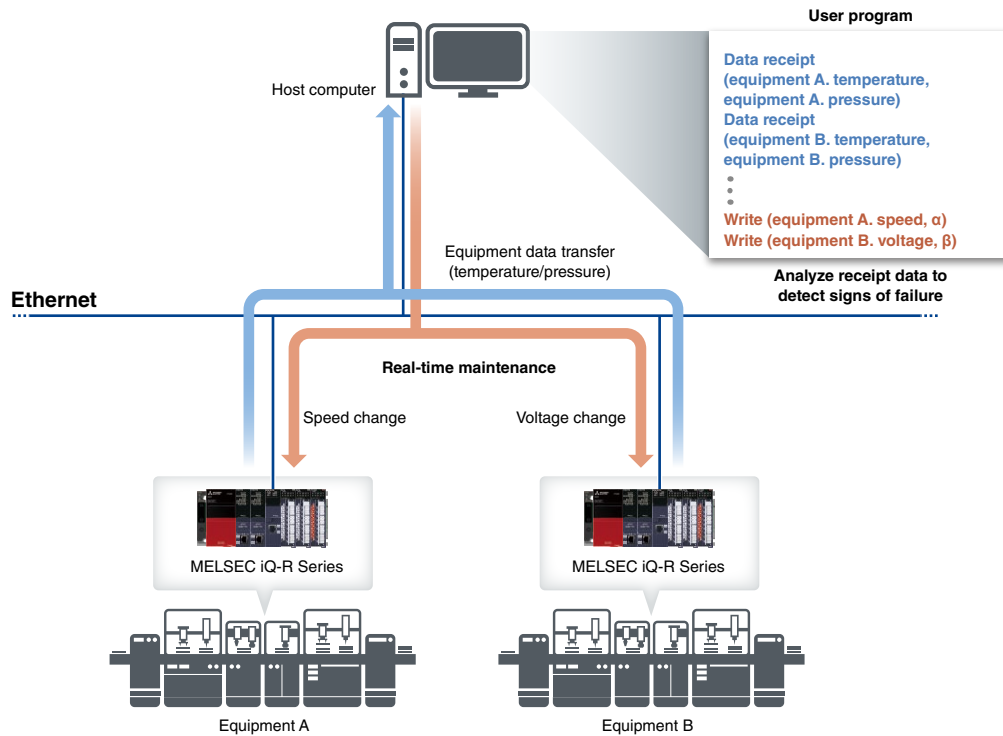

Simple IT coordination utilizing software

Utilizing data access software MX Component and MX Sheet can visualize the shop floor data.

Point 4

Visualize programmable controller data to utilize for reporting

- Automatically collect programmable controller device data to generate spreadsheet reports, reducing time to check and transcribe data
- Collected device data can be processed by Excel®, allowing easy andon system configuration

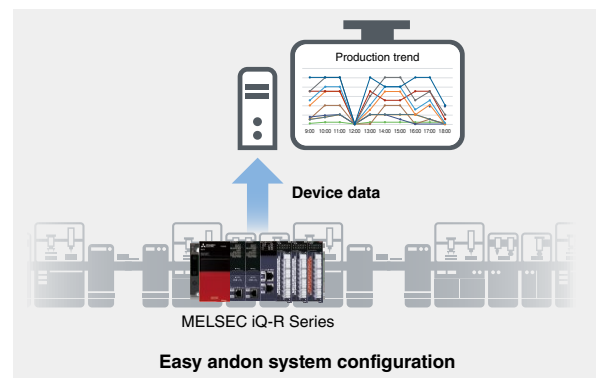
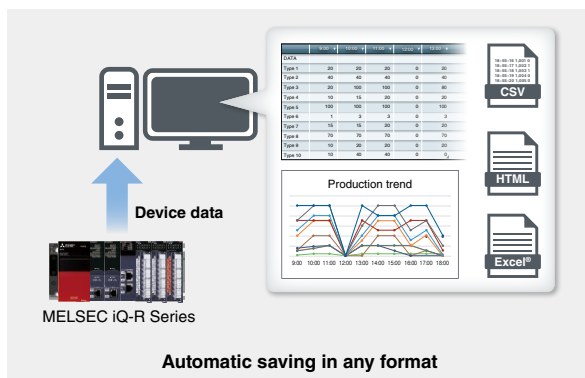

## Support IIoT on the shop floor with e-F@ctory starter package

The e-F@ctory starter package includes sample projects for the MELSEC iQ-R/iQ-F Series and the GOT2000 Series. Programs for visualization and simple analysis are provided in sample project format, supporting an IIoT infrastructure on the shop floor just with basic settings such as device assignment and parameter registration.

► For details on e-F@ctory starter package, please refer to the "e-F@ctory Starter Package broadcast (E001ENG)";

Point  
5

### Easily realize IIoT with extensive lineups for different purposes

■ Various functions for equipment management, maintenance, and improvement are available

#### Visualize overall equipment effectiveness

MELSEC iQ-R MELSEC iQ-F

Comprehensively displays the production and operational status of the equipment such as equipment overall effectiveness and number of production.\*1

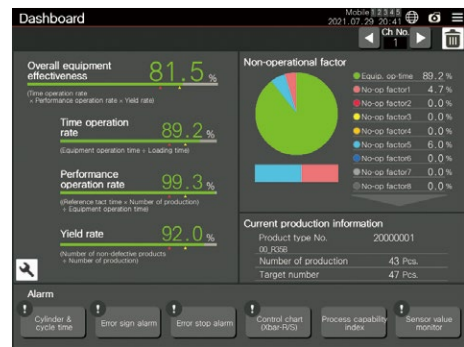

#### Error detection by measuring the cylinder operating cycle time

MELSEC iQ-R MELSEC iQ-F

Counts and monitors the cylinder operating status and the equipment operation cycle to monitor the error sign.\*1

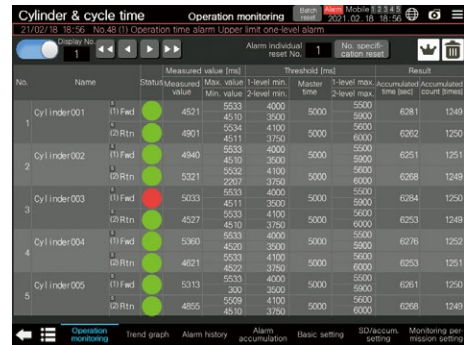

#### Easily acquire and visualize CO<sub>2</sub> emissions and other data

MELSEC iQ-R

CO<sub>2</sub> emissions, specific energy consumption, production volume, electric energy can be easily checked. Electric energy and production volume data are saved for energy loss analysis per production line and equipment process.

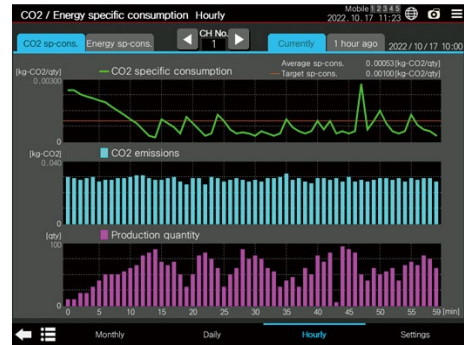

\*1. The screen is from the MELSEC iQ-R Series.

### Detect “difference from usual” with MT method

MELSEC iQ-R MELSEC iQ-F

Quantifies the deviation degree between the normal data and input data to detect an error. Includes a function inputting feature quantities calculated by time-series data collection and vibration analysis as input data.\*1

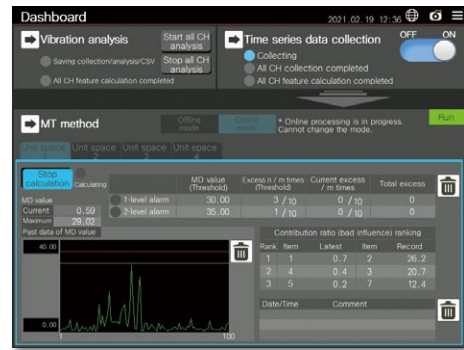

### Error detection by monitoring shape of analog waveform

MELSEC iQ-R

Monitors threshold according to waveform shape. Guard band monitoring enables wave monitoring of analog waveform data such as current and temperature. Abnormal waveform variation can be detected, which was difficult with simple threshold monitoring.



### Management of equipment and process change

MELSEC iQ-R

Change point management from perspectives of 4M\*2 and 5M\*3 + 1E\*4 used for quality control is realized, allowing root cause analysis when an error occurs.

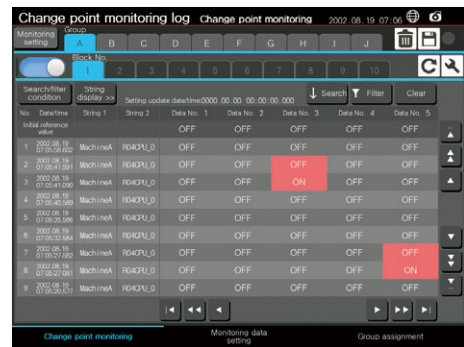

### Error detection by vibration waveform analysis using frequency analysis

MELSEC iQ-R

Quantifies vibration generated from facilities, equipment, and products by vibration analysis (FFT) to visualize the status. Detection of abnormal vibrations enables preventive maintenance of equipment, improving productivity.

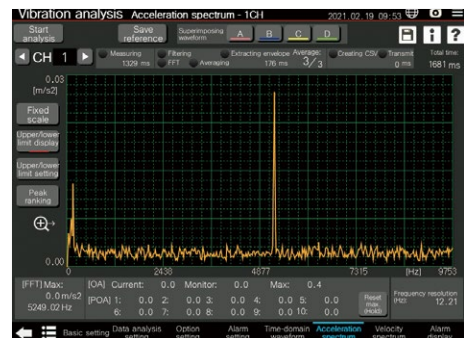

\*1. The screen is from the MELSEC iQ-R Series.

\*2. 4M: Man, Machine, Method, and Material

\*3. 5M: 4M + Measurement

\*4. 1E: Environment

## Visualization solution of production and IT data

SCADA software GENESIS64™ is IIoT platform which enables unified management of production and IT data, enabling monitoring and analysis of various data. This cutting-edge software delivers real-time visualization, mobility, analytics, and connectivity to deliver a contextualized view of enterprise operations for manufacturing, industrial automation, and smart buildings customers.

► For details on GENESIS64™, please refer to the "ICONICS Automation Software Suite catalog (L(NA)08785ENG)".

Point  
6

### Visualizing data for preventive maintenance

- Utilizing GENESIS64™, multi-site production monitoring is possible, helping to reduce facility operating costs
- Real-time monitoring enables efficient operation of equipment, resulting in high productivity
- Analysis results of monitored data can be fed back to the production line for utilization for preventive maintenance



SCADA software  
GENESIS64™  
concept

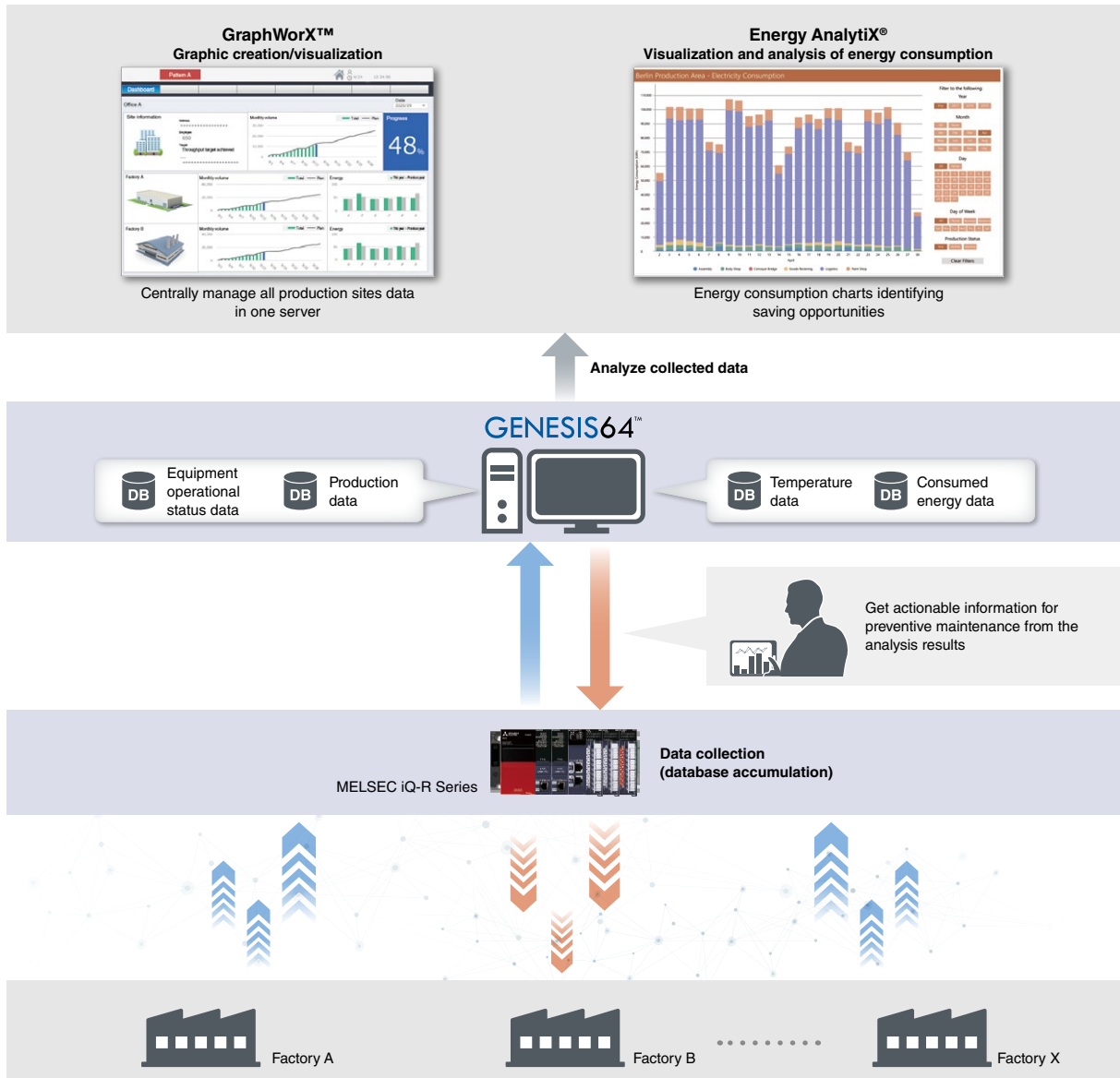



## Smooth coordination with various devices

Smooth coordination with devices is possible with simple CPU communication function which enables data communication between programmable controllers and CC-Link IE TSN which enables seamless general, safety and drive communication between the IT systems and the shop floor.

Point  
7

### Easy data coordination with third-party programmable controllers just by registering parameters

- The Ethernet interface module allows device data exchange by parameter registration with Mitsubishi Electric programmable controllers as well as third-party programmable controllers (simple CPU communication function)\*1
- Data collection is easier without changing programs of the existing programmable controllers

\*1. For the list of connectable devices, please see the link below.  
[www.MitsubishiElectric.com/fa/ref/ref.html?k=plcr&pmerit=simple\\_cpu\\_com](http://www.MitsubishiElectric.com/fa/ref/ref.html?k=plcr&pmerit=simple_cpu_com)

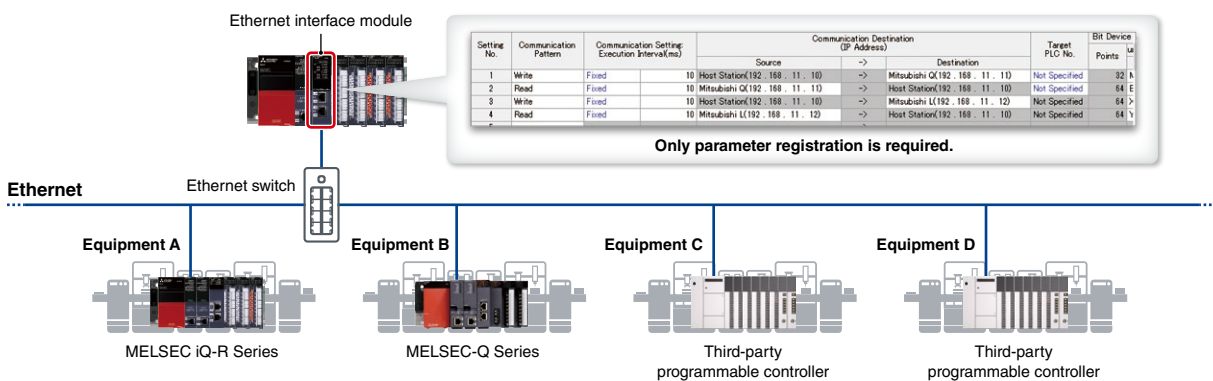

Point  
8

### CC-Link IE TSN seamlessly connects the IT system and the shop floor on one network

- CC-Link IE TSN can integrate general, safety, and drive communications into one network, enabling flexible system configuration
- Various data from different processes can be transferred to the main controller and IT system utilizing edge-computing devices such as MELIPC, realizing easy data coordination
- The CC-Link IE TSN Plus master/local module supports EtherNet/IP™ devices while maintaining the high-speed/high-accuracy communications of CC-Link IE TSN

▶ For details on CC-Link IE TSN, please refer to the "CC-Link IE TSN Product Catalog (L(NA)08656ENG)";

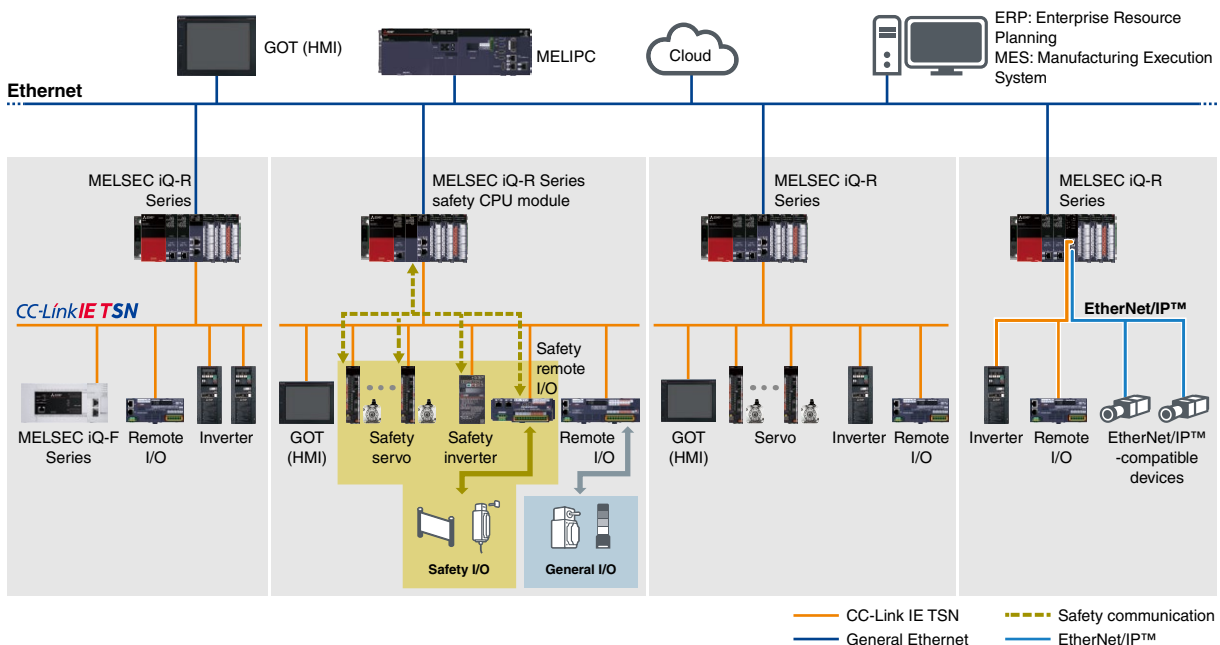

## Corrective maintenance solution with system recorder

Maintenance is critical for ensuring continuous production. Maintenance includes ① **predictive maintenance** to detect signs of error, periodical ② **preventive maintenance**, and ③ **corrective maintenance** for prompt troubleshooting at the time of failure. Mitsubishi Electric proposes an enhanced maintenance solution by recording and sampling production and machine operating data and utilizing this data within various stages of maintenance. The system recorder is a ③ **corrective maintenance** solution that ensures prompt troubleshooting and error prevention.

**Total maintenance solution**

Device Equipment Line X Predictive Preventive Corrective

Simplifying maintenance across the plant

**Total maintenance = Extensive data management**

- **Data collection** from various equipment and devices on the shop floor
- **Systematic data analysis** irrespective of personnel skill level

### System-wide recording and simplified analysis

#### System-wide recording

■ **Extensive recording ensures simpler cause analysis**

Error cause identification is made simpler by the extensive recording of various equipment and device data together with a real-time video feed reducing the need for multiple retesting due to insufficient data.

■ **System-wide recording**

Irregularities between various equipment including control and drive systems together with operations are all linked.

■ **Automatic system-wide recording**

Recording of errors that can occur outside standard operating shifts.

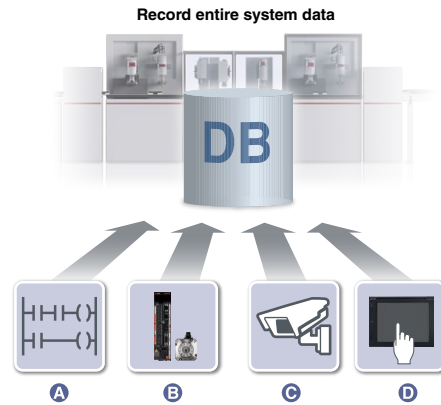

- A All device/label/event history
- B Servo system data (position/speed/torque)
- C Network camera video feed
- D Operation log of GOT (HMI)/alarm history

#### Simplified analysis

■ **Extensive data shown in the same timeline**

Waveform, data, program, operations log, and video feeds are shown in sequence ready for analysis.

■ **Easier cause identification**

Data flow analysis makes understanding the root-cause of failures easier by showing the relationship between failed and normal devices.

■ **Structured program ensures easier troubleshooting**

Supports structured programs and device labels enabling easier resolution of problems, thereby reducing TCO\*1.

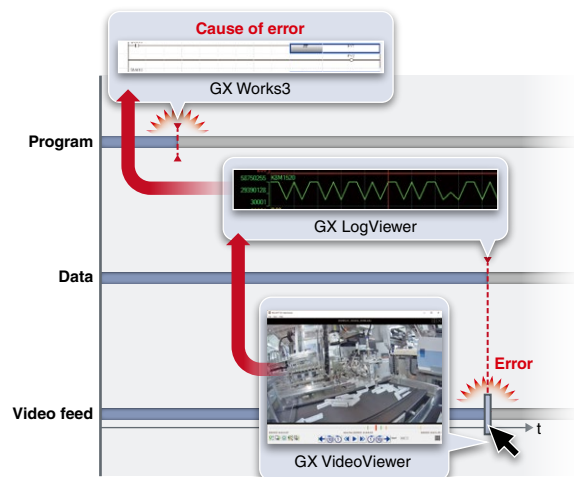

\*1. TCO: Total Cost of Ownership

► For details on solution, please refer to the "System Recorder Catalog (L(NA)08736ENG)".

Point 9

Extensive collection of error related data

- Prompt error cause identification is important to minimize the equipment downtime
- As all device and label data related to errors can be collected, there is no worry about selecting recording targets

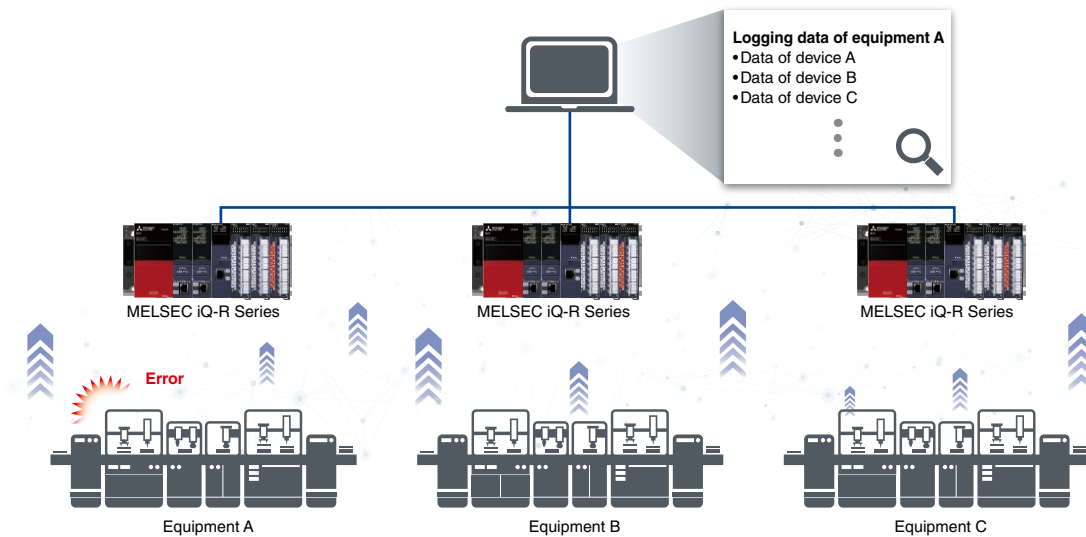

Point 10

Recording-compatible devices\*<sup>1</sup> record the entire data synchronously, enabling easier error-cause identification

- When any of the compatible modules detects an error, all data recorded in the system is saved at the same time
- Even for the large-scale system, errors can be notified to other stations via CC-Link IE TSN
- By comparing the control data for each device and video feeds when an error occurs, the error cause within multiple devices can be easily analyzed

\*1. The recorder module, camera recorder module, motion CPU module, and motion module are supported.

Example of a packaging machine

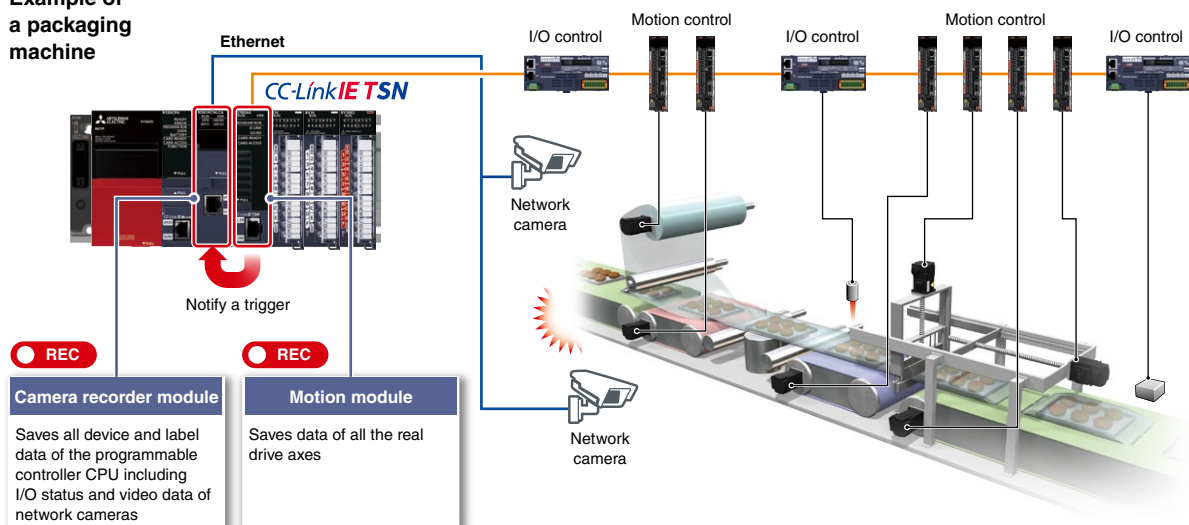

**Point 11**

**Record the moment when an error occurs**

- Network camera image recording allows identification of the moment an error occurs
- By supporting available network cameras offers a broad choice of functions that maybe specific to an application and installation environment

**Wide angle/fish-eye lens type:**  
Enables panoramic view of an entire production line

**Optical zoom type:**  
Provides detailed and vivid images

**PTZ (Pan-Tilt-Zoom) type:**  
Pre-registered positions allowing multiple areas with a single camera

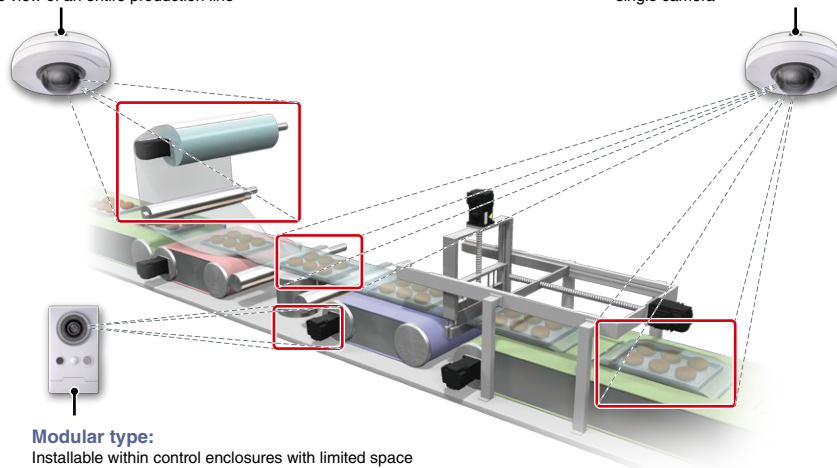

**Modular type:**  
Installable within control enclosures with limited space

**Wireless type:**  
Greater installation flexibility as communication cables are not required

**Point 12**

**Quickly identify an error cause**

- Device/label data related to an error and programs used can be checked on one screen
  - ① Device and labels together with the affected area can be visualized within the flowchart
  - ② Areas of concern in the program can be bookmarked for later check
  - ③ Monitored values and programs can be checked easily

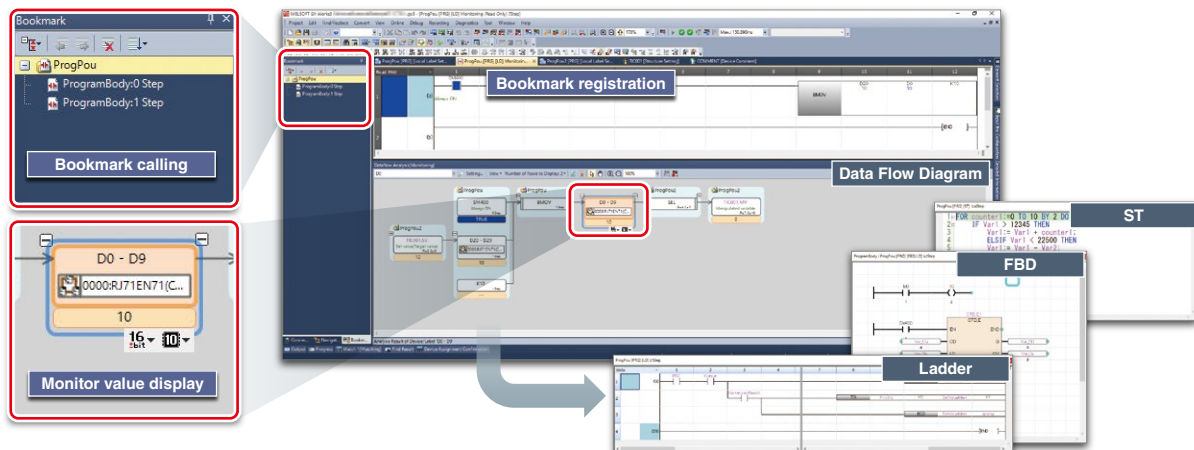

Point 13

Easily analyze recorded video feeds

■ Analysis is easy by adding milestone points (log marker) to the main video timeline enabling reference points for area of concern and synchronizing these points between GX Works3 (circuit monitor) and GX LogViewer (waveform display)

- ① Milestone points (log marker) can be added to the moment when an error occurs
  - ▶ Share log markers among concerned personnel
- ② Log markers can be classified for easier identification
  - ▶ Color-coding, commenting

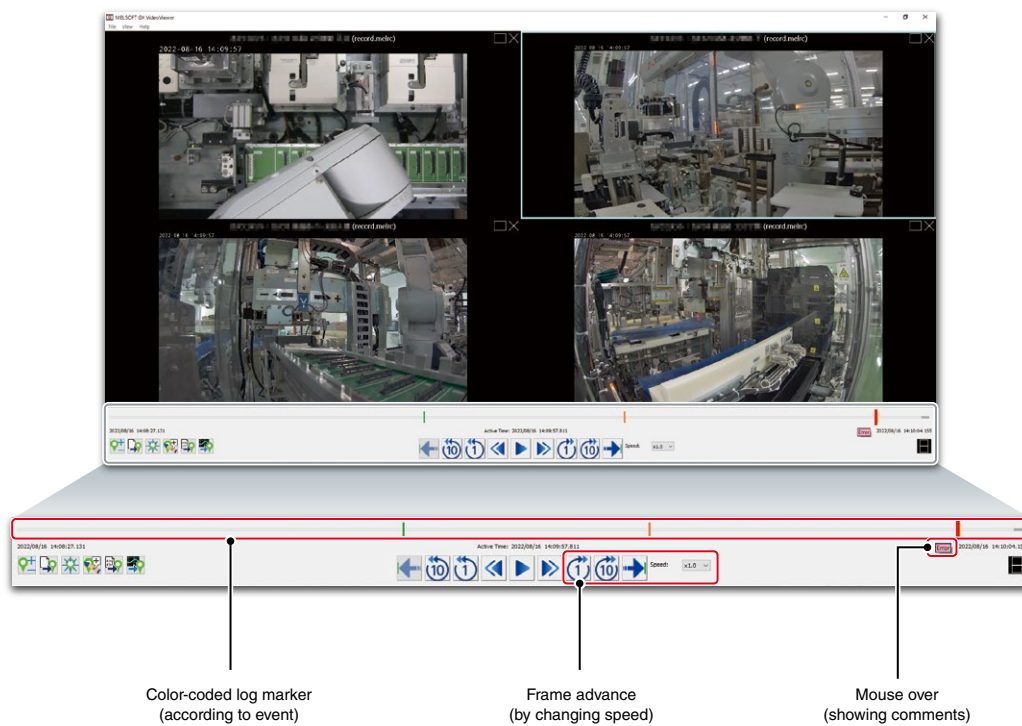

# Enhance factory safety

## Customer's requirements

✓ Ensure safety regardless of operator's skills or knowledge levels

Point 1

✓ Ensure operator safety without compromising productivity

Point 2

Point 3

Point 4



## Need for machine safety

Workplace safety has relied on safety training. However, safety devices are increasingly required to assure operator safety independent of human intervention.

### Safety from human intervention

#### Issue 1

Operator's inattention and work errors directly lead to accidents.

#### Issue 2

Workplace safety depends on veteran operators and ensuring safety is difficult due to generational changes.

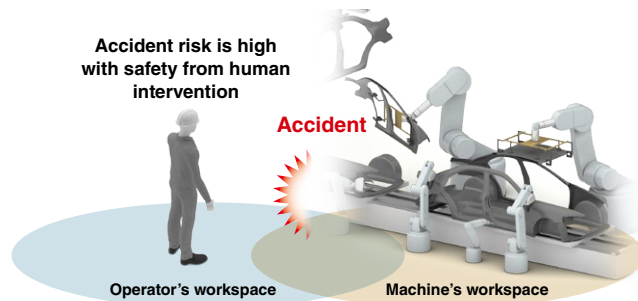

## Safety devices assure safety independent of human intervention

### Point 1

Ensure operator safety by separating an operator and a machine with safety devices

### Food processing machine

If a mixer starts running when an operator puts one's hand in to check the product or remove a foreign object, the operator can get caught in the mixer.

- A safety guard separates the operator from the mixer to ensure operator safety
- By combining the MELSEC-WS Series safety controller with a door lock switch and safety guard, an interlock can be created so that the mixer will not run while the safety guard is open, preventing the operator from accidentally getting one's hand caught in the mixer

► For details on the MELSEC-WS Series, please refer to the "Safety Programmable Controller/Safety Controller catalog (L(NA)08192E)".

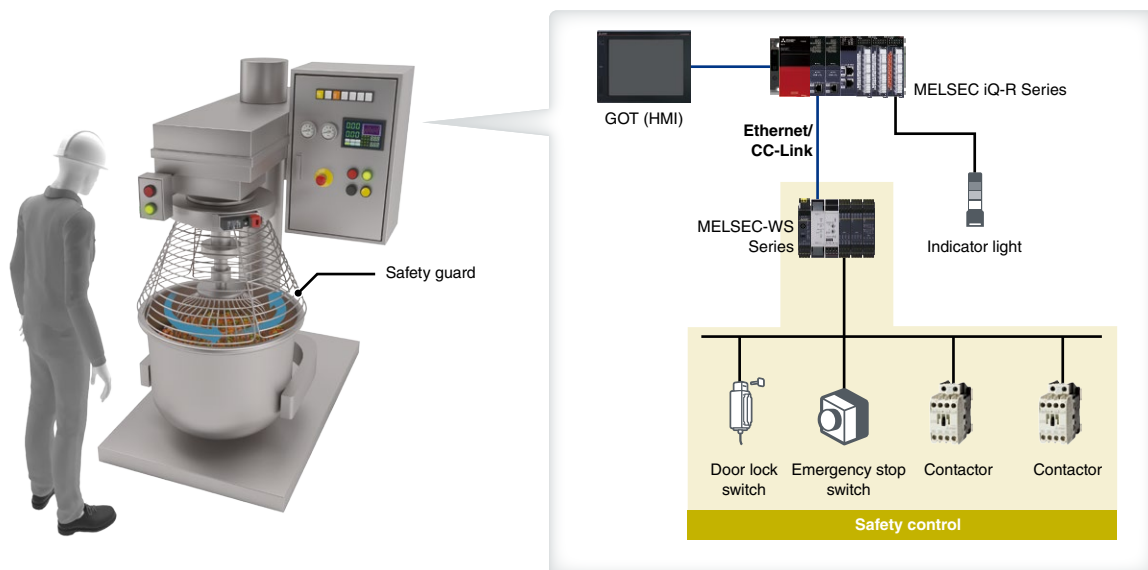

**Point 2**

**Coordination between servos, inverters, and robots enhance safety and productivity**

- Connecting safety drives such as servos, inverters, and robots with the MELSEC iQ-R Series safety CPU modules, various functions complying with the international safety standard such as STO (Safe Torque Off) and SLS (Safely-Limited Speed) can be used
- STO (Safe Torque Off) ensures safety of an operator without shutting off driving energy using a device (such as contactor) outside the drive, reducing time to recover

► For details on safety standards and functions, please refer to the "Safety Programmable Controller/Safety Controller catalog (L(NA)08192E)";

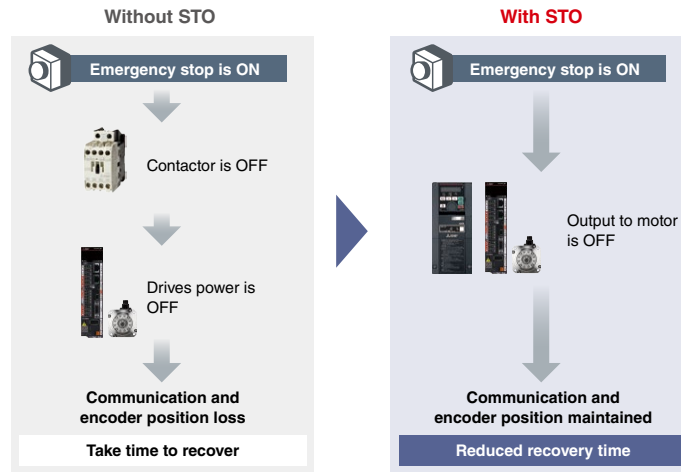

**Point 3**

**Shorter safety response time reduces installation space**

- The I/O combined remote module with safety functions can quickly shut off safety output without going through the safety CPU module (fast logic function)
- Since safety response time can be substantially reduced, distance between the emergency stop switch and hazard source can be shortened, reducing installation space

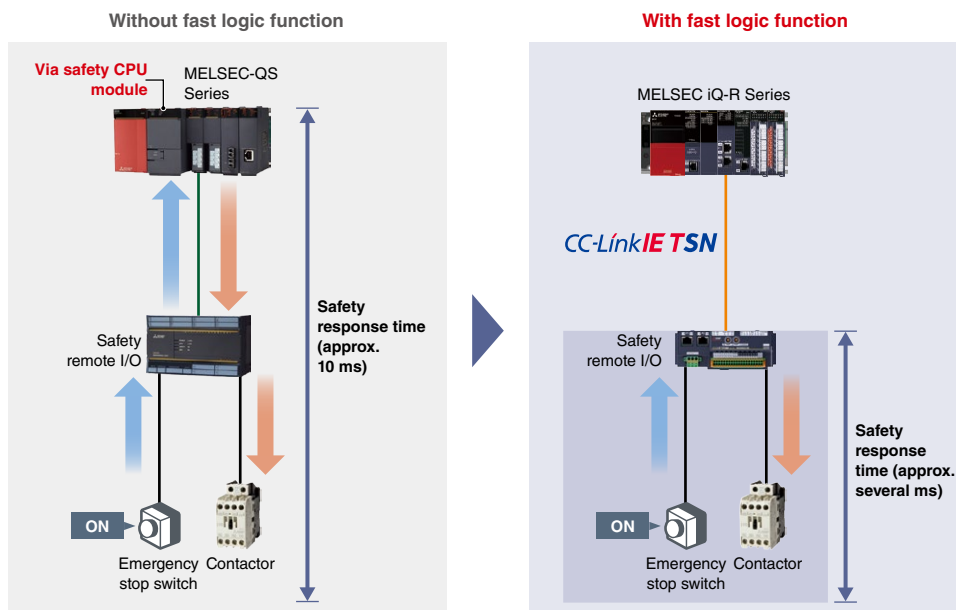



Point 4

Ensure safety without compromising productivity even in the large-scale system

- Integrating the MELSEC iQ-R Series safety CPU module and safety drives into CC-Link IE TSN ensures safety on a large-scale system such as an automotive assembly line
- If a hazard occurs in the process 1 and a machine is stopped, a machine in the process 2 temporarily stops. However, in the subsequent processes, production will continue without stopping
- Emergency stop of the machine can be enabled per process, avoiding the entire system shutdown and ensuring both safety and productivity

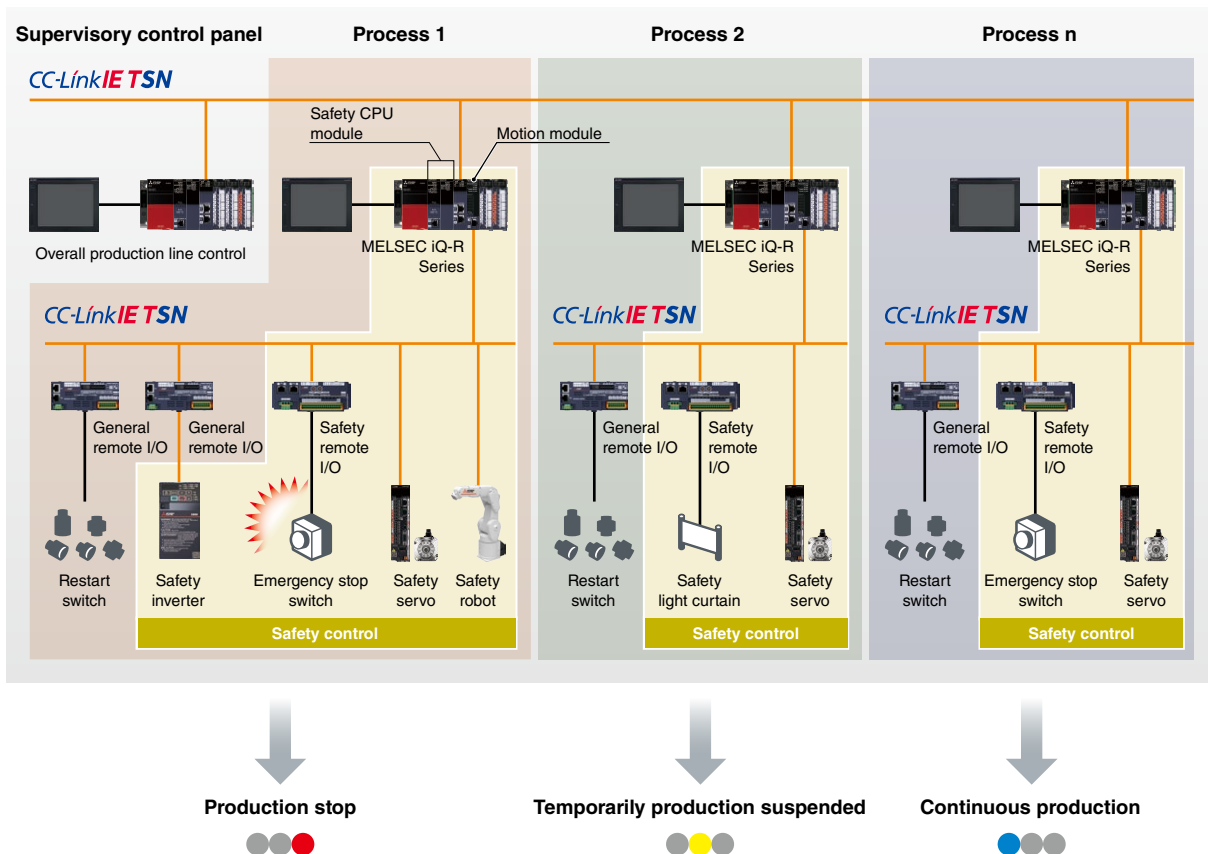
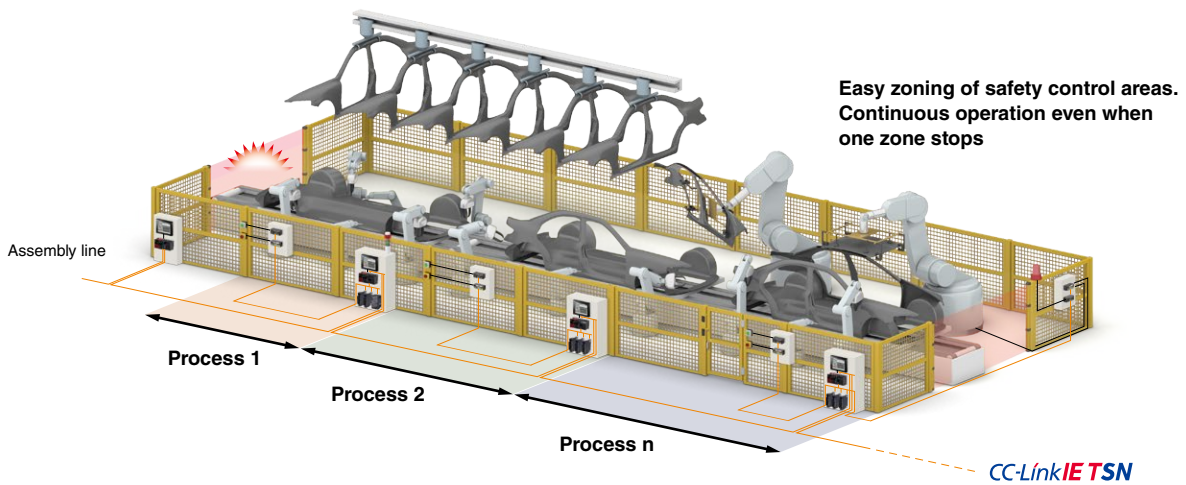

# Improve reliability of factories and infrastructure systems

Customer's requirements

✓ Prevent sudden system shutdowns and improve product and service quality such as steel, water treatment, chemical, food, HVAC, and other industries that require process control



**Point 1** Realize a highly reliable control system

- In the redundant system, continuous operation is ensured by automatically switching to the standby system when a hardware or network error occurs in the control system, realizing a highly reliable control system with general purpose programmable controllers
- The risk of single-point failure can be minimized by installing dual control systems consisting with redundant main base units with a power supply module, CPU module, and network module; redundant tracking cable, extension cable, and network cable; and dual head modules of remote stations
- In the event of an error in cables, local I/O stations, and remote I/O stations, online replacement is possible without stopping the CPU module operation

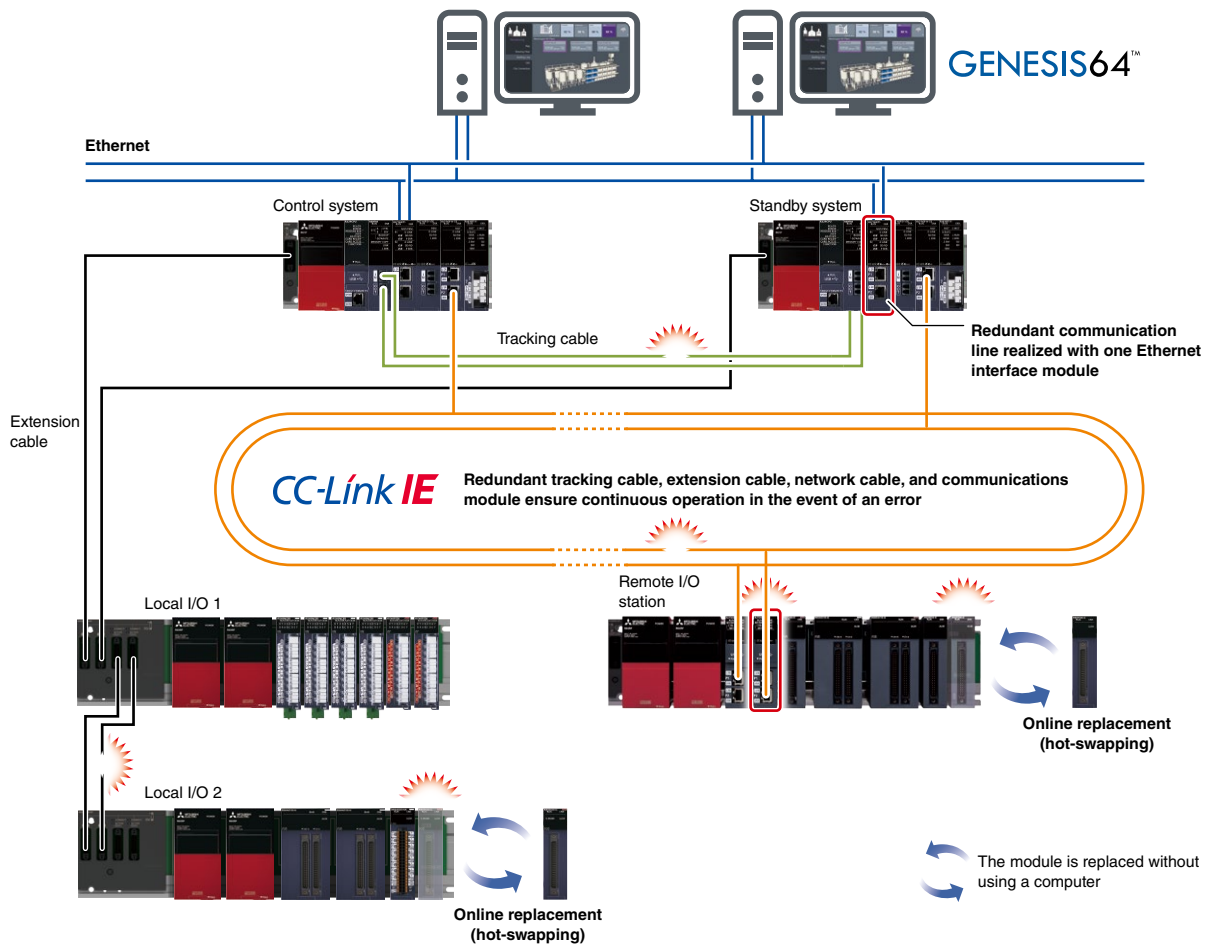

**Point 2**

**Configure process control system with easy programming**

- Engineering software GX Works3 provides an intuitive programming environment where process control programs can be easily created by connecting function blocks such as Tag FBs for process control on the screen by drag & drop operation
- Tag FBs for process control enable monitoring on the faceplate, trend display on the PX Developer monitoring tool, and parameter setting utilizing auto-tuning, thus making adjustment of the system startup easier
- Ladder, function block diagram (process control programming), sequential function chart, and structured text are supported

**Easy programming with process control FBs**

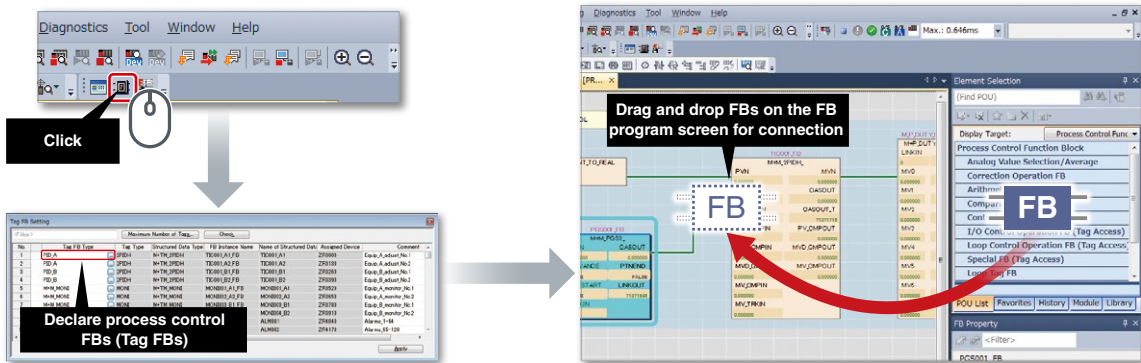

**Monitoring and tuning of process control FBs**

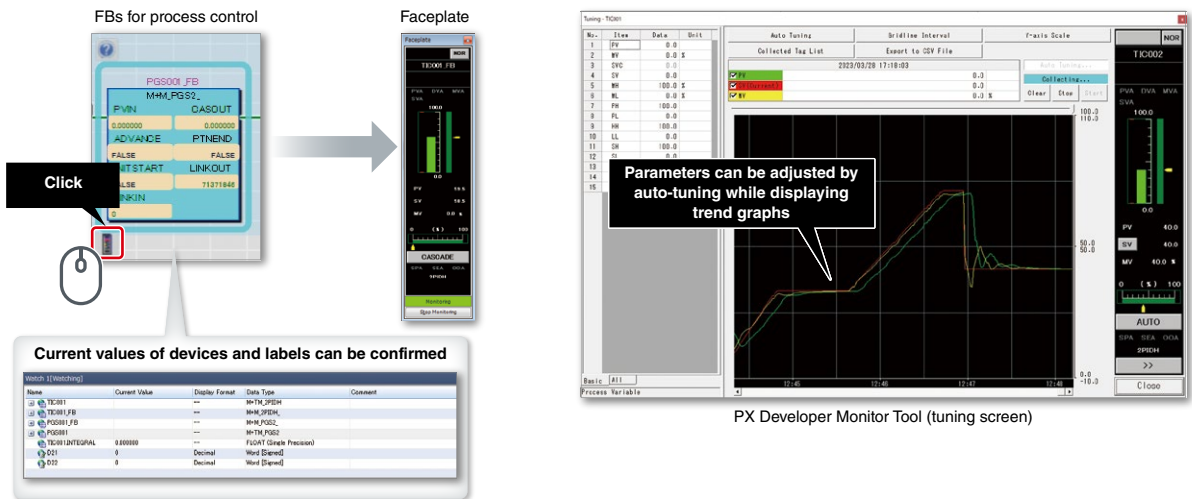

**Point 3**

**Configure a highly reliable system with CPU modules optimized for process control**

- The process CPU module and SIL2 process CPU module are equipped with the ECC (error correction) function in device/label memory, enabling 1-bit error correction on memory
- Continuous production is assured in the industries such as food, beverage, chemical, and infrastructure where product quality is greatly affected by data errors



Point 4

Configure a highly reliable system which can supply energy stably and efficiently

- Energy supply and usage such as electricity and gas in factories, buildings, and data centers can be monitored with the SCADA software GENESIS64™ in combination with a redundant system
- GENESIS64™ visualizes energy consumption, helping to estimate the efficient energy supply
- A redundant system ensures continuous operation of the infrastructure by switching the system in the event of an error

Data center implemented with GENESIS64™ and a redundant system

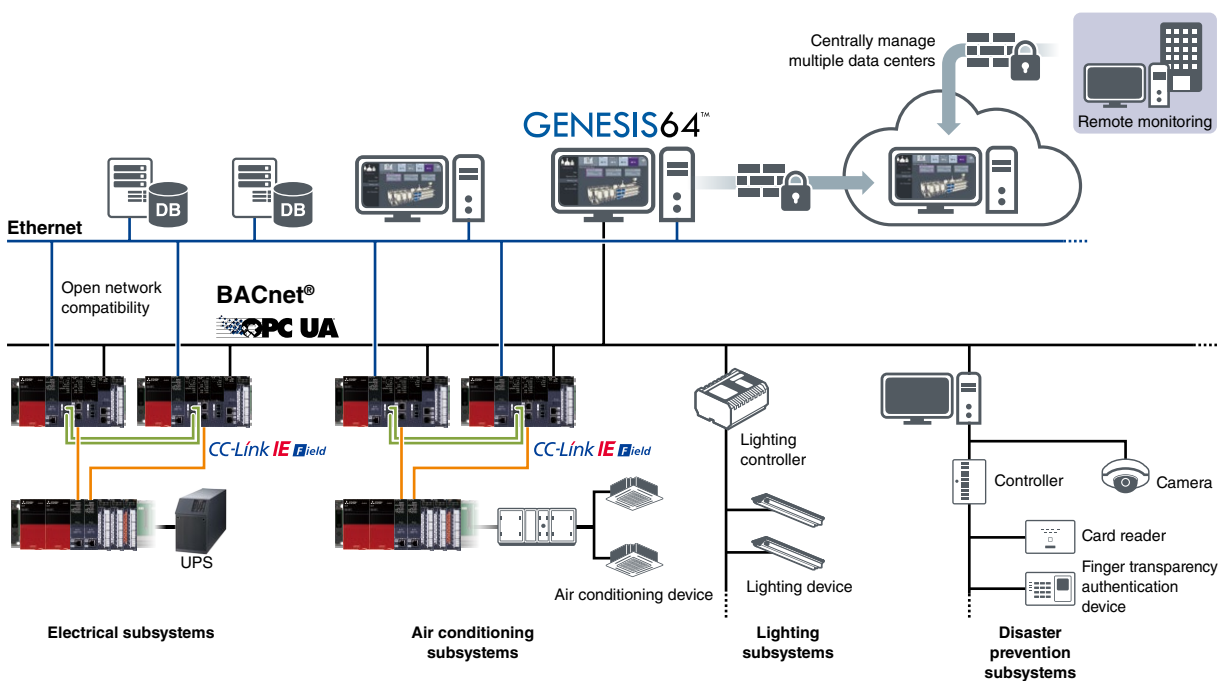
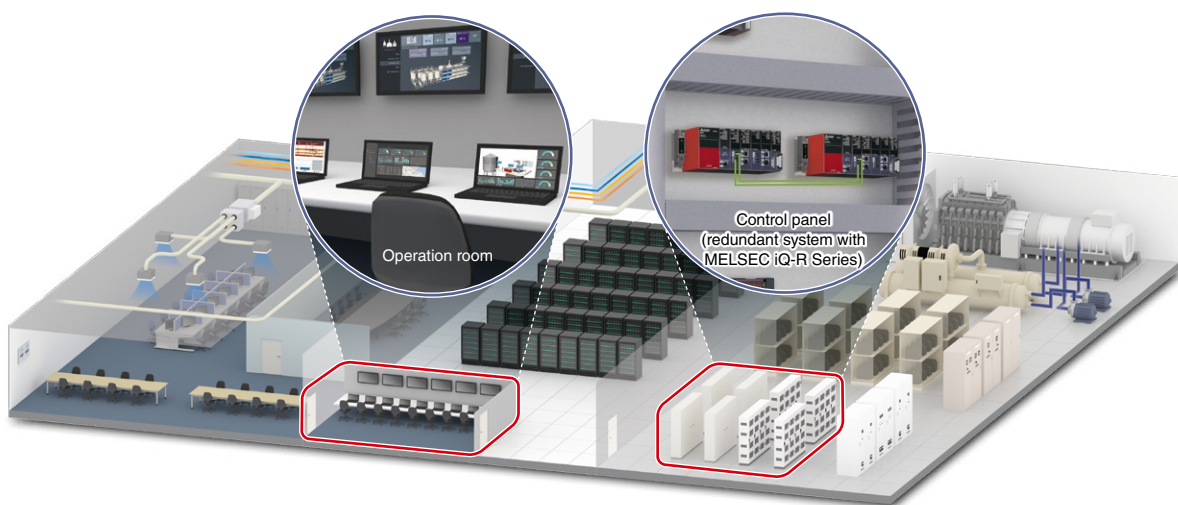

# For customers using the MELSEC-A/Q Series

## Utilization of existing assets

Point  
**1**

Automatic program conversion using Mitsubishi Electric's engineering software

The MELSEC-A/Q Series programs (projects, parameters) created with GX Works2 can be converted\*1 to the MELSEC iQ-R Series programs (projects, parameters) by simply opening them on GX Works3

\*1. Some data cannot be converted. For details, please refer to "GX Works3 Operating Manual (SH-081215ENG)."

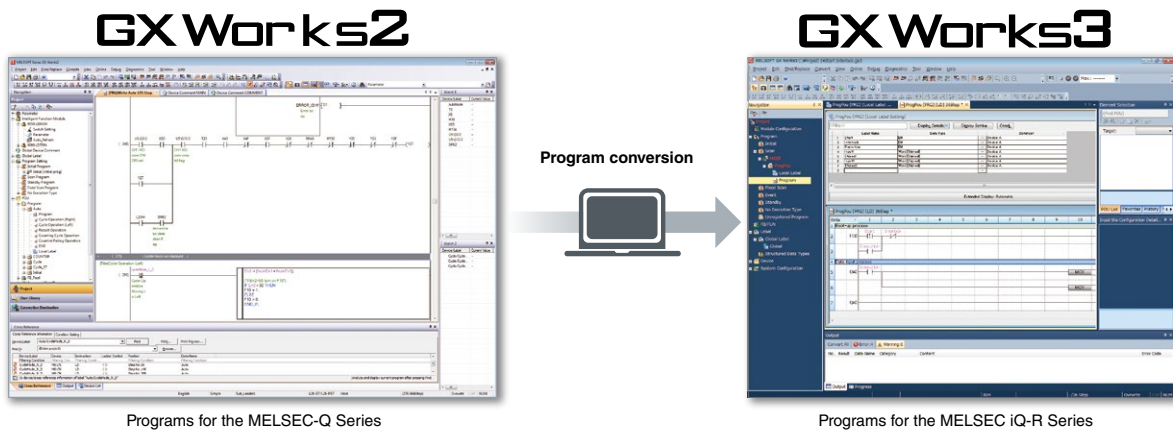

Point  
**2**

Existing MELSEC-Q Series modules can be used

Utilizing the RQ extension base unit, the MELSEC iQ-R Series modules can be added to the system where the MELSEC-Q Series modules are already used

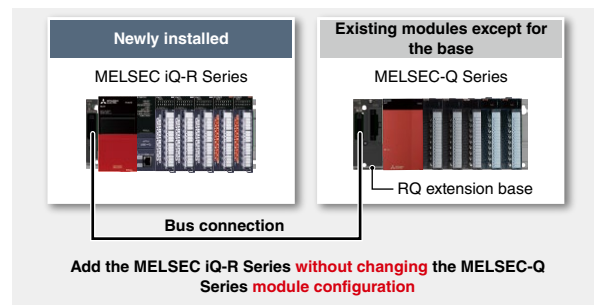

Point  
**3**

Existing wiring can be used

Terminal blocks and connectors of the MELSEC-Q Series I/O modules, analog modules, and high-speed counter module can be attached to the MELSEC iQ-R Series modules, allowing utilization of the existing wiring



## Support tools & guides for migration to the MELSEC iQ-R Series

### For model selection

#### 1 FA Integrated Selection Tool\*1

Select the existing MELSEC-Q Series modules and click the Migrate button. The MELSEC iQ-R Series replacement modules will appear.

\*1. Free tool available on the Mitsubishi Electric factory automation global site.



FA Integrated Selection Tool

#### 2 Migration tools\*2

Modules replacing the existing programmable controllers can be selected from the recommended MELSEC iQ-R Series modules.

\*2. Free tools available on the Mitsubishi Electric factory automation global site.

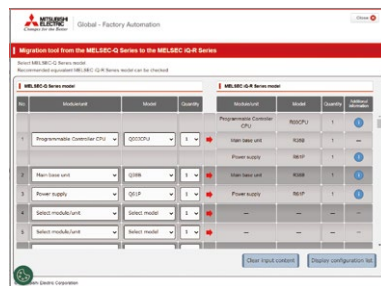

Migration tool from the MELSEC-Q Series to the MELSEC iQ-R Series



Migration tool from the MELSEC-A/QnA Series to the MELSEC iQ-R Series



Migration tool from the MELSEC-AnS/QnAS Series to the MELSEC iQ-R Series

#### 3 Product transition selection tool for programmable controllers

Replacement models using Mitsubishi Electric Engineering's devices can be easily selected.

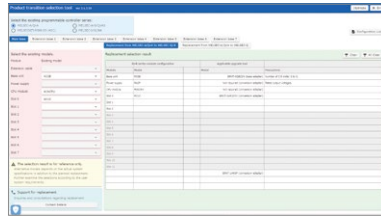

Product transition selection tool for programmable controllers

### For model replacement

These documents introduce modules to select in migration/transition from the MELSEC-A/Q Series to the MELSEC iQ-R Series.

- MELSEC-Q Series to MELSEC iQ-R Series Migration Guide (L(NA)08510ENG)
- Transition from MELSEC-A/QnA (Large Type) Series to MELSEC iQ-R Series Handbook (L(NA)08666ENG)
- Transition from MELSEC-AnS/QnAS (Small Type) Series to MELSEC iQ-R Series Handbook (L(NA)08668ENG)



# Basic system configuration

**C CPU module**

- Wide range of modules catering to all control needs
- The core of the programmable controller system

**D I/O module**

- Easily add appropriate modules from diversified lineups according to applications

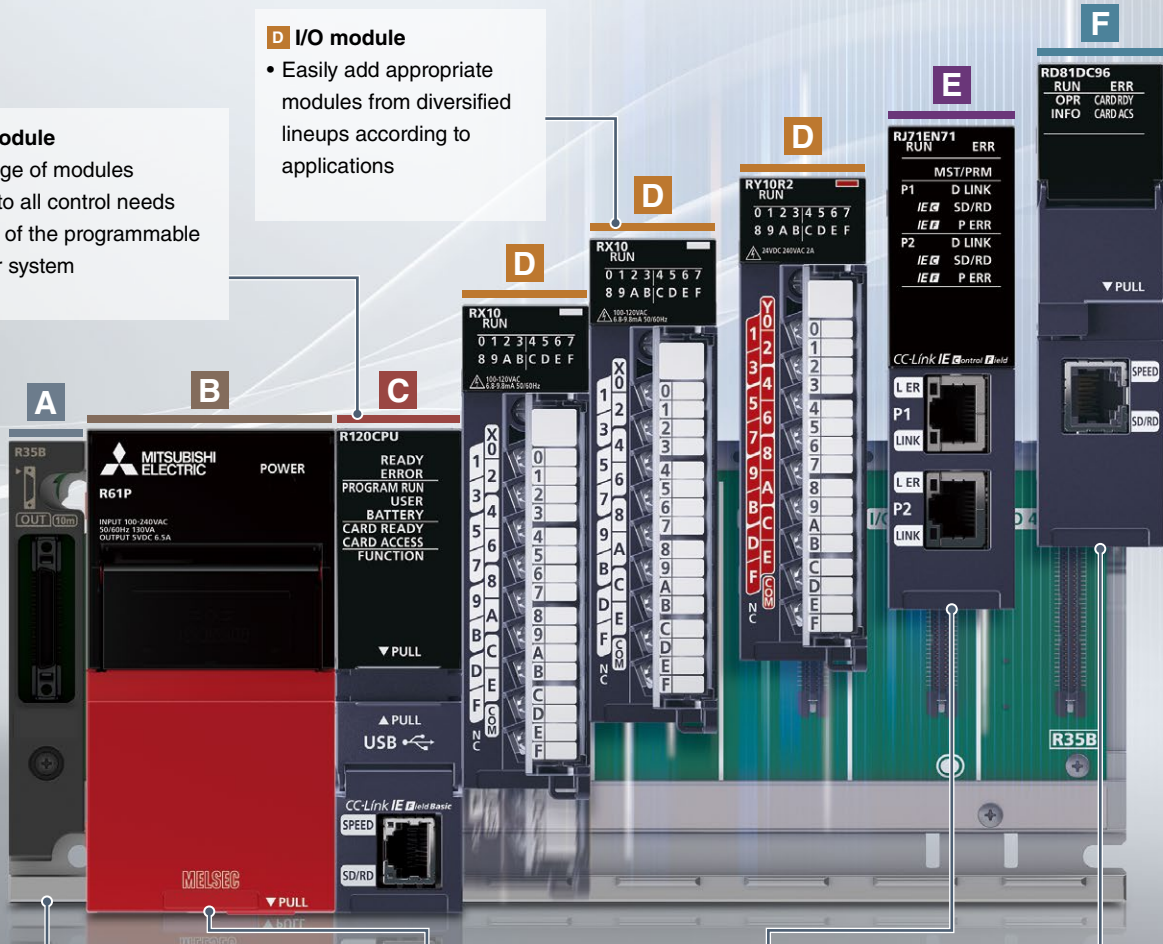

**A Base unit**

- Variety of base units are available according to the number of modules required to install
- Base units and extension base units with many slots support future system expansion

**B Power supply module**

- Efficiently supplies power to all modules installed on the base unit

**E Network module**

- For connecting multiple systems

**F Advanced information module**

- Provides connectivity with IT systems for data communications and analysis

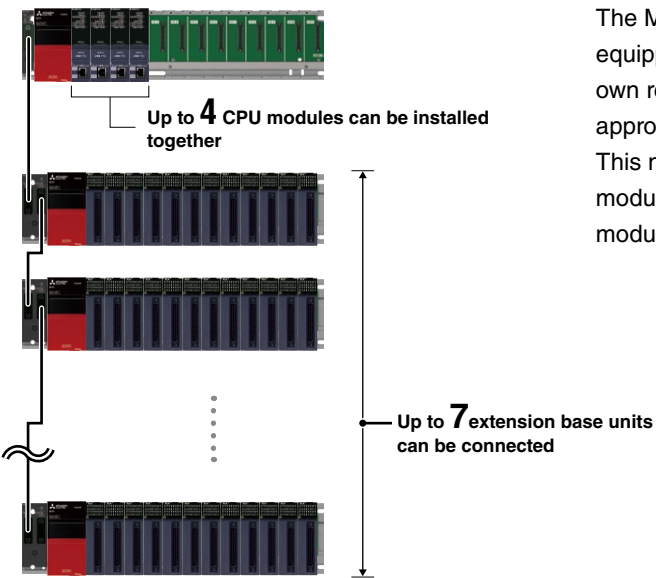

The MELSEC iQ-R Series is a modular control system equipped with various modules, each having its own responsibility in a system, enabling selection of appropriate modules according to the application. This modular design allows easy replacement of faulty modules when an error occurs and addition of necessary modules for system expansion.



# Lineup

## A

### Base

P.150

- Main base
- Slim type main base **NEW**
- Redundant power supply main base
- Extended temperature range main base
- Extended temperature range redundant power supply main base
- Extension base
- Redundant power supply extension base
- Redundant extension base
- Extended temperature range extension base
- Extended temperature range redundant power supply extension base
- Extended temperature range redundant extension base
- RQ extension base
- Extension cable

## B

### Power supply

P.150

- Power supply
- Slim type power supply **NEW**
- Redundant power supply

## C

### CPU modules

P.50

Core of the programmable controllers according to application requirements

- Programmable controller CPU
- Motion CPU
- Safety CPU
- Process CPU
- SIL2 process CPU
- Redundant function
- C Controller
- C intelligent function
- MELSECWinCPU

## D

### I/O modules

P.76

Interface between the controller and various devices processing digital binary signals

- Input
- Output
- I/O combined
- I/O with diagnostic functions
- I/O with safety functions **NEW**

### Analog, temperature input, and temperature control modules

P.84

Interface between the controller and various analog devices processing varying voltage, current, and temperature signals

- Analog input
- Analog output
- Temperature input
- Temperature control

### Motion and positioning modules

P.96

Intelligent function modules executing fast and high-accuracy motion control, positioning control, and position detection by simple programming

- Motion
- Simple motion
- Positioning

## E

### Network modules

P.108

Network and interface modules providing the best-fit network solution from the upper level to the field level

- CC-Link IE TSN master/local
- CC-Link IE TSN Plus master/local
- CC-Link IE Controller Network
- CC-Link IE Field Network master/local
- CC-Link IE Field Network remote head
- CC-Link system master/local
- AnyWireASLINK master
- MELSECNET/H network (Optical loop type, coaxial bus type)
- BACnet®
- EtherNet/IP network interface (scanner)
- CIP Safety™ (scanner)
- CANopen®
- DeviceNet master/slave
- PROFIBUS-DP
- PROFINET IO
- GP-IB interface
- Ethernet interface
- Serial communication

CC-Link IE TSN-compatible network products

- CC-Link IE TSN-compatible block-type remote
- CC-Link IE TSN-compatible bridge

## F

### Advanced information modules

P.130

Intelligent function modules provide connectivity between the IT system and the shop floor for data communications and analysis

- Recorder
- Camera recorder
- MES interface
- OPC UA server
- High-speed data logger
- High-speed data communication

### FPGA\*1 modules

P.106

Modules capable of high-speed and highly-accurate input/output control

- CC-Link IE TSN-compatible FPGA module\*2

\*1. FPGA stands for field programmable gate array.

\*2. The module can operate stand-alone without having to use the base unit and also can be connected to the programmable controller using CC-Link IE TSN or Ethernet.

### High-speed counter, isolated pulse, and flexible high-speed I/O modules

P.102

Intelligent function modules executing high-speed/high-accuracy control by high-speed pulse measurement and responses

- High-speed counter
- Channel isolated pulse input
- Flexible high-speed I/O control

### Energy measuring module

P.137

A module ideal for energy saving and predictive maintenance at the manufacturing site

- Energy measuring

## Ideal CPUs according to required controls and development environment

### General control



General control

#### Programmable controller CPU module

P.52

Program capacity from 10K to 1200K steps

**R□□CPU**

CPU module embedded with network function (CC-Link IE)

**R□□ENCPU**

### Motion control



Highly accurate motion control by various positioning programs

#### Motion CPU module

P.58

Number of control axes from 16 to 64 axes

**R16MTCPU**

**R32MTCPU**

**R64MTCPU**

### Safety control



Safety control allows cooperative work with an operator and a machine

#### Safety CPU module

P.61

Program capacity from 80K to 1200K steps

**R□□SFCPU-SET**

## Process control



Easily replace the DCS with the programmable controller  
**Process CPU module, SIL2 process CPU module, Redundant function module**

**P.64**

Program capacity from 80K to 1200K steps  
**R□□PCPU**  
 SIL 2-supporting CPU module  
**R□□PSFCPU-SET**  
 Redundant function module  
**R6RFM**

## C language programming

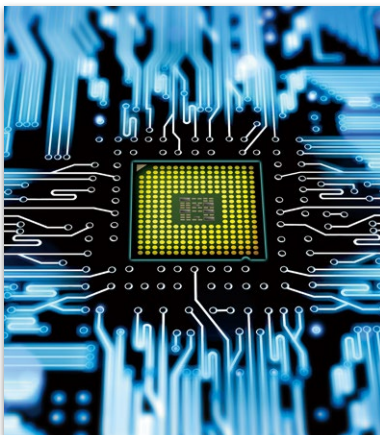

Execute C/C++ program with the programmable controller

**C Controller module**  
**C intelligent function module**

**P.69**

Execute real-time control  
**R12CCPU-V**  
 Information processing  
**RD55UP06-V**  
**RD55UP12-V**

## General programming



Control and information processing utilizing Windows® on the base unit

**MELSECWinCPU module**

**P.74**

Equipped with Microsoft® Windows® 10, a fan-less hardware design  
**R102WCPU-W**

CPU
I/O
Analog/temperature input/temperature control
Motion/positioning
High-speed counter/isolated pulse/flexible high-speed I/O
FPGA
Network
Advanced information
Energy measuring
Software

# Programmable controller CPU module

The CPU modules are the heart of the control system performing variety control tasks. Different CPUs with program capacity from 10K to 1200K steps are available based on the system requirement. Equipped with various internal functions such as web server and database, contributing to productivity improvement.

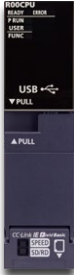
Large-scale		Medium-scale	
	<ul style="list-style-type: none"> <li><b>R04CPU</b> 40K</li> <li><b>R08CPU</b> 80K</li> <li><b>R16CPU</b> 160K</li> <li><b>R32CPU</b> 320K</li> <li><b>R120CPU</b> 1200K</li> </ul>		<ul style="list-style-type: none"> <li><b>R00CPU</b> 10K</li> <li><b>R01CPU</b> 15K</li> <li><b>R02CPU</b> 20K</li> </ul>

## Embedded network

CC-Link IE embedded programmable controller CPU module. Dual Ethernet ports on the network side can be used as a gateway. The Ethernet port on the CPU side is used as an Ethernet communications port.

	<ul style="list-style-type: none"> <li><b>R04ENCPU</b> 40K</li> <li><b>R08ENCPU</b> 80K</li> <li><b>R16ENCPU</b> 160K</li> <li><b>R32ENCPU</b> 320K</li> <li><b>R120ENCPU</b> 1200K</li> </ul>	<p><b>Network combination**</b></p> <table border="1"> <tr> <td>P1</td> <td>C</td> <td>F</td> <td>E</td> <td>E</td> </tr> <tr> <td>P2</td> <td></td> <td></td> <td>C</td> <td>F</td> </tr> </table> <p> <b>C</b> : CC-Link IE Controller Network  <b>F</b> : CC-Link IE Field Network  <b>E</b> : Ethernet                 </p> <p>*1. The CC-Link IE Field and CC-Link IE Controller Networks cannot be used together.</p>	P1	C	F	E	E	P2			C	F
P1	C	F	E	E								
P2			C	F								

## Interface

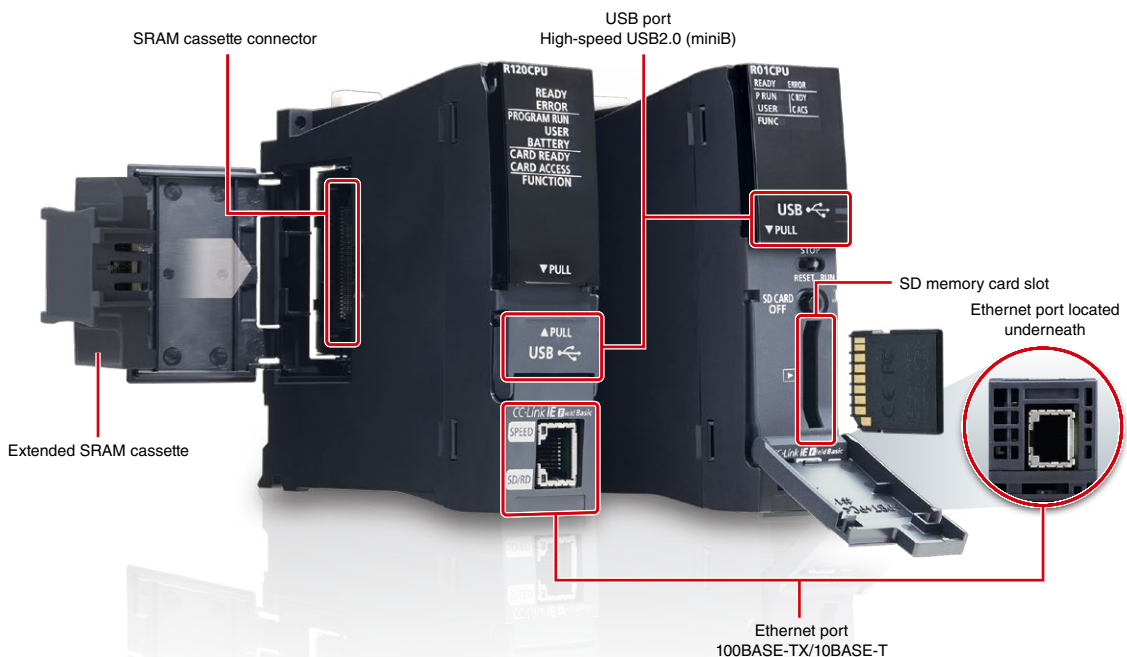

### Easy programming with flexible, large-capacity data storage

Max. 9882K words      Easy programming      Data utilization

- The MELSEC iQ-R Series programmable controller CPU module is designed to allow an extended SRAM cassette to be installed directly into the CPU module. This option makes it possible to increase internal device memory up to 9882K words, expanding device/label memory even further
- Management of programmable controller internal data is quite flexible, making programming even easier by allowing various data area allocations to be changed within the CPU memory and SRAM cassette
- Use of an SD memory card expands data logging memory, which allows data analysis by computer

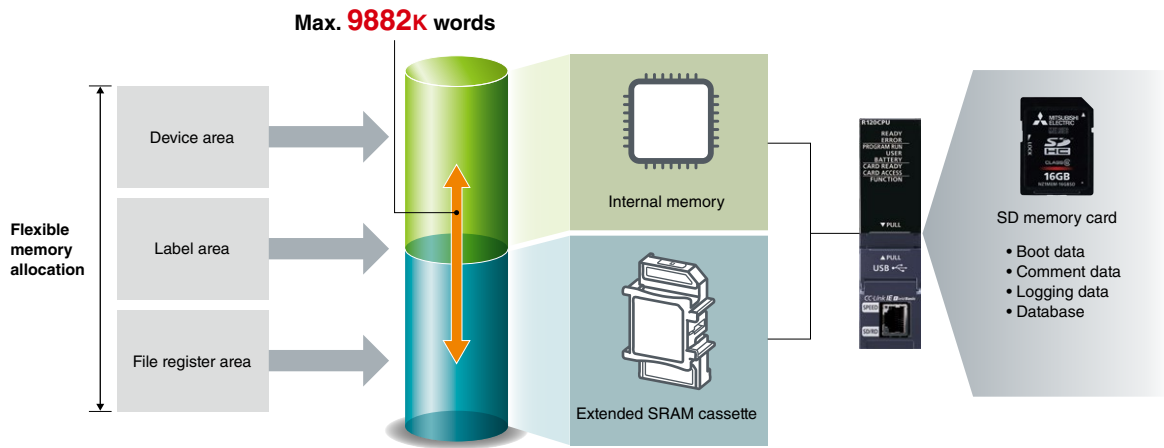

### Accurately detect high-speed signals

Constant interrupt      50 μs of minimum interval time      High-speed control

- Execute interrupt programs at a constant cycle (50 μs of minimum interval time) different from the scan time
- All signals are detected as input processing can be done faster than the scan time. This is ideal for a production line where products are traveling at high speed

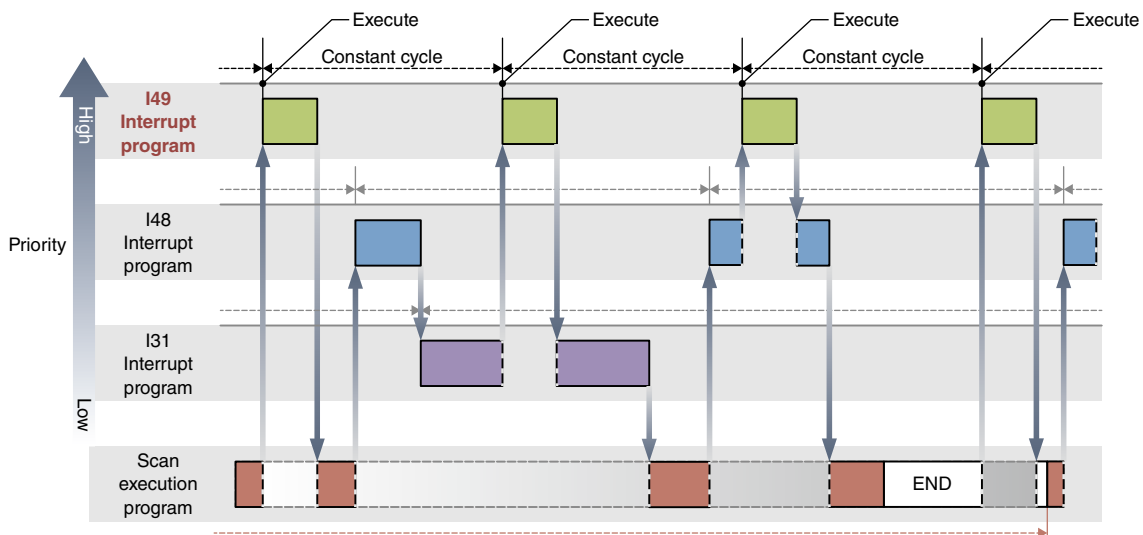

- CPU
- I/O
- Analog/temperature input/temperature control
- Motion/positioning
- High-speed counter/isolated pulse/flexible high-speed I/O
- FFGA
- Network
- Advanced information
- Energy measuring
- Software

**Recorded event history can be checked when an error occurs**

Display in time-series

Error cause identification

Troubleshooting

- Operation and system historical events are automatically recorded in the programmable controller CPU module
- Actual changes to the program and system events with corresponding event codes can be displayed in sequence, allowing prompt error cause identification and troubleshooting

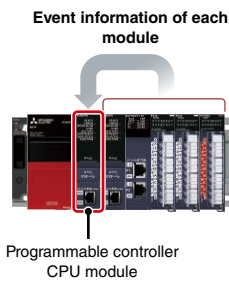

No.	Occurrence Date	Event Type	Status	Event Code	Overview
00004	2014/06/06 14:25:56.798	System	!	00400	Power-on and reset
00005	2014/06/06 14:16:34.026	Svstem	!	01000	Power shutoff
00006	2014/06/06 14:11:00.100	Operation	!	24200	Creation of new folders, writes to fi
00007	2014/06/06 14:04:39.417	Operation	!	24200	Creation of new folders, writes to fi
00008	2014/06/06 13:59:53.360	Operation	!	24100	Operating status change (RUN)
00009	2014/06/06 13:59:51.431	System	!	00400	Power-on and reset
00010	2014/06/06 9:58:33.542	Svstem	!	020F0	Invalid module

Events can be checked in sequence

Detailed Information	Operation initiator information	Drive and file information
Cause	Connection port :USB	Drive name :Data memory File name :MAIN.PRG
Corrective Action	- A new folder was created. A new file was created or data was writt	

Details, causes, and troubleshooting of each event can be checked

**Easily collect manufacturing data**

Save in the internal memory

Traceability

Debug

- Utilizing the installed SD memory card, CPU internal memory or a direct live connection to the CPU module, logging data (device/label) can be easily collected just by simply registering the parameters. In addition, monitoring via USB or Ethernet in real-time is possible
- With the real-time monitor function of GX LogViewer, small changes in the target device can be easily identified, which is useful for factory traceability, equipment startup, and debugging in case of an error

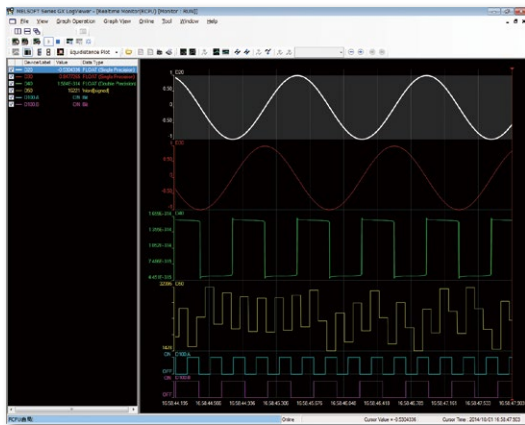

GX LogViewer monitoring screen

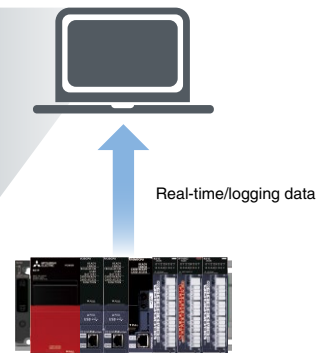

## Easy diagnostics/monitoring via a web browser

CPU diagnostics

Device block monitor

Customized web page

- The Web server function built into the CPU enables easy access to CPU diagnostics and device batch monitor via a PC or tablet web browser without the need to create graphics
- Preliminary diagnostics can be easily performed when a problem occurs, without the need to connect the engineering software GX Works3
- The user web page design tool allows customers to easily create their own graphics by freely arranging the various graphic components provided\*1

\*1. For details on how to obtain software, please contact your local Mitsubishi Electric sales office or representative.

**Basic diagnostics screen of the module**

Model Name	R04MCPU
Production Information	
FW Version	1.0
System Webpage Version	1.0
IP Address	192.168.1.10
MAC Address	19:96:43:00:00:00
Date	2019-04-01
Time	13:56:43 UTC+9 DST

**User web page design tool screen**

No.	Product name	Area	Production rate	Starting date	Latest date	Countdown
1	Product A	Area A	200005	201905	201905	102
2	Product B	Area B	200115	201911	201911	102
3	Product C	Area C	201030	201923	201923	305
4	Product D	Area D	200202	201906	201906	256
5	Product E	Area E	200410	201914	201914	463
6	Product F	Area F	200605	201923	201923	190

## Easy data coordination with third-party programmable controllers just by registering parameters

Parameter registration only

Coordination with third-party controllers

Easy data collection

- The programmable controller CPU module allows device data exchange by parameter registration with Mitsubishi Electric programmable controllers and third-party programmable controllers\*2 (simple CPU communication function)\*3
- Data collection is easier without changing programs of the existing programmable controllers

\*2. When R□ENCPU (network part) or R□J1EN71 is used, it is possible to connect to a third-party programmable controller.

\*3. For the list of connectable devices, please see the link below.

[www.MitsubishiElectric.com/fa/ref/ref.html?k=plcr&pmerit=simple\\_cpu\\_com](http://www.MitsubishiElectric.com/fa/ref/ref.html?k=plcr&pmerit=simple_cpu_com)

**Device data exchange program**

```

[ S1.SOCOPEN ]
[ S2.SOCSEND ]
[ S3.SOCRCV ]
[ S4.SOCRCV ]
[ S5.SOCRCV ]
[ S6.SOCRCV ]
[ S7.SOCRCV ]
[ S8.SOCRCV ]
[ S9.SOCRCV ]
[ S10.SOCRCV ]
[ S11.SOCRCV ]
[ S12.SOCRCV ]
[ S13.SOCRCV ]
[ S14.SOCRCV ]
[ S15.SOCRCV ]
[ S16.SOCRCV ]
[ S17.SOCRCV ]
[ S18.SOCRCV ]
[ S19.SOCRCV ]
[ S20.SOCRCV ]
[ S21.SOCRCV ]
[ S22.SOCRCV ]
[ S23.SOCRCV ]
[ S24.SOCRCV ]
[ S25.SOCRCV ]
[ S26.SOCRCV ]
[ S27.SOCRCV ]
[ S28.SOCRCV ]
[ S29.SOCRCV ]
[ S30.SOCRCV ]
[ S31.SOCRCV ]
[ S32.SOCRCV ]
[ S33.SOCRCV ]
[ S34.SOCRCV ]
[ S35.SOCRCV ]
[ S36.SOCRCV ]
[ S37.SOCRCV ]
[ S38.SOCRCV ]
[ S39.SOCRCV ]
[ S40.SOCRCV ]
[ S41.SOCRCV ]
[ S42.SOCRCV ]
[ S43.SOCRCV ]
[ S44.SOCRCV ]
[ S45.SOCRCV ]
[ S46.SOCRCV ]
[ S47.SOCRCV ]
[ S48.SOCRCV ]
[ S49.SOCRCV ]
[ S50.SOCRCV ]
[ S51.SOCRCV ]
[ S52.SOCRCV ]
[ S53.SOCRCV ]
[ S54.SOCRCV ]
[ S55.SOCRCV ]
[ S56.SOCRCV ]
[ S57.SOCRCV ]
[ S58.SOCRCV ]
[ S59.SOCRCV ]
[ S60.SOCRCV ]
[ S61.SOCRCV ]
[ S62.SOCRCV ]
[ S63.SOCRCV ]
[ S64.SOCRCV ]
[ S65.SOCRCV ]
[ S66.SOCRCV ]
[ S67.SOCRCV ]
[ S68.SOCRCV ]
[ S69.SOCRCV ]
[ S70.SOCRCV ]
[ S71.SOCRCV ]
[ S72.SOCRCV ]
[ S73.SOCRCV ]
[ S74.SOCRCV ]
[ S75.SOCRCV ]
[ S76.SOCRCV ]
[ S77.SOCRCV ]
[ S78.SOCRCV ]
[ S79.SOCRCV ]
[ S80.SOCRCV ]
[ S81.SOCRCV ]
[ S82.SOCRCV ]
[ S83.SOCRCV ]
[ S84.SOCRCV ]
[ S85.SOCRCV ]
[ S86.SOCRCV ]
[ S87.SOCRCV ]
[ S88.SOCRCV ]
[ S89.SOCRCV ]
[ S90.SOCRCV ]
[ S91.SOCRCV ]
[ S92.SOCRCV ]
[ S93.SOCRCV ]
[ S94.SOCRCV ]
[ S95.SOCRCV ]
[ S96.SOCRCV ]
[ S97.SOCRCV ]
[ S98.SOCRCV ]
[ S99.SOCRCV ]
[ S100.SOCRCV ]
    
```

**Device data exchange parameter setting**

Setting No.	Communication Pattern	Communication Setting Execution Interval(ms)	Communication Destination (IP Address)		Target PLC No.	Bit Device Points
			Source	Destination		
1	Write	Fixed	10 Host Station(192.168.11.10)	-> Mitsubishi Q(192.168.11.10)	Not Specified	32 A
2	Read	Fixed	10 Mitsubishi Q(192.168.11.10)	-> Host Station(192.168.11.10)	Not Specified	64 E
3	Write	Fixed	10 Host Station(192.168.11.10)	-> Mitsubishi L(192.168.11.12)	Not Specified	64 >
4	Read	Fixed	10 Mitsubishi L(192.168.11.12)	-> Host Station(192.168.11.10)	Not Specified	64 >
5						

**Only parameter registration is required.**

\*4. Supported by the embedded Ethernet port only.

CPU  
I/O  
Analog/temperature input/temperature control  
Motion/positioning  
High-speed counter/ isolated pulse/ flexible high-speed I/O  
FPGA  
Network  
Advanced information  
Energy measuring  
Software

### Easy data management utilizing internal database (DB)

Internal DB

Unicode®

Multiple product variations

- Recipe data and production data, previously managed using a database server, can now be managed via the database in the programmable controller
- This feature allows a selection of database commands that can add/update/search/delete records to be utilized for simple recipe functions
- Accessing the CPU internal database data from a computer with Access® or Excel® is supported
- Utilized for changing recipe data and production management in the food and beverage industry where multiple product variations are produced using the same machine process

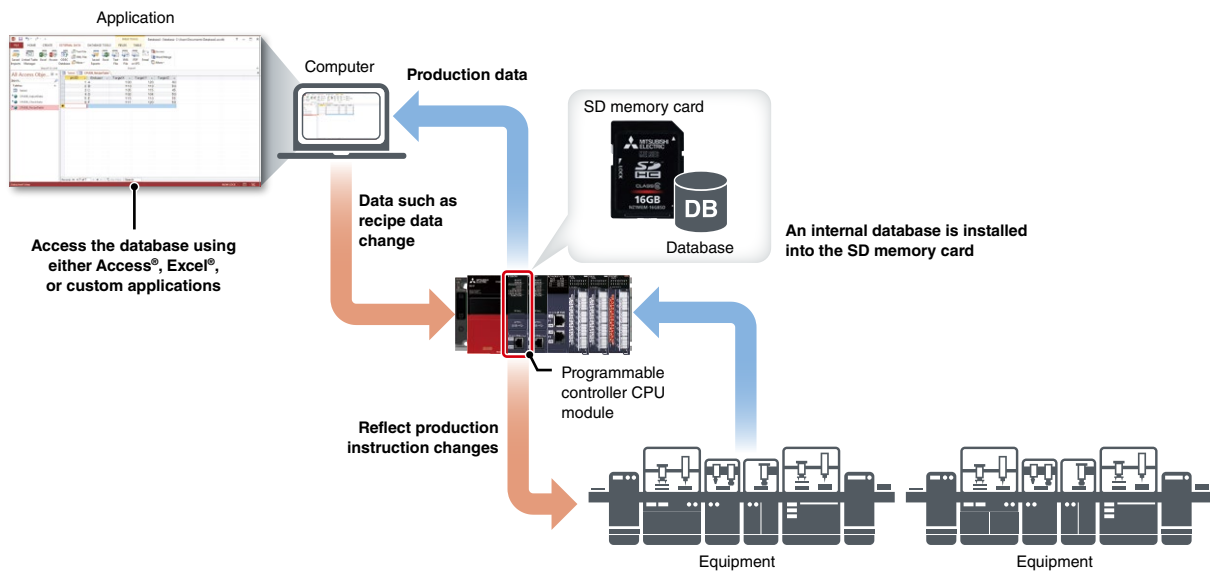

### Battery-less module reduces maintenance cost

- The programmable controller CPU module for the medium-scale system (R00CPU/R01CPU/R02CPU) includes embedded non-volatile memory, thereby retaining latch data of device and label without requiring a backup battery when the power is off
- Other programmable controller CPU modules can also store latch data without a battery by installing a battery-less option cassette
- Periodical battery replacement is no longer required, reducing maintenance cost



### Battery-less option cassette (NZ1BLC)-compatible module

Item	Compatible modules
Programmable controller CPU module	R04(EN)CPU, R08(EN)CPU, R16(EN)CPU, R32(EN)CPU, R120(EN)CPU



Programmable controller CPU module specifications

LD : Ladder diagram ST : Structured text FBD : Function block diagram SFC : Sequential function chart

Item	R00CPU	R01CPU	R02CPU	R04(EN)CPU	R08(EN)CPU	R16(EN)CPU	R32(EN)CPU	R120(EN)CPU
Operation control method	Stored program cyclic operation							
I/O control mode	Refresh mode (Direct access I/O is available by specifying direct access I/O (DX, DY))							
Programming language	LD ST FBD SFC							
Extended programming language	Function block (FB), label programming (system/local/global)							
Program execution type	Initial, scan, fixed scan, event execution, standby							
Number of I/O points (X/Y)	4096	4096	4096	4096	4096	4096	4096	4096
Constant scan (ms) (function for keeping regular scan time)	0.5...2000 (setting available in 0.1 ms increments)			0.2...2000 (setting available in 0.1 ms increments)				
Memory capacity								
Program capacity (step)	10K	15K	20K	40K	80K	160K	320K	1200K
Program memory (byte)	40K	60K	80K	160K	320K	640K	1280K	4800K
Device/label memory*1 (byte)	252K	252K	252K	400K	1188K	1720K	2316K	3380K
Data memory (byte)	1.5M	1.5M	1.5M	2M	5M	10M	20M	40M
Instruction processing time								
LD instruction (ns)	31.3	31.3	3.92	0.98	0.98	0.98	0.98	0.98
MOV instruction (ns)	62.7	62.7	7.84	1.96	1.96	1.96	1.96	1.96
E + instruction (floating-point addition) (ns)	100.0	100.0	17.6	9.8	9.8	9.8	9.8	9.8
Structured text IF instruction*2 (ns)	31.3	31.3	3.92	1.96	1.96	1.96	1.96	1.96
Structured text FOR instruction*2 (ns)	31.3	31.3	3.92	1.96	1.96	1.96	1.96	1.96
PC MIX value*3 (instructions/μs)	19	19	146	419	419	419	419	419
Interface connection port								
High-speed USB2.0 (minib)	●	●	●	●	●	●	●	●
Ethernet (100BASE-TX/10BASE-T)	●	●	●	●	●	●	●	●
CC-Link IE connection port								
Ethernet (1000BASE-T/100BASE-TX/10BASE-T)	-	-	-	●*4*5	●*4*5	●*4*5	●*4*5	●*4*5
CC-Link IE Field Network Basic connection port								
Ethernet (100BASE-TX/10BASE-T)	●	●	●	●	●	●	●	●
Memory interface								
SD memory card	-	●	●	●	●	●	●	●
Extended SRAM cassette	-	-	-	●	●	●	●	●
Function								
Multiple interrupt	●	●	●	●	●	●	●	●
Standard PID control	●	●	●	●	●	●	●	●
Internal database	-	-	-	●	●	●	●	●
Memory dump	-	●	●	●	●	●	●	●
Data logging	-	●*6	●*6	●	●	●	●	●
Real-time monitor	●	●	●	●	●	●	●	●
Security	●	●	●	●	●	●	●	●
Inter-module synchronization	●	●	●	●	●	●	●	●
SLMP communication	●	●	●	●	●	●	●	●
Simple CPU communication	●	●	●	●	●	●	●	●
Web server	●	●	●	●	●	●	●	●

\*1. An extended SRAM cassette expands the device/label memory area.  
 \*2. The IF or FOR sentence of the structured text consists of several instructions, which may increase the processing time period.  
 \*3. Average number of instructions such as for basic instructions and data processing executed in 1 μs. The larger the value, the faster the processing speed.  
 \*4. Available with R□ENCPU. For details about network specifications, please refer to the RJ71EN71 performance specifications on page 125.  
 \*5. The following networks are supported, Ethernet, CC-Link IE Control (twisted pair cable), and CC-Link IE Field (two simultaneous Ethernet networks and combined CC-Link IE Field and CC-Link IE Controller Networks are not supported).  
 \*6. Logging data can be saved in the SD memory card only.

SD memory card\*7 specifications

Item	NZ1MEM-2GBSD	NZ1MEM-4GBSD	NZ1MEM-8GBSD	NZ1MEM-16GBSD
Type	SD memory card	SDHC memory card	SDHC memory card	SDHC memory card
Capacity (byte)	2G	4G	8G	16G

\*7. SD memory card is not supported for the R00CPU.

Extended SRAM cassette specifications

Item	NZ2MC-1MBS	NZ2MC-2MBS	NZ2MC-2MBSE	NZ2MC-4MBS	NZ2MC-8MBS	NZ2MC-8MBSE	NZ2MC-16MBS
Capacity (byte)	1M	2M	2M	4M	8M	8M	16M
ECC type	-	-	●	-	-	●	-
Supported CPU modules							
Programmable controller CPU*8	●	●	-	●	●	-	●
Process CPU	-	-	●	-	-	●	-
SIL2 process CPU	-	-	●	-	-	●	-
Safety CPU	●	●	●	●	●	●	-

\*8. Not supported for R00CPU, R01CPU, R02CPU.

CPU

I/O

Analog/temperature input/temperature control

Motion/positioning

High-speed counter/isolated pulse/flexible high-speed I/O

FPGA

Network

Advanced information

Energy measuring

Software

# Motion CPU module

The motion CPU module is incorporated into the multiple CPU configuration, separating the CPU load efficiently. High-speed general control and high-accuracy motion control are achieved, thereby contributing to high-speed and high-accuracy machine processing.



<b>R16MTCPU</b>	<b>16-axis</b>
<b>R32MTCPU</b>	<b>32-axis</b>
<b>R64MTCPU</b>	<b>64-axis</b>

## Interface

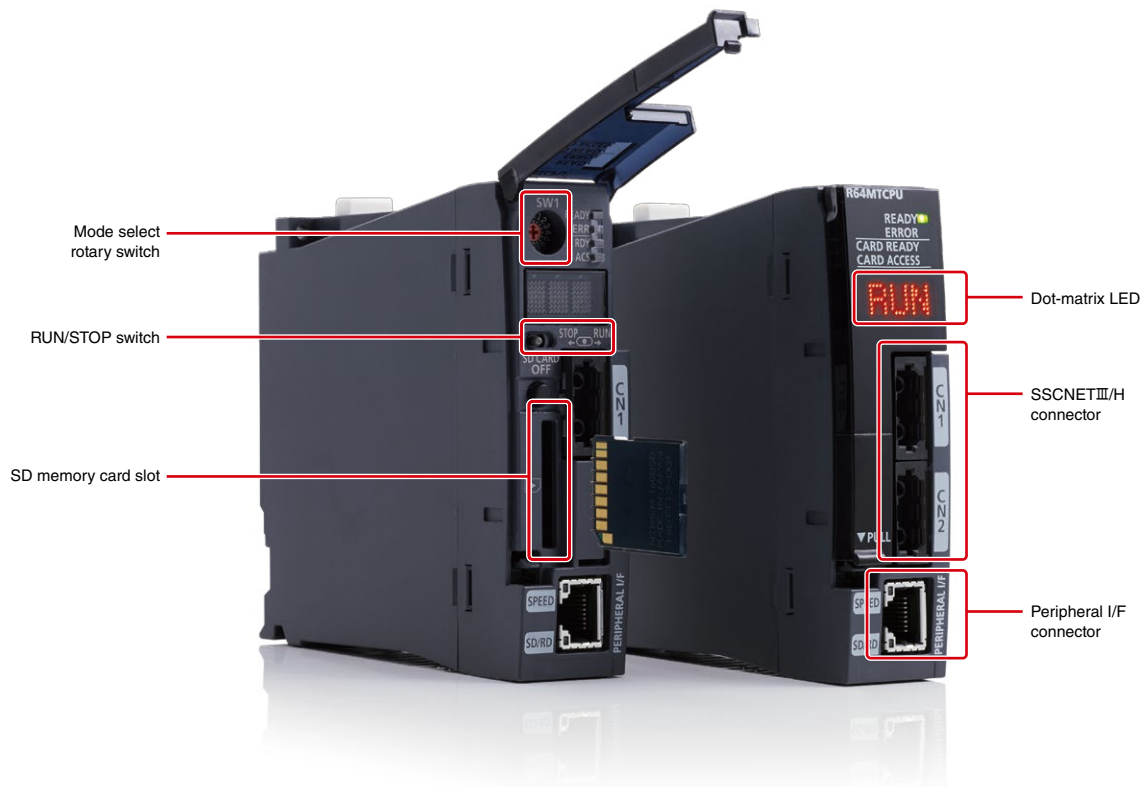

## High-speed and large-capacity communications between the CPU modules

### Large-capacity data communication

- In the multiple CPU configuration with the programmable controller CPU module and motion CPU module, a large memory area shared for high-speed data communication is provided
- High-speed communications are very useful when there is a need to instantaneously transfer a large amount of information such as cam data, thereby simplifying programming even further
- Useful for production lines responding to high variety and variable quantity production where recipe data needs to be instantly reflected to the motor operation according to commands from the computer

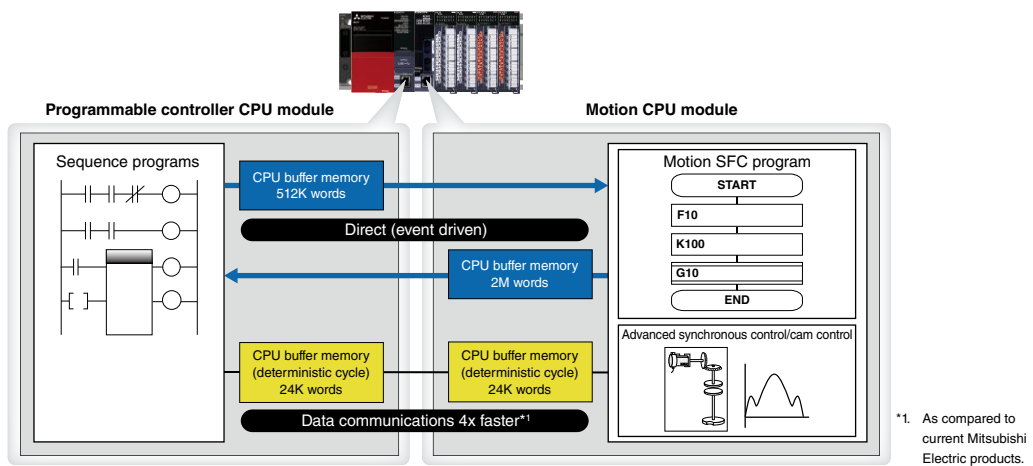

## Various applications easily realized

### Synchronous control

### Vision system

### G-code

- Simple configuration of a converting equipment that requires high-precision synchronization between motors and stable machining with constant tension

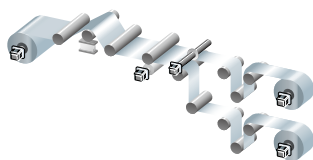

Converting equipment

- In cooperation with the vision system, it is possible to configure an alignment device that moves accurately, quickly and continuously according to the device position

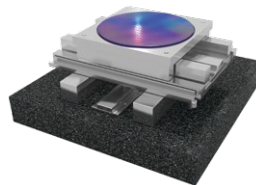

Positional alignment

- Execution of G-code programs used in a processing machine enables simple machine tool and punching



Processing machine

N10 G01 X800, Y430, F13800.  
 N11 G03 X880, Y350, I880, J430.  
**N12 G01 Y100.**  
 N13 G03 X800, Y20, I880, J20.  
 N14 G01 X100.  
 N15 G03 X20, Y100, I20, Y20.  
 N16 G01 Y350.  
 N17 G03 X100, Y430, I20, J430.

CPU

I/O

Analog/  
temperature input/  
temperature control

Motion/  
positioning

High-speed counter/  
isolated pulse/  
flexible high-speed I/O

FFGA

Network

Advanced  
information

Energy  
measuring

Software

## Motion SFC program with easy-to-understand processing steps

Flowchart

Event responsiveness

■ The motion CPU module is programmed using the SFC\*1 type language which enables programming in clearly identifiable steps

■ The motion SFC program is extremely useful for equipment and production lines requiring fast response

\*1. SFC: Sequential Function Chart

### Motion SFC Program

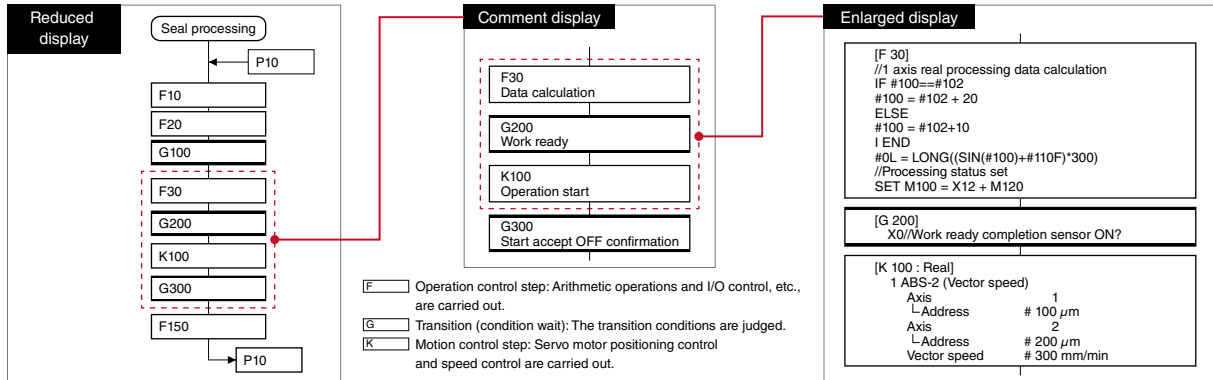

### Motion CPU module specifications

MT SFC : Motion SFC    INS : Dedicated instruction





Item	R16MTCPU	R32MTCPU	R64MTCPU
Max. number of control axes	16	32 (16 axes x 2 lines)	64 (32 axes x 2 lines)
Operation cycle setting (ms)	0.222, 0.444, 0.888, 1.777, 3.555, 7.111	0.222, 0.444, 0.888, 1.777, 3.555, 7.111	0.222, 0.444, 0.888, 1.777, 3.555, 7.111
Programming language	MT SFC    INS	MT SFC    INS	MT SFC    INS
Servo program capacity (step)	64K	64K	64K
Number of positioning points	6400 (positioning data can be designated indirectly)	6400 (positioning data can be designated indirectly)	6400 (positioning data can be designated indirectly)
Servo amplifier network	SSCNETⅢ/H (1 line)	SSCNETⅢ/H (2 lines)	SSCNETⅢ/H (2 lines)
Max. distance between stations (m)	100	100	100
<b>Interpolation</b>			
Linear interpolation (axis)	Max. 4	Max. 4	Max. 4
Circular interpolation (axis)	2	2	2
Helical interpolation (axis)	3	3	3
<b>Control mode</b>			
Positioning control	●	●	●
Continuous path control	●	●	●
Position follow-up control	●	●	●
Advanced synchronous control	●	●	●
Speed-torque control	●	●	●
G-code control*2	●	●	●
<b>Acceleration/deceleration control</b>			
Trapezoidal acceleration/deceleration	●	●	●
S-curve acceleration/deceleration	●	●	●
Advanced S-curve acceleration/deceleration	●	●	●
<b>Interface</b>			
PERIPHERAL I/F	●	●	●
SD memory card	●	●	●
<b>Function</b>			
Absolute position system*3	●	●	●
Mark detection function	●	●	●
Digital oscilloscope function	●	●	●
Driver communication function	●	●	●

\*2. G-code control is available by additionally installing the G-code control add-on library. For more information, please contact your local Mitsubishi Electric sales office or representative.

\*3. Supported when a battery is connected to the servo amplifier. A battery is not required when using a servo motor equipped with a battery-less absolute position encoder.

# Safety CPU module

The safety CPU module that is compliant with internationally recognized safety standards enables both general control and safety control which can safely stop a machine. In cooperation with safety drives, a system ensuring safety while avoiding frequent mechanical stops can be configured.

ISO 13849-1 PL e	IEC 61508 SIL 3
	<b>R08SFCPU-SET</b> 80K*1
	<b>R16SFCPU-SET</b> 160K*1
	<b>R32SFCPU-SET</b> 320K*1
	<b>R120SFCPU-SET</b> 1200K*1

\*1. The program capacity of the safety control is 40K steps.

## Interface

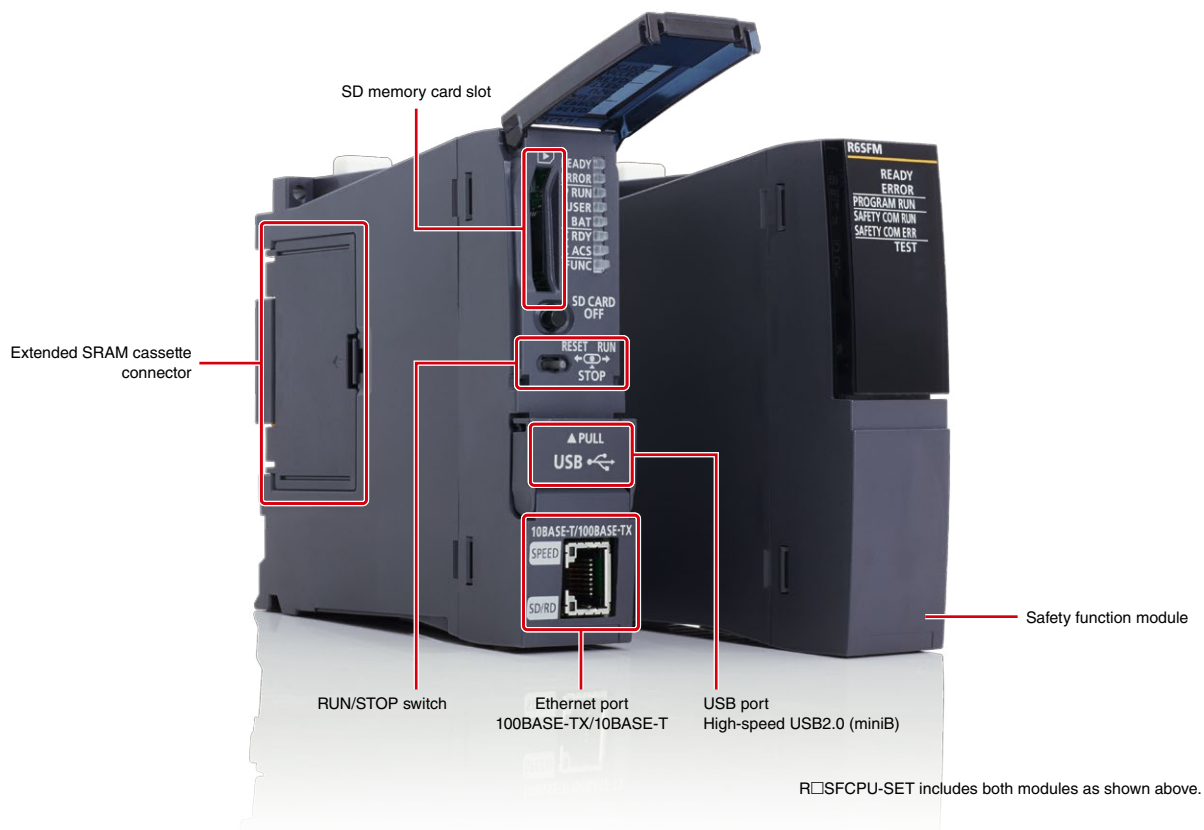

CPU
I/O
Analog/temperature input/temperature control
Motion/positioning
High-speed counter/ isolated pulse/ flexible high-speed I/O
FPGA
Network
Advanced information
Energy measuring
Software

### Safety and general control in one CPU module

One system

Space-saving

Cost reduction

- Using the safety CPU module on CC-Link IE TSN or CC-Link IE Field Network can execute both general and safety programs, enabling easy integration into one control system
- Installation of separate programmable controllers and networks is unnecessary, saving on space and costs

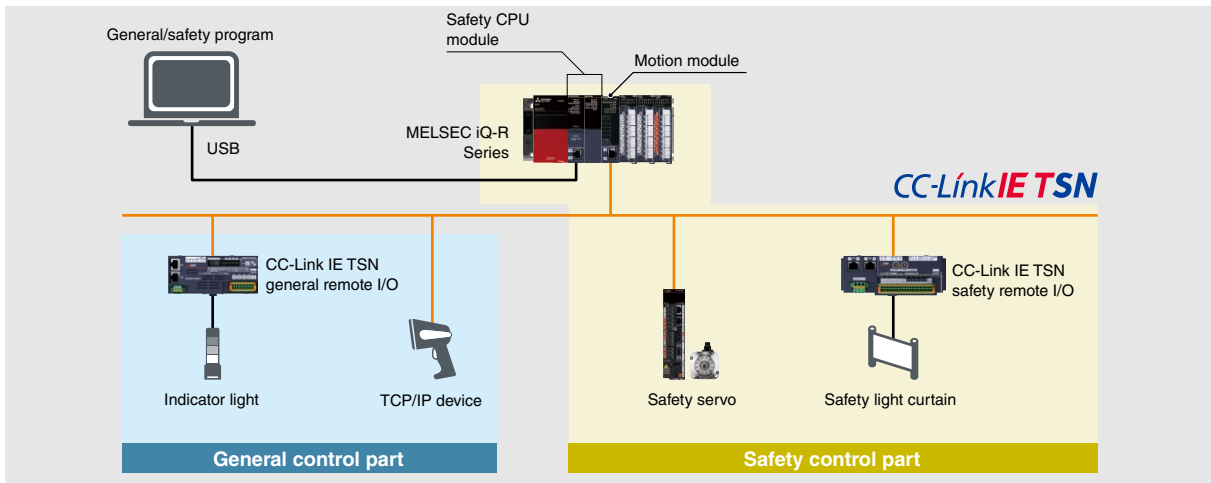
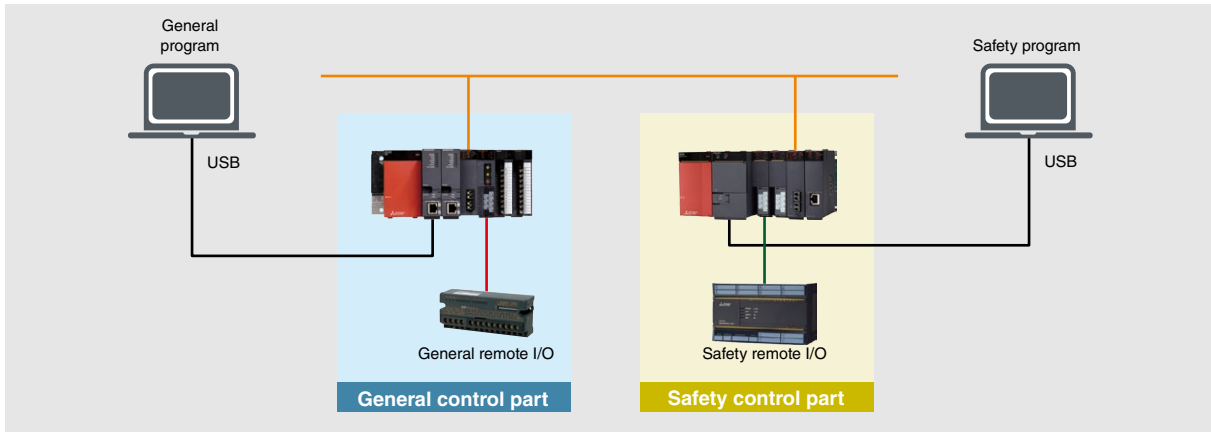

## General and safety programs in the common engineering platform

Integrated program

- In engineering software GX Works3, general programs and safety programs are included in the same project folder
- The need to manage multiple project folders is eliminated

Safety CPU module integrated into main system configuration

Manage program files for safety control on GX Works3

Integrated safety CPU module parameters

Safety devices easily recognized as appended with "SAI"

### Safety CPU module specifications

Item	LD : Ladder diagram    ST : Structured text    FBD : Function block diagram    SFC : Sequential function chart			
	R08SFCPU-SET*1	R16SFCPU-SET*1	R32SFCPU-SET*1	R120SFCPU-SET*1
Safety integrity level (SIL)	SIL 3 (IEC 61508)			
Performance level (PL)	PL e (EN/ISO 13849-1)			
Operation control method	Stored program cyclic operation			
I/O control mode	Refresh mode (Direct access I/O is available by specifying direct access I/O (DX, DY))			
Programming language	LD    ST *2    FBD *2    SFC			
Extended programming language	Function block (FB), label programming (local/global)			
Program execution type	Fixed scan, initial*2, scan*2, event execution*2, standby*2			
<b>Memory capacity</b>				
Program capacity (step)	80K (40K for safety programs)*3	160K (40K for safety programs)*3	320K (40K for safety programs)*3	1200K (40K for safety programs)*3
Program memory (byte)	320K	640K	1280K	4800K
Device/label memory*4 (byte)	1178K	1710K	2306K	3370K
Data memory (byte)	5M	10M	20M	40M
<b>Function</b>				
SLMP communication	●	●	●	●
Simple CPU communication*5*6	●	●	●	●

\*1. Product package includes a safety CPU module (R□SFCPU) and safety function module (R6SFM).  
 \*2. Cannot be used for safety control programs.  
 \*3. Up to 40K steps of the program capacity can be used for safety programs.  
 \*4. An extended SRAM cassette expands the device/label memory area.  
 \*5. Simple CPU communication function is supported in the module firmware version of "30" or later.  
 \*6. For the list of connectable devices supporting simple CPU communication function, please see the link below.  
[www.MitsubishiElectric.com/fa/ref/ref.html?k=plcr&pmerit=simple\\_cpu\\_com](http://www.MitsubishiElectric.com/fa/ref/ref.html?k=plcr&pmerit=simple_cpu_com)

CPU

I/O

Analog/ temperature input/ temperature control

Motion/ positioning

High-speed counter/ isolated pulse/ flexible high-speed I/O

FFGA

Network

Advanced information

Energy measuring



Software

# Process CPU module

## SIL2 process CPU module

### Redundant function module

The process CPU modules are highly flexible according to process applications from simple loop control to complicated loop control. Initial and maintenance costs can be reduced by replacing a highly-specialized distributed control system (DCS) with a process programmable controller. When paired with the redundant function module, a highly reliable redundant control system is realized.

Process CPU module		Redundant function module	
	<b>R08PCPU</b>	<b>80K</b>	
	<b>R16PCPU</b>	<b>160K</b>	
	<b>R32PCPU</b>	<b>320K</b>	
	<b>R120PCPU</b>	<b>1200K</b>	

SIL2 process CPU module		
IEC 61508 SIL 2		
	<b>R08PSFCPU-SET</b>	<b>80K</b>
	<b>R16PSFCPU-SET</b>	<b>160K</b>
	<b>R32PSFCPU-SET</b>	<b>320K</b>
	<b>R120PSFCPU-SET</b>	<b>1200K</b>

### Interface

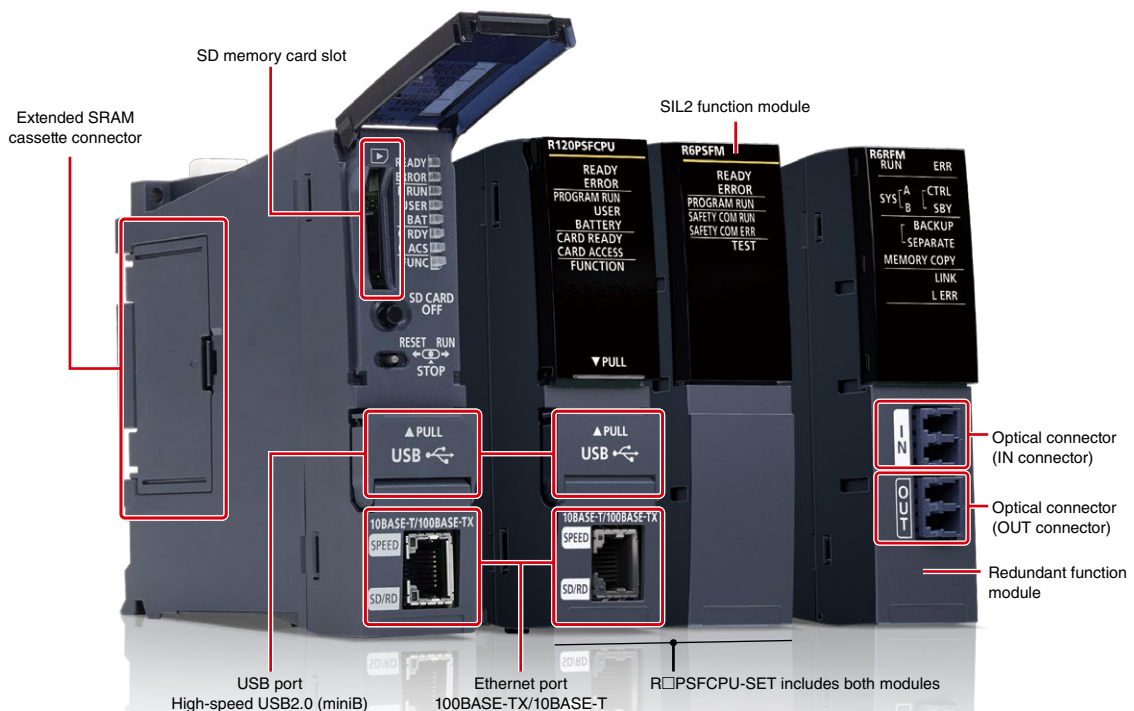

Redundant system when process CPU is paired with the redundant function module.



### DCS style features in a cost-efficient automation control system

Extensive process instructions

Max. 300 control loops

Low cost

- The process control system enables execution of dedicated process instructions (such as two-degree-of-freedom PID, sample PI, and auto-tuning) and large-scale process control with a maximum of 300 loops
- Low-cost automation system equal to DCS capabilities without the financial burden is realized

### Redundant system flexible installation

Extendable to 550 m

Flexible system configuration

- Optical-fiber tracking cables enable the standby system to be installed in a remote location up to 550 m from the control (primary) system
- The control panel installation is easier with less constraints to cable length, allowing flexible system configuration

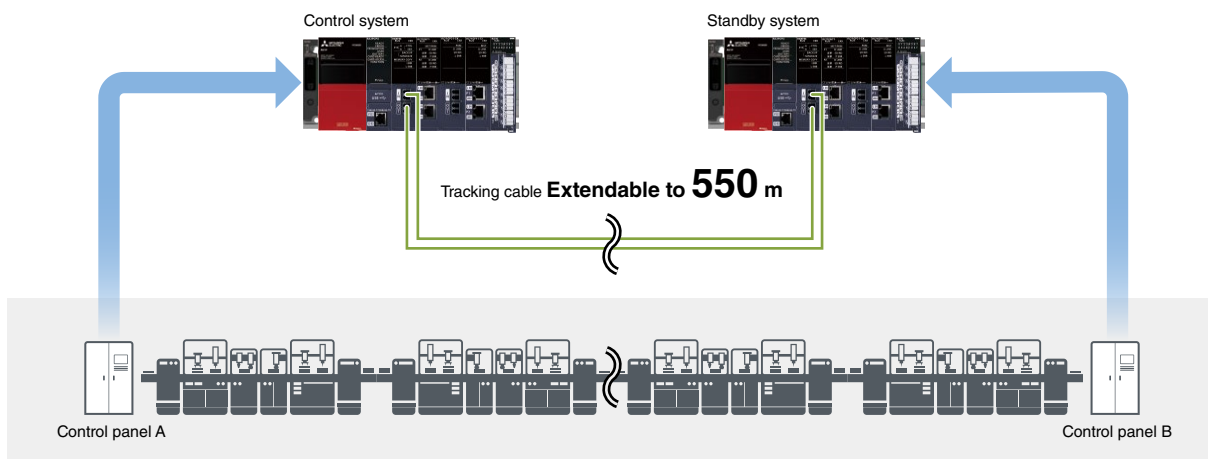

### Fast system switching realizes highly reliable control

Optical fiber cable

Fast system switching

Highly reliable

- The tracking cables are immune to noise interference and support fast data transfer rates
- System switching speed from the control system to standby system has also been improved to speeds of approximately 10 ms, further improving system reliability

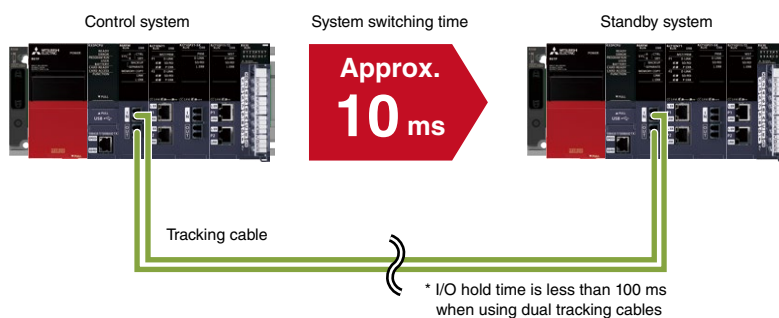

CPU

I/O

Analog/  
temperature input/  
temperature control

Motion/  
positioning

High-speed counter/  
isolated pulse/  
flexible high-speed I/O

FPGA

Network

Advanced  
information

Energy  
measuring

Software

### Operation not interrupted even when an error occurs

Single-point failure reduction

Variety of redundant configuration

Online replacement

The redundant system can minimize the risk of single-point failure in various redundant configurations which may vary depending on the use and the size of control system. Operation is not interrupted even when an error occurs

- A Redundant configuration consisting of the control (primary) and standby CPUs
- B Redundant extension cable with redundant extension base unit\*1
- C Redundant network configuration with a dual cable topology of CC-Link IE Field Network
- D Redundant remote head module (dual remote stations)

Online replacement of cables and modules (hot-swapping) is possible while continuously operating the system when an error occurs, enabling prompt troubleshooting

\*1. Supported by the process CPU module (R□PCPU) only.

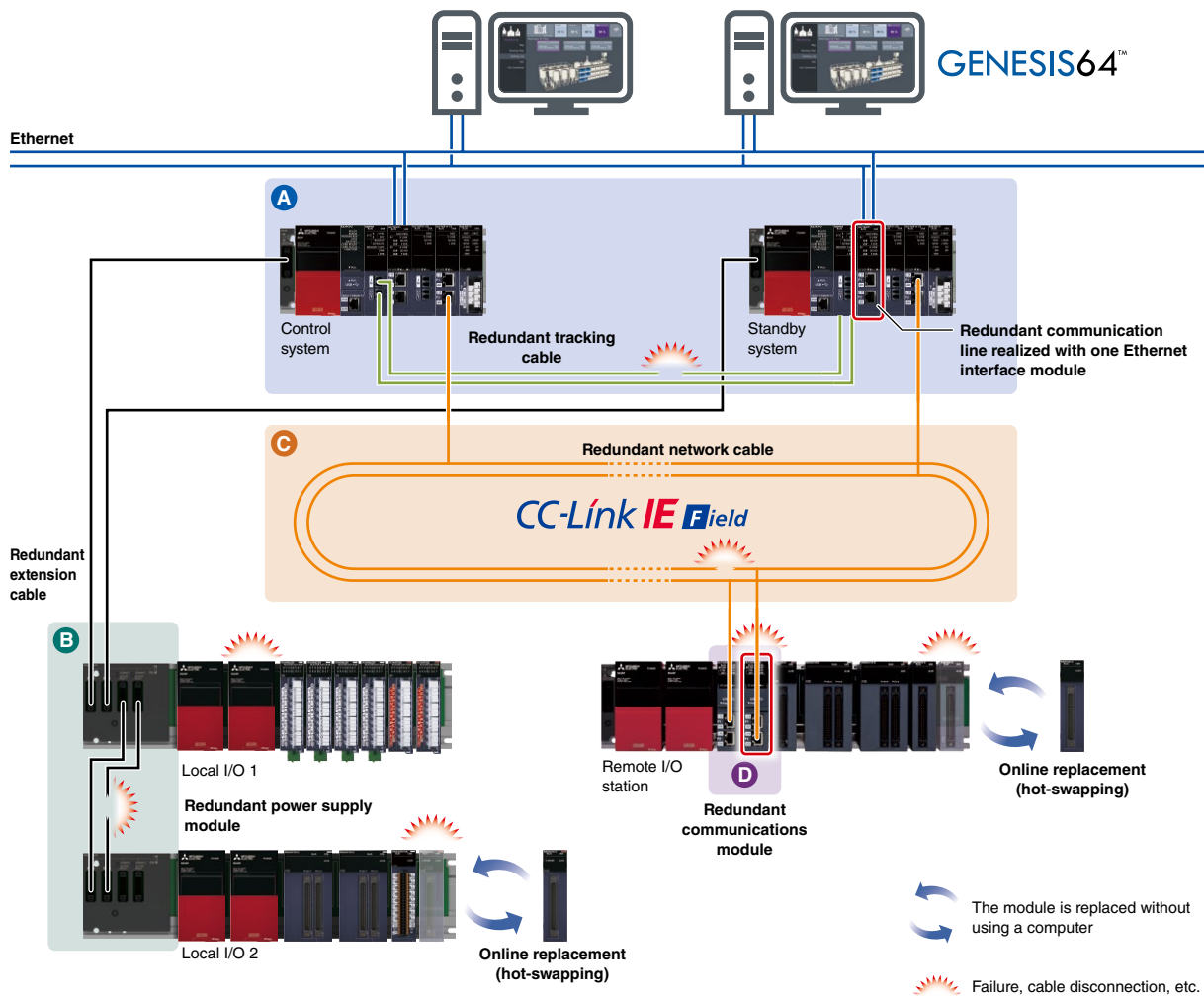

## Efficient engineering through extensive compatibility between software and devices

Efficient screen creation

Highly scalable system

Efficient engineering

- Screen creation is easier in an efficient engineering environment realized by the extensive compatibility between the engineering software GX Works3 together with SCADA software GENESIS64™, GT SoftGOT2000, and GOT2000
- Scalable SCADA control systems can be realized combining these products

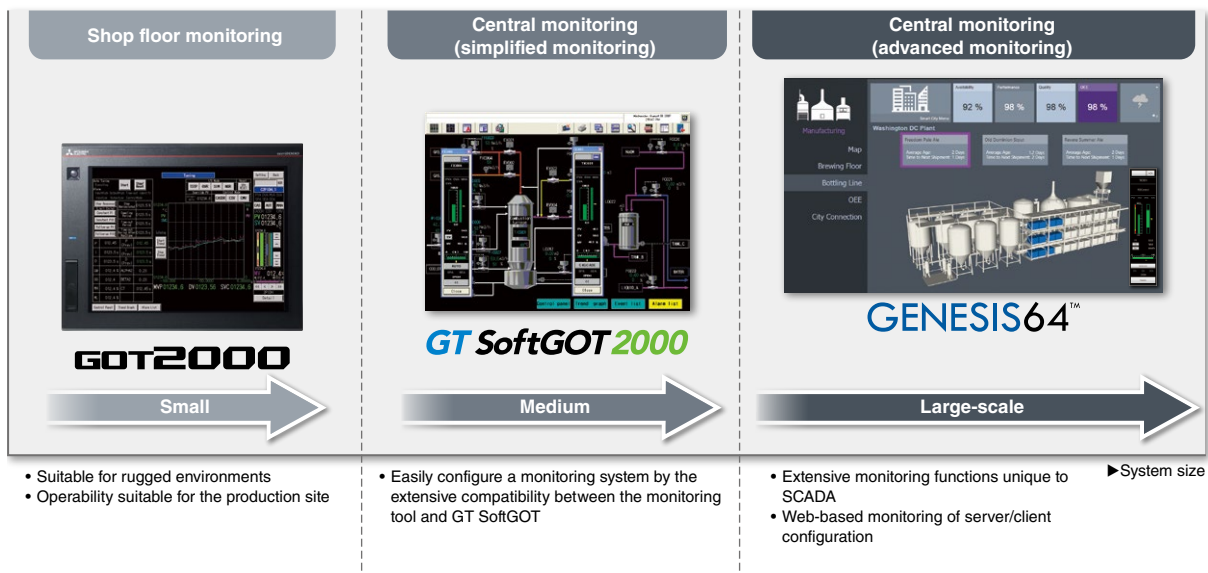

## Detect errors in connected devices and networks on each system

Diagnostics of both systems in the redundant system

Improved redundant system reliability

- An error in an external device or network of the systems (control system and standby system) can be detected by executing a program that diagnoses external devices or networks of both redundant systems.

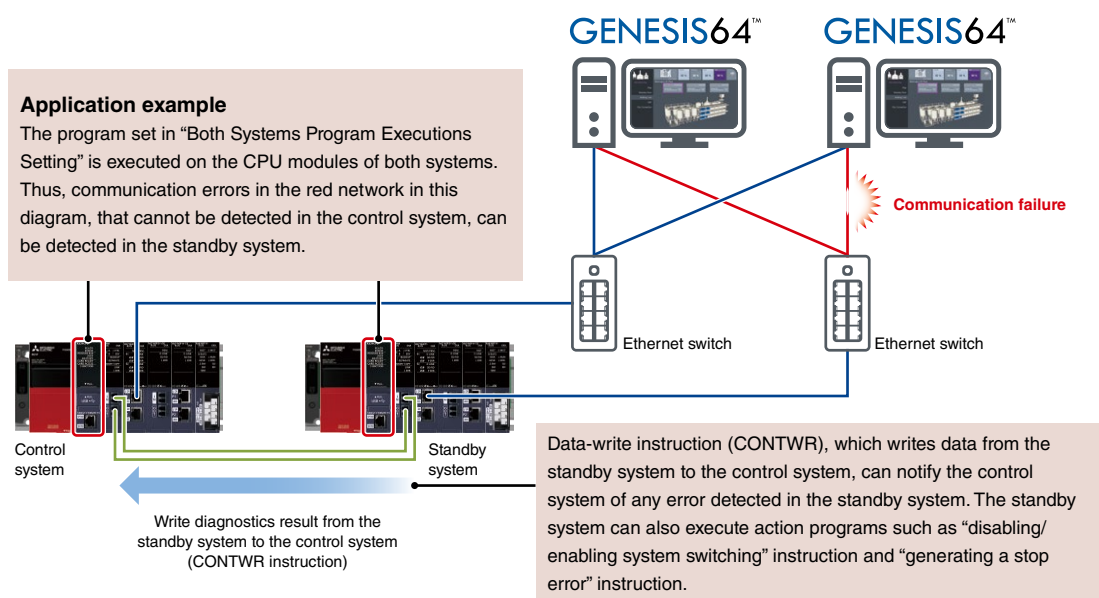

CPU

I/O

Analog/temperature input/temperature control

Motion/positioning

High-speed counter/ isolated pulse/ flexible high-speed I/O

FFGA

Network

Advanced information

Energy measuring

Software

Process CPU module/SIL2 process CPU module specifications

Item	LD : Ladder diagram		ST : Structured text		FBD : Function block diagram		SFC : Sequential function chart	
	R08PCPU	R16PCPU	R32PCPU	R120PCPU	R08PSFCPU -SET*1	R16PSFCPU -SET*1	R32PSFCPU -SET*1	R120PSFCPU -SET*1
Operation control method	Stored program cyclic operation							
I/O control mode	Refresh mode (Direct access I/O is available by specifying direct access I/O (DX, DY))							
Programming language	LD	ST	FBD	SFC	LD	ST	FBD	SFC
Extended programming language	Function block (FB), label programming (system/local/global)							
Program execution type	Initial*2, scan*2, fixed scan, event execution*2, standby*2							
Number of I/O points (X/Y)	4096	4096	4096	4096	4096	4096	4096	4096
Constant scan (ms) (function for keeping regular scan time)	0.2...2000 (setting available in 0.1 ms increments)							
Memory capacity								
Program capacity (step)	80K	160K	320K	1200K	80K (40K for safety programs)*3	160K (40K for safety programs)*3	320K (40K for safety programs)*3	1200K (40K for safety programs)*3
Program memory (byte)	320K	640K	1280K	4800K	320K	640K	1280K	4800K
Device/label memory (ECC type)*4 (byte)	1188K	1720K	2316K	3380K	1178K	1710K	2306K	3370K
Data memory (byte)	5M	10M	20M	40M	5M	10M	20M	40M
Instruction processing time								
LD instruction (ns)	0.98	0.98	0.98	0.98	0.98	0.98	0.98	0.98
MOV instruction (ns)	1.96	1.96	1.96	1.96	1.96	1.96	1.96	1.96
E + instruction (floating-point addition) (ns)	9.8	9.8	9.8	9.8	9.8	9.8	9.8	9.8
Structured text IF instruction*5 (ns)	1.96	1.96	1.96	1.96	1.96	1.96	1.96	1.96
Structured text FOR instruction*5 (ns)	1.96	1.96	1.96	1.96	1.96	1.96	1.96	1.96
PC MIX value*6 (instructions/μs)	419	419	419	419	419	419	419	419
Interface connection port								
High-speed USB2.0 (miniB)	●	●	●	●	●	●	●	●
Ethernet (100BASE-TX/10BASE-T)	●	●	●	●	●	●	●	●
Memory interface*7								
SD memory card	●	●	●	●	●	●	●	●
Extended SRAM cassette	●	●	●	●	●	●	●	●
Safety standard								
IEC 61508 SIL 2	-	-	-	-	●	●	●	●
Function*8								
Multiple interrupt	●	●	●	●	●	●	●	●
Standard PID control	●	●	●	●	●	●	●	●
Process control	●	●	●	●	●	●	●	●
Data logging	●	●	●	●	-	-	-	-
Security function	●	●	●	●	●	●	●	●
Inter-module synchronization*9	●	●	●	●	-	-	-	-
SLMP communication	●	●	●	●	●	●	●	●
Online module change	●	●	●	●	●	●	●	●
Simple CPU communication*10	●	●	●	●	-	-	-	-
Web server	●	●	●	●	-	-	-	-

\*1. Product package includes a SIL2 process CPU module (R□PSFCPU) and SIL2 function module (R6PSFM).  
 \*2. Cannot be used for safety control programs.  
 \*3. Up to 40K steps of the program capacity can be used for safety programs.  
 \*4. An extended SRAM cassette expands the device/label memory area. (N22MC-8MBSE expands the device/label memory area conforming to ECC type memory).  
 \*5. The IF or FOR sentence of the structured text consists of several instructions, which may increase the processing time period.  
 \*6. Average number of instructions such as for basic instructions and data processing executed in 1 μs. The larger the value, the faster the processing speed.  
 \*7. For more information, please refer to the SD memory card and SRAM cassette specifications on page 57.  
 \*8. Memory dump and real-time monitor are not supported.  
 \*9. Inter-module synchronization is not supported when used in redundant mode.  
 \*10. For the list of connectable devices supporting simple CPU communication function, please see the link below.  
[www.MitsubishiElectric.com/fa/ref/ref.html?k=plcr&pmerit=simple\\_cpu\\_com](http://www.MitsubishiElectric.com/fa/ref/ref.html?k=plcr&pmerit=simple_cpu_com)

Redundant function module specifications

Item	R6RFM
Connection cable	Multi-mode optical cable
Max. distance (m)	550 (when the core outer diameter is 50 μm)
Tracking cable data capacity (word)	1M

# C Controller module

## C intelligent function module

The C Controller and C intelligent function modules are open platform controllers that can execute C/C++ programs, based on the MELSEC system architecture, and utilize long-term stable supply, high availability, advanced functionality, and flexible features.

High-speed complex processing that is not possible with a ladder program is achieved while carrying out the MELSEC iQ-R Series module management and I/O control in C/C++ programs.

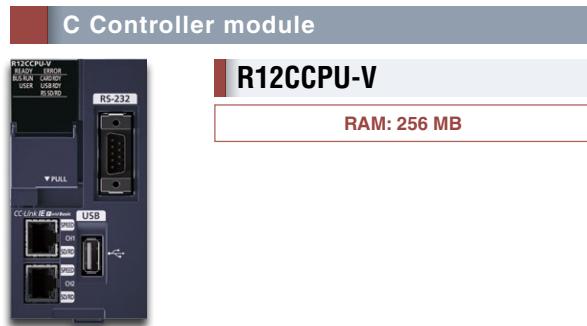

### Real-time control

Embedded with VxWorks®, the C Controller realizes real-time control which may not be possible with a general-purpose OS.

### High-speed processing

C language (C/C++) based programming realizes a high-speed processing.

### Easier system configuration

The module can be immediately utilized as the C Controller dedicated functions are pre-installed.

## Interface

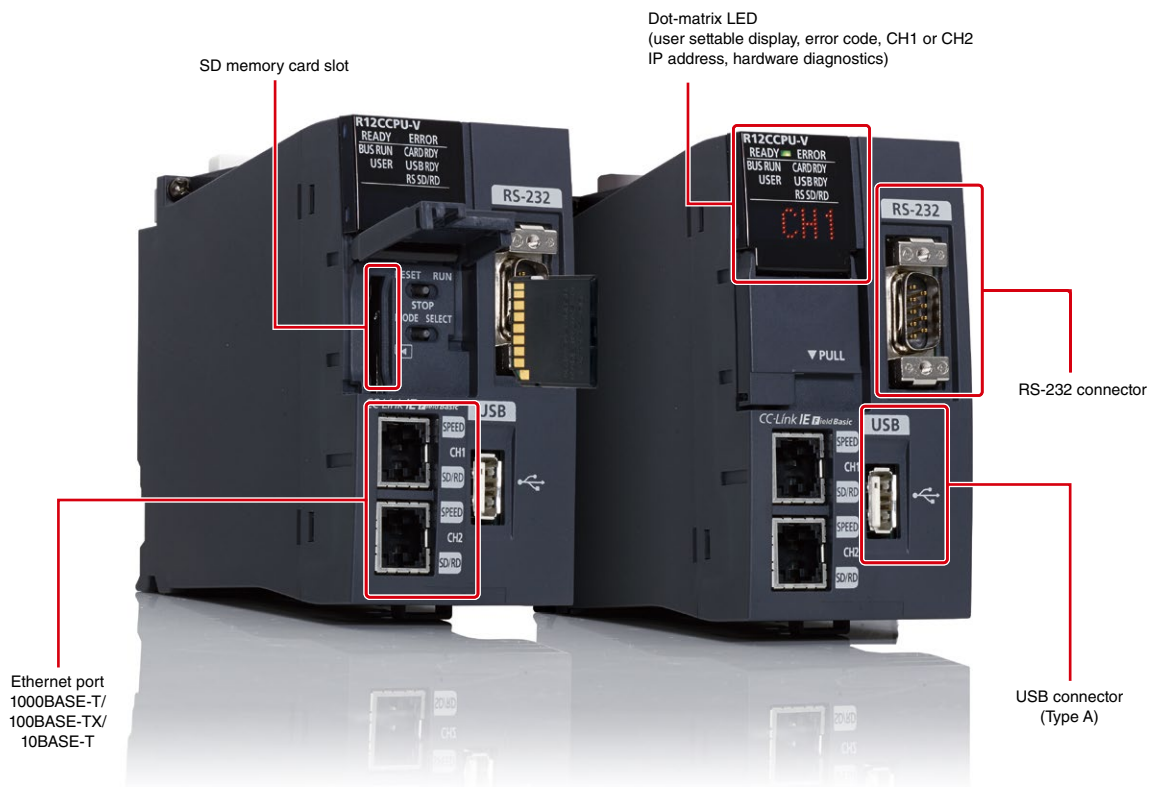

CPU
I/O
Analog/ temperature input/ temperature control
Motion/ positioning
High-speed counter/ isolated pulse/ flexible high-speed I/O
PLC
Network
Advanced Information
Energy measuring
Software

C intelligent function module



RD55UP06-V RD55UP12-V

**RD55UP06-V**

RAM: 128 MB

**RD55UP12-V**

RAM: 1 GB

**Distributed control with the CPU module**

Control processing is performed in the programmable controller CPU module and information processing in the C intelligent function module, reducing overall processing time.

**Extend functions of the existing facility**

Implementation of functions such as complex operations and protocol conversion according to the current system is possible.

**Multiple operating systems supported**

VxWorks® that improves data analysis accuracy is pre-installed and Linux® that executes Python® and such used for machine learning can be installed.\*1

\*1. This product is pre-installed with VxWorks®. As for Linux®, OS images need to be downloaded separately.

**Interface**

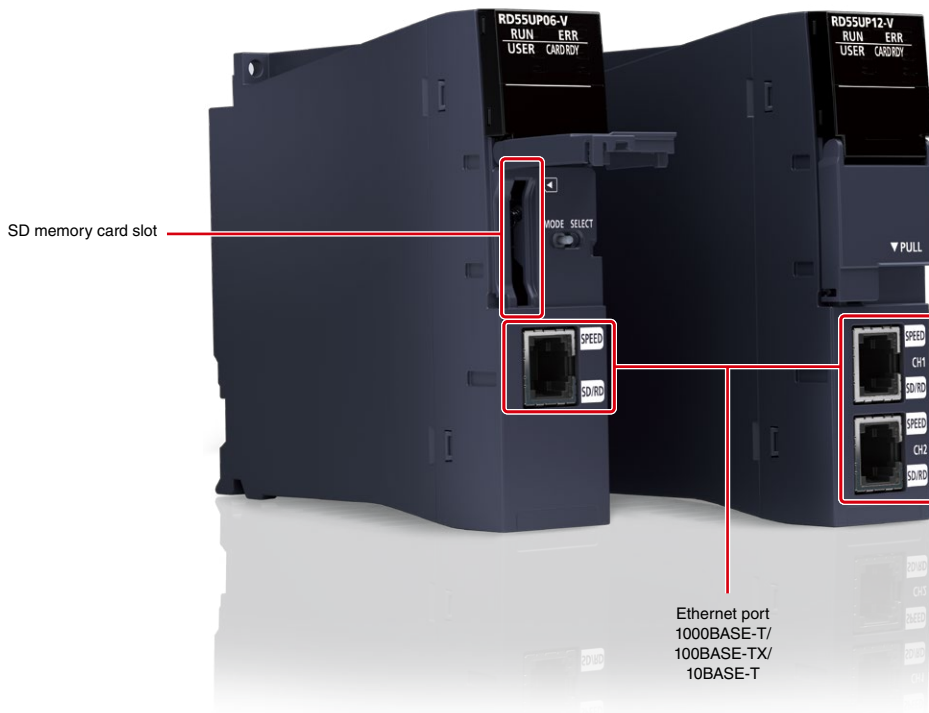

SD memory card slot

Ethernet port  
1000BASE-T/  
100BASE-TX/  
10BASE-T

### Troublesome information processing is easy in C/C++

C/C++ program

Easy programming

Intelligent protection

- Troublesome information processing (complex arithmetic and string processing) is much easier in C/C++ programs than implementing in ladder form
- Intellectual property is simplified by separating it from the ladder program using C Controller module or C intelligent function module, preventing leakage of proprietary technology

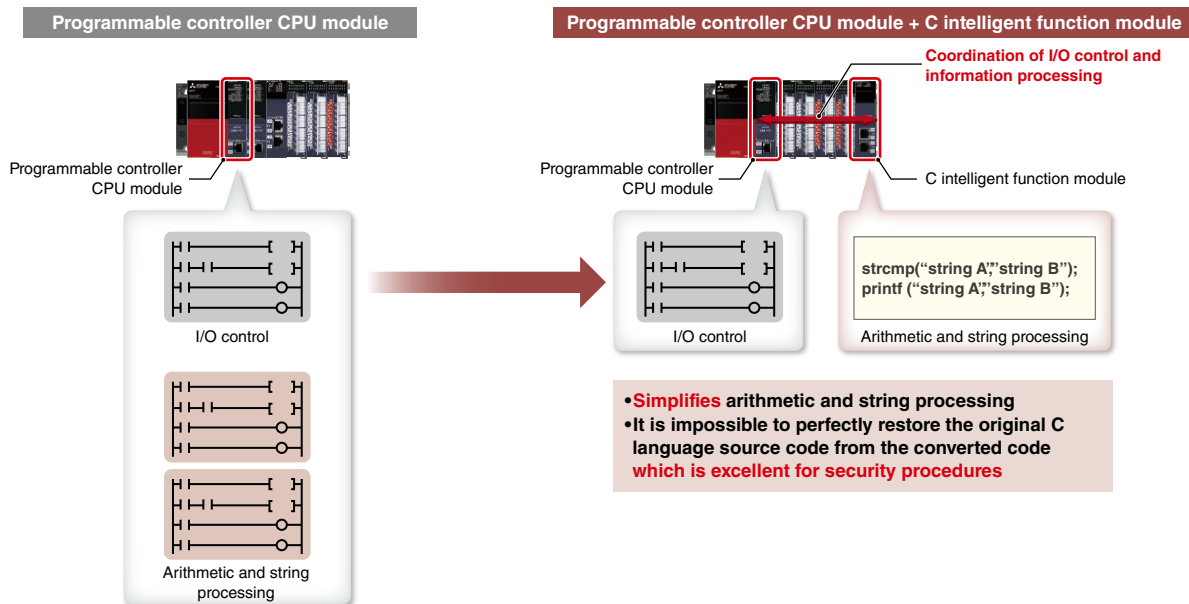

### Easier development utilizing dedicated functions and partner applications

Dedicated functions and libraries

Partner applications

Debian GNU/Linux

- Easily access to modules using dedicated functions and communication libraries. In addition, by utilizing partner applications supporting different manufacturing equipment features, various systems can be configured
- The C intelligent function module utilizes Debian GNU/Linux allowing machines to utilize the latest data processing technology developed by the community, helping to reduce development time
- Key features such as remote operation, predictive maintenance, and remote maintenance of machines can be easily implemented in the C intelligent function module through connection with third-party cloud services

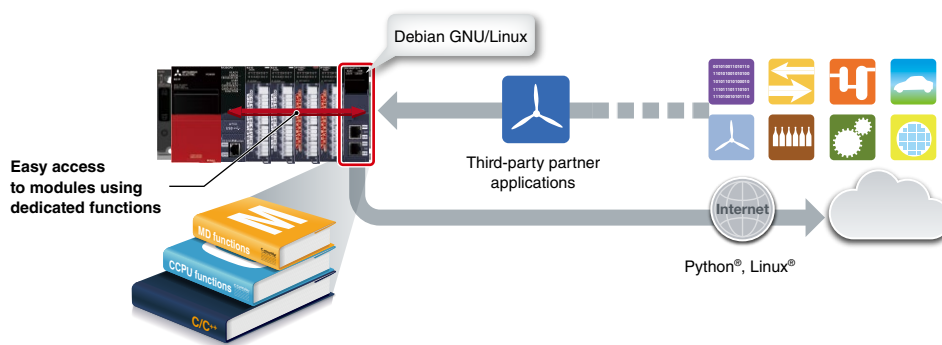

CPU

I/O

Analog/  
temperature input/  
temperature control

Motion/  
positioning

High-speed counter/  
isolated pulse/  
flexible high-speed I/O

FPGA

Network

Advanced  
information

Energy  
measuring

Software

**Easy parameter setup, diagnostics, monitoring and test in the dedicated development environment**

R12CCPU-V

Easy setup

Easy diagnostics

- CW Configurator enables parameter setup, module diagnostics, monitoring, and test of various MELSEC iQ-R/Q Series modules including the C Controller module
- Using CW Configurator is as easy as using the engineering software GX Works3, which shares similar interfaces

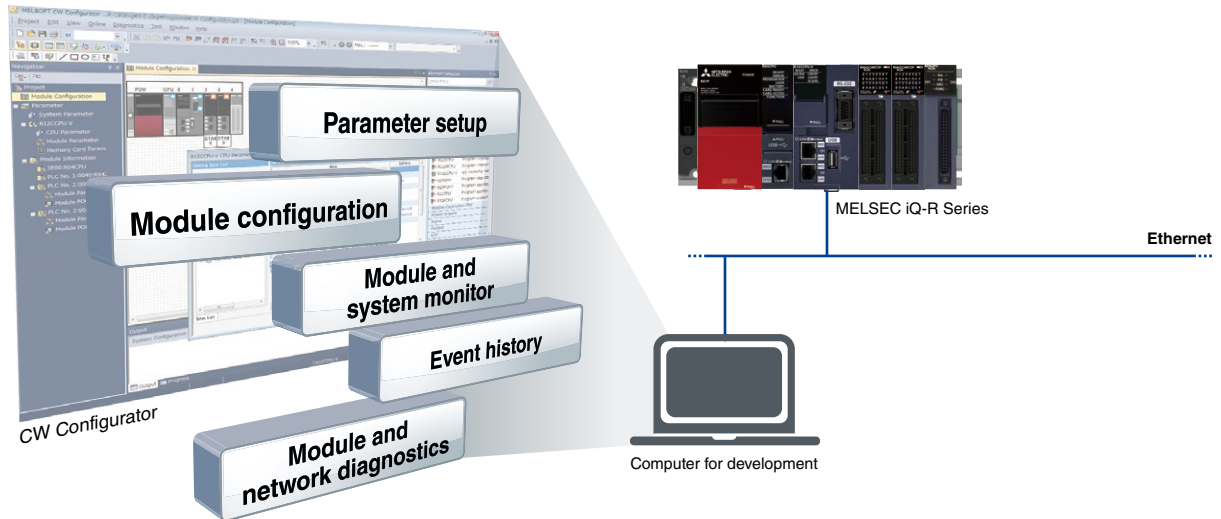

**Application development in simple steps**

Easy programming

Simulation without hardware

- Developing applications with the C Controller module is easy as no additional driver development is required, thereby providing a full-scale embedded development environment at a relatively low cost
- CW Workbench enables programming in C/C++
- CW-Sim/CW-Sim Standalone allows simulation of VxWorks® without requiring any hardware

**No need to generate OS or drivers.  
This program does it all.**

The screenshot shows the CW Workbench development environment. The main window displays a C program for inter-module synchronization. The code includes comments in Japanese and C++ style comments explaining the purpose of the interrupt routine and the data read/write operations.

```

void myFunc0 {
    /* Enter an interrupt routine for the inter-module synchronization interruption (144) */
    CPU_EntryInt( 44, myISR44 );

    /* Enable the routine entered to the inter-module synchronization interruption (144) */

    /* operation to be executed for the inter-module synchronization
    intelligent function module (I/O No. : 0x20, offset: 100, size: 8 words)
    100, 8, (unsigned short*)&DataRead[0] );
    /*
    /* operation data */
    100, 8, (unsigned short*)&DataWrite, 0 );
    */
}
    
```

The interface also shows a project tree on the left and a simulation status window on the right.

CW Workbench



**C Controller module specifications**

Item	R12CCPU-V
<b>Hardware</b>	
MPU	Arm® Cortex®-A9 Dual Core
RAM (byte)	256M
ROM (byte)	16M
Backup RAM (byte)	4096K (file storage area of device/label memory: 3584 KB, for system: 512 KB)
<b>Software</b>	
OS	VxWorks® Version 6.9*1
Programming language	C/C++
Programming development environment	CW Workbench/Wind River® Workbench 3.3*1
C Controller module setting/monitoring tool	CW Configurator (SW1DND-RCCPU)
<b>Communication interface</b>	
USB	●
Ethernet (1000BASE-T/100BASE-TX/10BASE-T) (ch)	2
RS-232 (9600...115200 bps) (ch)	1
SD memory card slot	●

\*1. VxWorks® 6.9 and Wind River® Workbench 3.3 are products of Wind River Systems, Inc. in the United States. For any inquiries on products of Wind River Systems, Inc. in the United States, please refer to the manuals of Wind River Systems products or contact Wind River Systems, Inc. in Japan. Please visit the website below.  
[www.windriver.com](http://www.windriver.com)

**C intelligent function module specifications**

Item	RD55UP06-V	RD55UP12-V
<b>Hardware</b>		
MPU	Arm® Cortex®-A9 Dual Core	
RAM (byte)	128M	1G
ROM (byte)	12M	
<b>Software</b>		
OS	VxWorks® Version 6.9 (installed by default)*2/ Debian GNU/Linux	
Programming language	C/C++	
Programming development environment	VxWorks® Version 6.9	CW Workbench/Wind River® Workbench 3.3*2
	Debian GNU/Linux	
Setting/monitoring tool	TimeStorm®/Visual Studio® GX Works3 (SW1DND-GXW3-E)*3	
<b>Communication interface</b>		
Ethernet (1000BASE-T/100BASE-TX/10BASE-T) (ch)	1	2
SD memory card slot	●	

\*2. VxWorks® 6.9 and Wind River® Workbench 3.3 are products of Wind River Systems, Inc. in the United States. For any inquiries on products of Wind River Systems, Inc. in the United States, please refer to the manuals of Wind River Systems products or contact Wind River Systems, Inc. in Japan. Please visit the website below.  
[www.windriver.com](http://www.windriver.com)

\*3. Setting and monitoring of the module is integrated within the engineering software GX Works3.

CPU

I/O

Analog/temperature input/temperature control

Motion/positioning

High-speed counter/ isolated pulse/ flexible high-speed I/O

FPGA

Network

Advanced information

Energy measuring

Software

## MELSECWinCPU Module

The MELSECWinCPU module executes Windows® applications and realizes data coordination with other CPU modules and I/O modules easily. Equipped with robust features, the module offers a stable computer-based system even in a harsh environment. A fan-less hardware design enables natural cooling operation, eliminating the risk of operation stop due to a fan failure.



**R102WCPU-W**

### A wide selection of interfaces

#### General interface

- Equipped with interfaces similar to a computer, the system can be easily configured with widely available devices
- Built-in USB ports, two Ethernet ports, RS-232, and HDMI are available, also with CFast™ card and SD memory card for storage are supported

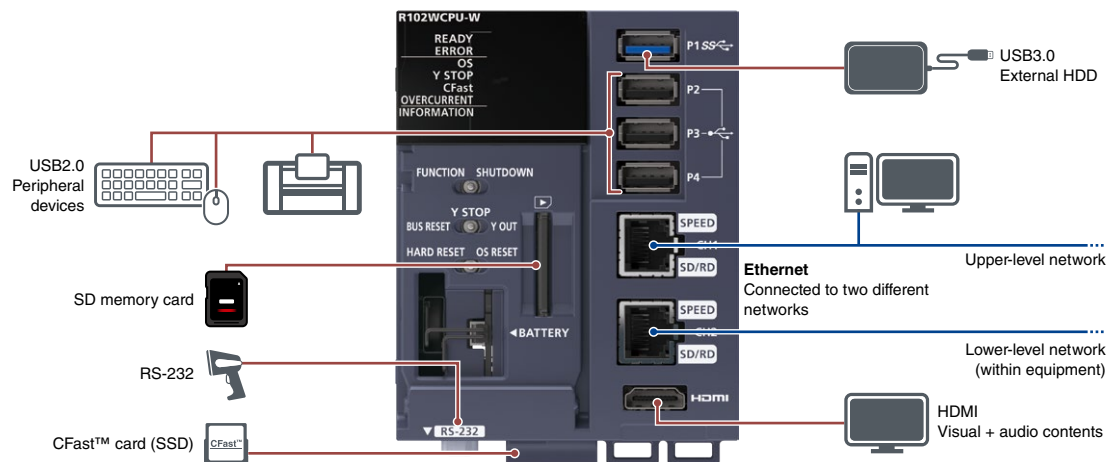

### Information processing utilizing Windows®

#### Utilization of Windows®

#### Multiple CPU configuration

#### Utilization of development assets

- Utilizing the familiar Windows® assets in the office, information processing such as control data calculation/processing and data exchange with a computer are possible
- The module, which is incorporated into the multiple CPU configuration, can easily add functions utilizing Windows® to the existing equipment
- Easy-to-understand development environment such as Microsoft® Visual Basic® and Visual C#® as well as existing development assets can be utilized

**IT system is easily configured utilizing pre-installed functions**

Easy IT system configuration

- The IT system on the production site can be configured using Microsoft® Visual Studio® development environment
- The MELSECWinCPU module can easily communicate with the programmable controller system by using pre-installed functions (C Controller module dedicated functions and MELSEC communication functions)
- A computer is no longer necessary in the production site, therefore eliminating any issues of LAN installation

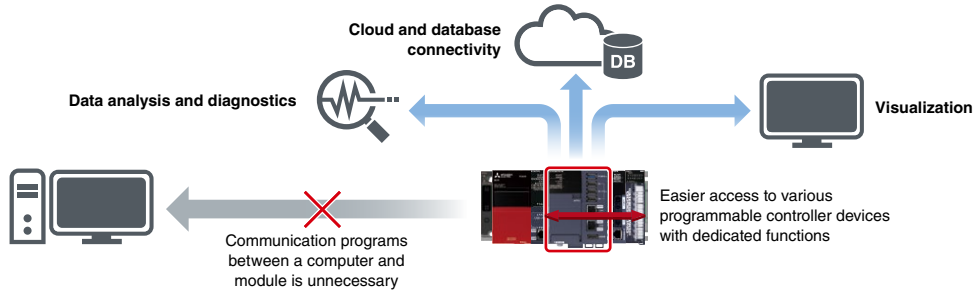

**On-site development reduces risk of data breach**

Robust security

- Due to growing security concern, it is becoming increasingly difficult to bring computers to the production site. The MELSECWinCPU module is an excellent alternative to a computer
- Installing the MELSECWinCPU module in the control panel can reduce the risk of technology and data theft as well as virus invasion
- When the engineering software is installed and a keyboard, mouse and display are connected, urgent maintenance is easily handled



**MELSECWinCPU module specifications**

Item	R102WCPU-W
<b>Hardware</b>	
MPU	Intel Atom® E3930 Dual Core
Main memory (byte)	4G
Internal storage (CFast™) (byte)	60G
<b>Software</b>	
OS	Windows® 10 IoT Enterprise LTSC 2019
Programming language	C/C++, Visual Basic®, C#
<b>Communication interface</b>	
Extension SSD	CFast™ (SATA III) (1x)
USB	USB3.0 (1x)/USB2.0 (3x)
Ethernet	1000BASE-T/100BASE-TX/10BASE-T (2x)
SD memory card	SDHC High Speed (1x)
<b>Display</b>	
Interface	HDMI 1.4b (1x)

CPU

I/O

Analog/temperature input/temperature control

Motion/positioning

High-speed counter/ isolated pulse/ flexible high-speed I/O

FPGA

Network

Advanced information

Energy measuring

Software

## I/O module

Digital I/O modules are the senses of the automation system and provide an interface of various processes to the controller. Devices such as switches, indicator lamps, and sensors can be easily connected to the control system. The MELSEC iQ-R Series I/O modules have enhanced functions compared with the existing Series, one module can support various applications, reducing implementation and maintenance costs.

Modules can be selected according to requirements such as ease of wiring, number of points and characteristics of devices to be connected.

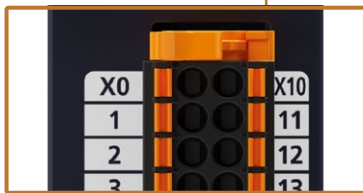

### Spring-clamp terminal block

- Easy wiring by simply inserting a cable
- Maintenance is easy as no retightening required
- Various tests on connection are conducted, I/O modules can be used without having to worry about loosening



### 40-pin connector

- Pre-made harnesses can be attached to the module, eliminating on-site wiring
- Convenient for wiring to an external relay terminal block
- Ideal for mass-production equipment



### Screw terminal block

- As general crimp terminals are used, wiring can be done in a conventional method
- Continuity can be checked one by one, ensuring reliable wiring
- Replaceable with a spring-clamp terminal block
- Useful when fabrication or modification work is anticipated

+: Positive common - : Negative common +/-: Positive/negative common shared

## DC input

### 24 V DC



RX40C7-TS



RX40C7



RX41C4-TS



RX41C4



RX42C4

#### RX40C7-TS

Spring-clamp terminal block

16 points

+/-

#### RX41C4-TS

Spring-clamp terminal block

32 points

+/-

#### RX40C7

Screw terminal block

16 points

+/-

#### RX41C4

40-pin connector

32 points

+/-

#### RX42C4

40-pin connector (2x)

64 points

+/-

### 5/12 V DC



RX70C4

#### RX70C4

Screw terminal block

16 points

+/-

#### RX71C4

40-pin connector

32 points

+/-

#### RX72C4

40-pin connector (2x)

64 points

+/-

### High-speed 24 V DC



RX41C6HS

#### RX40PC6H

Screw terminal block

16 points

+

#### RX40NC6H

Screw terminal block

16 points

-

#### RX41C6HS

40-pin connector

32 points

+/-

### High-speed 5 V DC



#### RX61C6HS

40-pin connector

32 points

+/-

### Diagnostic functions 24 V DC



#### RX40NC6B

Screw terminal block

16 points

-

### Safety functions 24 V DC

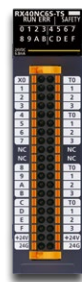

#### RX40NC6S-TS **NEW**

Spring-clamp terminal block

Single wiring: 16 points; Double wiring: 8 points

-

CPU

I/O

Analog/  
temperature input/  
temperature control

Motion/  
positioning

High-speed counter/  
isolated pulse/  
flexible high-speed I/O

FPGA

Network

Advanced  
information

Energy  
measuring

Software

## AC input

100 to 240 V AC



**RX28**  
Screw terminal block

8 points

100 to 120 V AC



**RX10-TS**  
Spring-clamp terminal block

16 points

**RX10**  
Screw terminal block

16 points

RX10

## Transistor output

Sink type 12/24 V DC, 0.5 A/point



**RY40NT5P-TS**  
Spring-clamp terminal block

16 points

**RY40NT5P**  
Screw terminal block

16 points

RY40NT5P

Sink type 12/24 V DC, 0.2 A/point



**RY41NT2P-TS**  
Spring-clamp terminal block

32 points

**RY41NT2P**  
40-pin connector

32 points

**RY42NT2P**  
40-pin connector (2x)

64 points

RY42NT2P

Source type 12/24 V DC, 0.5 A/point



**RY40PT5P-TS**  
Spring-clamp terminal block

16 points

**RY40PT5P**  
Screw terminal block

16 points

RY40PT5P

Source type 12/24 V DC, 0.1 A/point



**RY41PT1P-TS**  
Spring-clamp terminal block

32 points

**RY41PT1P**  
40-pin connector

32 points

**RY42PT1P**  
40-pin connector (2x)

64 points

RY42PT1P

High-speed, sink type  
5/12/24 V DC, 0.2 A/point



**RY41NT2H**  
40-pin connector

32 points

High-speed, source type  
5/12/24 V DC, 0.2 A/point



**RY41PT2H**  
40-pin connector

32 points

+/-: Positive/negative common shared

**Diagnostic functions, source type**  
24 V DC, 0.5 A/point



**RY40PT5B**  
Screw terminal block

16 points

**Safety functions, source type**  
24 V DC, 2 A/point



**RY48PT20S-TS** **NEW**  
Spring-clamp terminal block

Single wiring: 8 points  
Double wiring: 4 points

**Relay output**

24 V DC 2 A/point, 240 V AC 2 A/point



**RY18R2A**  
Screw terminal block

8 points

**RY10R2-TS**  
Spring-clamp terminal block

16 points

**RY10R2**  
Screw terminal block

16 points

RY10R2

**Triac output**

100 to 240 V AC, 0.6 A/point



**RY20S6**  
Screw terminal block

16 points

**DC input, transistor output**

24 V DC  
Sink type 12/24 V DC, 0.2 A/point



**RH42C4NT2P**  
40-pin connector (2x)

32 points

+/-

CPU	
I/O	
Analog/ temperature input/ temperature control	
Motion/ positioning	
High-speed counter/ isolated pulse/ flexible high-speed I/O	
FFGA	
Network	
Advanced information	
Energy measuring	
Software	

## Response speed setting preventing unintended signal input

Input

Setting in 1-point increments

Prevent unintended input

- The response time of the input module can be changed from the engineering software GX Works3 in 1-point increments depending on the quality of the incoming signal
- The setting reference for input response time is explained below
  - For unstable signals such as relay contacts and switches, set a longer response time to stabilize the signals
  - For stable signals such as transistor outputs, set a shorter response time to enable high-speed inputs

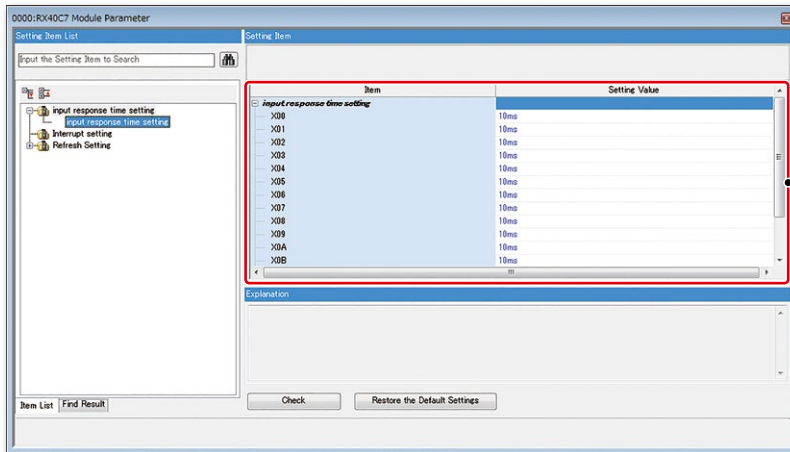

Response time of the input module can be set in 1-point increments

## Cable disconnection/short-circuit detection using diagnostic functions

RX40NC6B

RY40PT5B

Disconnection detection

Output short-circuit detection

- Cable disconnections can be detected by either the “input disconnection detection function” or “output disconnection detection function”
- Output overcurrent due to short circuit can be detected by the “output short-circuit detection function”
- “Output disconnection detection disable time setting” disables the disconnection detection function for a predetermined period of time after the turning on of the output. This reduces the false disconnection detection because the result of detection is not affected by the back EMF just after the output

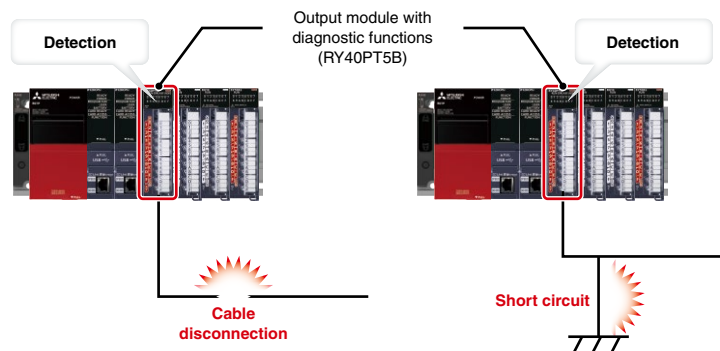

## Relay health diagnostics for preventive maintenance

RY18R2A

RY10R2-TS

RY10R2

RY40PT5B

Preventive maintenance

- Utilizing data, such as from embedded relay contacts in the relay output module or from relays connected externally to the transistor output module (with diagnostic functions), preventive maintenance can be carried out based on the known service of the relay



Input module specifications

Item	DC input							
	RX40C7-TS	RX40C7	RX41C4-TS	RX41C4	RX42C4	RX70C4	RX71C4	RX72C4
Number of input points	16	16	32	32	64	16	32	64
Rated input voltage (V DC)	24	24	24	24	24	5/12	5/12	5/12
Input current (TYP.) (mA)	7.0	7.0	4.0	4.0	4.0	1.7 (5 V DC) 4.8 (12 V DC)	1.7 (5 V DC) 4.8 (12 V DC)	1.7 (5 V DC) 4.8 (12 V DC)
Response time (ms)	0.1...70	0.1...70	0.1...70	0.1...70	0.1...70	0.2...70	0.2...70	0.2...70
Common terminal arrangement (points/common)	16 (positive/negative common shared)	16 (positive/negative common shared)	32 (positive/negative common shared)	32 (positive/negative common shared)	32 (positive/negative common shared)	16 (positive/negative common shared)	32 (positive/negative common shared)	32 (positive/negative common shared)
Interrupt function	●	●	●	●	●	●	●	●
External interface*1								
Spring-clamp terminal block	●	-	●	-	-	-	-	-
18-point screw terminal block	-	●	-	-	-	●	-	-
40-pin connector	-	-	-	●	● (2x)	-	●	● (2x)

\*1. For more information about external interface, please refer to the options list on page 156. (for applicable options, please refer to the relevant product manual).

Item	DC high-speed input				DC input with diagnostic functions
	RX40PC6H	RX40NC6H	RX41C6HS	RX61C6HS	RX40NC6B
Number of input points	16	16	32	32	16
Rated input voltage (V DC)	24	24	24	5	24
Input current (TYP.) (mA)	6.0	6.0	6.0	6.0	6.0
Response time	5 μs...70 ms	5 μs...70 ms	1 μs...70 ms	1 μs...70 ms	1 μs...70 ms
Common terminal arrangement (points/common)	8 (positive common)	8 (negative common)	32 (positive/negative common shared)	32 (positive/negative common shared)	16 (negative common)
Interrupt function	●	●	●	●	●
SIL2 mode	-	-	-	-	●*2
Diagnostic function					
Input disconnection detection	-	-	-	-	●
External interface*3					
18-point screw terminal block	●	●	-	-	●
40-pin connector	-	-	●	●	-

\*2. Used when the SIL 2-supporting redundant system is configured.

\*3. For more information about external interface, please refer to the options list on page 156. (for applicable options, please refer to the relevant product manual).

Item	DC input with safety functions	
	RX40NC6S-TS <b>NEW</b>	
Safety integrity level (SIL)	SIL 3 (EN 61508)	
Performance level (PL)	PL e (EN ISO 13849-1)	
Number of input points	Single wiring: 16 Double wiring: 8	
Rated input voltage (V DC)	24	
Input current (TYP.) (mA)	6.8	
Response time (ms)	1...70	
Common terminal arrangement (points/common)	16 (negative common)	
Function		
Input dark test	●	
Double input discrepancy detection	●	
External interface*4		
Spring-clamp terminal block	●	

\*4. For more information about external interface, please refer to the options list on page 156. (for applicable options, please refer to the relevant product manuals).

Item	AC input		
	RX28	RX10-TS	RX10
Number of input points	8	16	16
Rated input voltage, frequency	100...240 V AC, 50/60 Hz	100...120 V AC, 50/60 Hz	100...120 V AC, 50/60 Hz
Input current (RMS.TYP.) (mA)	16.4 (200 V AC, 60 Hz) 13.7 (200 V AC, 50 Hz) 8.2 (100 V AC, 60 Hz) 6.8 (100 V AC, 50 Hz)	8.2 (100 V AC, 60 Hz) 6.8 (100 V AC, 50 Hz)	8.2 (100 V AC, 60 Hz) 6.8 (100 V AC, 50 Hz)
Response time (ms)	≤ 20	≤ 20	≤ 20
Common terminal arrangement (points/common)	8	16	16
Interrupt function	●	●	●
External interface*5			
Spring-clamp terminal block	-	●	-
18-point screw terminal block	●	-	●

\*5. For more information about external interface, please refer to the options list on page 156. (for applicable options, please refer to the relevant product manual).

CPU

I/O

Analog/temperature input/temperature control

Motion/positioning

High-speed counter/ isolated pulse/ flexible high-speed I/O

FFGA

Network

Advanced information

Energy measuring

Software

## Output module specifications

Item	Transistor output					
	RY40NT5P-TS	RY40NT5P	RY41NT2P-TS	RY41NT2P	RY42NT2P	RY40PT5P-TS
Output type	Sink	Sink	Sink	Sink	Sink	Source
Number of output points	16	16	32	32	64	16
Rated load voltage (V DC)	12/24	12/24	12/24	12/24	12/24	12/24
Max. load current	0.5 A/point, 5 A/common	0.5 A/point, 5 A/common	0.2 A/point, 2 A/common	0.2 A/point, 2 A/common	0.2 A/point, 2 A/common	0.5 A/point, 5 A/common
Response time (ms)	≤ 1	≤ 1	≤ 1	≤ 1	≤ 1	≤ 1
Common terminal arrangement (points/common)	16	16	32	32	32	16
Protection function (overload, overheat)	●	●	●	●	●	●
External interface*1						
Spring-clamp terminal block	●	-	●	-	-	●
18-point screw terminal block	-	●	-	-	-	-
40-pin connector	-	-	-	●	● (2x)	-

\*1. For more information about external interface, please refer to the options list on page 156. (for applicable options, please refer to the relevant product manual).

Item	Transistor output				Transistor high-speed output		Transistor output with diagnostic functions
	RY40PT5P	RY41PT1P-TS	RY41PT1P	RY42PT1P	RY41NT2H	RY41PT2H	
Output type	Source	Source	Source	Source	Sink	Source	Source
Number of output points	16	32	32	64	32	32	16
Rated load voltage (V DC)	12/24	12/24	12/24	12/24	5/12/24	5/12/24	24
Max. load current	0.5 A/point, 5 A/common	0.1 A/point, 2 A/common	0.1 A/point, 2 A/common	0.1 A/point, 2 A/common	0.2 A/point, 2 A/common	0.2 A/point, 2 A/common	0.5 A/point, 5 A/common
Response time	≤ 1 ms	≤ 1 ms	≤ 1 ms	≤ 1 ms	≤ 2 μs	≤ 2 μs	≤ 1.5 ms
Common terminal arrangement (points/common)	16	32	32	32	32	32	16
Protection function (overload, overheat)	●	●	●	●	-	-	●
SIL2 mode	-	-	-	-	-	-	●*2
Diagnostic function							
Output disconnection detection	-	-	-	-	-	-	●
Output short-circuit detection	-	-	-	-	-	-	●
External interface*3							
Spring-clamp terminal block	-	●	-	-	-	-	-
18-point screw terminal block	●	-	-	-	-	-	●
40-pin connector	-	-	●	● (2x)	●	●	-

\*2. Used when the SIL 2-supporting redundant system is configured.

\*3. For more information about external interface, please refer to the options list on page 156. (for applicable options, please refer to the relevant product manual).

Item	Transistor output with safety functions	
	RY48PT20S-TS <b>NEW</b>	
Safety integrity level (SIL)	SIL 3 (EN 61508)	
Performance level (PL)	PL e (EN ISO 13849-1)	
Output type	Source	
Number of output points	Single wiring: 8; Double wiring: 4	
Rated load voltage (V DC)	24	
Max. load current	2 A/point, 16 A/common	
Response time	≤ 0.4 ms	
Common terminal arrangement (points/common)	8	
Function		
Output dark test	●	
Output readback	●	
External interface*4		
Spring-clamp terminal block	●	

\*4. For more information about external interface, please refer to the options list on page 156. (for applicable options, please refer to the relevant product manuals).

Item	Relay output			Triac output
	RY18R2A	RY10R2-TS	RY10R2	RY20S6
Number of output points	8	16	16	16
Rated switching voltage, current	24 V DC 2 A/point 240 V AC 2 A/point	24 V DC 2 A/point 240 V AC 2 A/point	24 V DC 2 A/point 240 V AC 2 A/point	100...240 V AC, 0.6 A/point*5
Response time	≤ 12 ms	≤ 12 ms	≤ 12 ms	≤ 1 ms + 0.5 cycle
Common terminal arrangement (points/common)	- (all points independent contact)	16	16	16
External interface*6				
Spring-clamp terminal block	-	●	-	-
18-point screw terminal block	●	-	●	●

\*5. Rated load voltage and maximum load current values

\*6. For more information about external interface, please refer to the options list on page 156. (for applicable options, please refer to the relevant product manual).

**I/O combined module specifications**

Item	RH42C4NT2P
<b>DC input</b>	
Number of input points	32
Rated input voltage (V DC)	24
Input current (TYP.) (mA)	4.0
Response time (ms)	0.1...70
Common terminal arrangement (points/common)	32 (positive/negative common shared)
Interrupt function	●
<b>Transistor output</b>	
Output type	Sink
Number of output points	32
Rated load voltage (V DC)	12/24
Max. load current	0.2 A/point, 2 A/common
Response time (ms)	≤ 1
Common terminal arrangement (points/common)	32
Protection function (overload, overheat)	●
<b>External interface*1</b>	
40-pin connector	● (2x)

\*1. For more information about external interface, please refer to the options list on page 156. (for applicable options, please refer to the relevant product manual).

CPU

I/O

Analog/ temperature input/ temperature control

Motion/ positioning

High-speed counter/ isolated pulse/ flexible high-speed I/O

FPGA

Network

Advanced information

Energy measuring

Software

## Analog module

Similar to the digital I/O modules, analog modules are the main interface between various analog devices and the programmable controller. Analog input modules process analog signals from external devices and analog output modules output analog signals are available.

### Analog input module

#### Without channel isolated



R60AD4



R60AD18-HA

<b>R60AD4</b> Screw terminal block		<b>R60AD18</b> Screw terminal block		<b>R60AD18-HA</b> Spring-clamp terminal block	
Voltage/current	4-channel	Current	8-channel	Current	8-channel
<b>R60ADV8</b> Screw terminal block		<b>R60ADH4</b> Screw terminal block		<b>HART® communication</b>	
Voltage	8-channel	Voltage/current	4-channel		
High-speed conversion 1 μs/channel					

#### With channel isolated



R60AD8-G



R60AD16-G

<b>R60AD8-G</b> 40-pin connector		<b>R60AD6-DG</b> 40-pin connector	
Voltage/current	8-channel	Current	6-channel
<b>R60AD16-G</b> 40-pin connector (2x)			
Voltage/current	16-channel		

### Analog output module

#### Without channel isolated



R60DA18

<b>R60DA4</b> Screw terminal block		<b>R60DA18</b> Screw terminal block			
Voltage/current	4-channel	Current	8-channel		
<b>R60DAV8</b> Screw terminal block		<b>R60DAH4</b> Screw terminal block			
Voltage	8-channel	Voltage/current	4-channel		
High-speed conversion 1 μs/channel					

#### With channel isolated



R60DA8-G



R60DA16-G

<b>R60DA8-G</b> 40-pin connector	
Voltage/current	8-channel
<b>R60DA16-G</b> 40-pin connector (2x)	
Voltage/current	16-channel

### Scaling and shifting digital values without any programs

Input  
Output

No programming

Development cost reduction

Program size reduction

- Scaling and shifting can be easily setup from only using the parameters. There is no need for additional programming
- Engineering costs and overall program size can be reduced

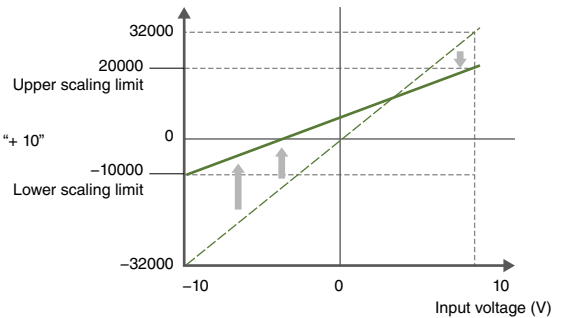
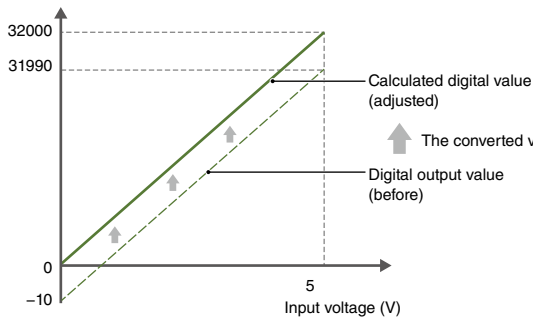

Upper and lower limits of scaling can range from -32000 to 32000.

### Galvanic channel isolation prevents electric disturbances such as current and noise

Input  
Output

Prevention of current and noise interference

Low-cost system configuration

- Channel isolated analog modules protect the internal module components from a short circuit (without requiring an additional signal converter) and therefore can configure a compact system at a low cost

#### Electric disturbances such as current and noise can be isolated

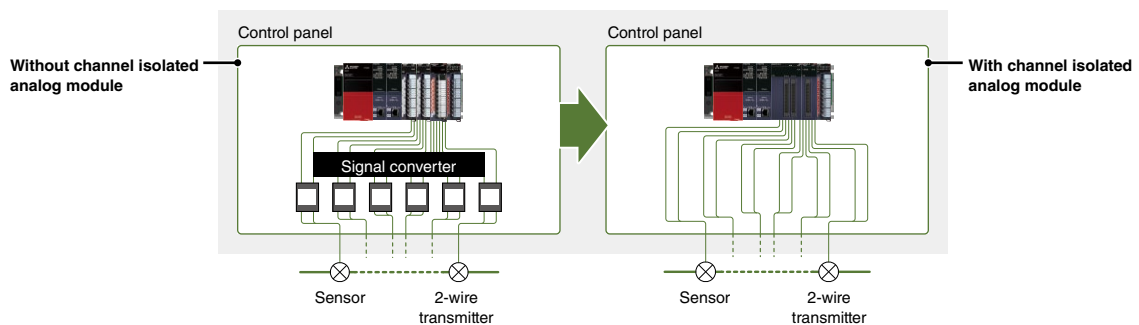
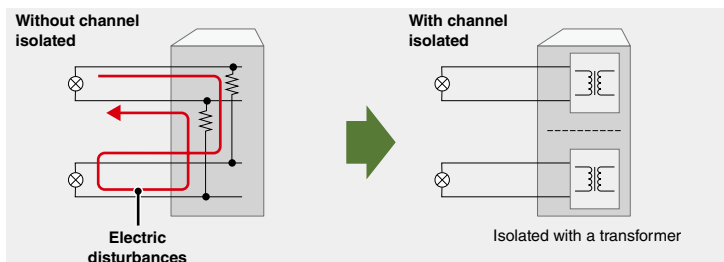

CPU

I/O

Analog/  
temperature input/  
temperature control

Motion/  
positioning

High-speed counter/  
isolated pulse/  
flexible high-speed I/O

PLC

Network

Advanced  
Information

Energy  
measuring

Software

**High-speed and high-resolution sampling cycle visualizes small changes**

R60ADH4

High-speed sampling

High resolution

- The high-speed analog input module achieves a high-speed (1  $\mu$ s/channel) and high-resolution (15- or 16-bit) sampling cycle. Even small changes in sensor output values can be sampled

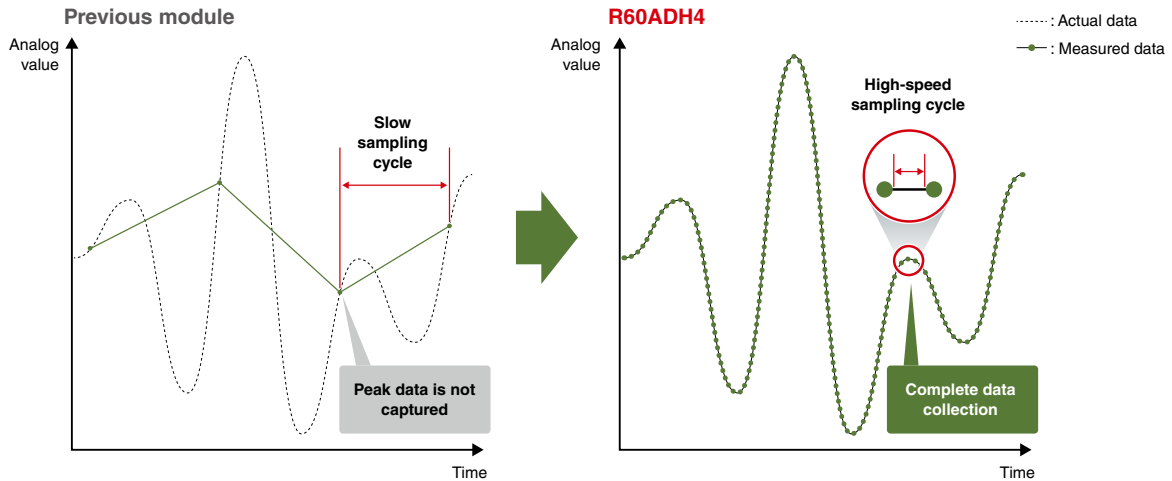

**First-order delay filter eliminating high-frequency noise**

Input

High-frequency noise removal

No programming

- The analog modules include a first-order delay filter that eliminates high-frequency noise interference and improves the accuracy of input analog signals
- Filter time constants can be easily setup using the module's dedicated parameters, thereby improving the processing time as an additional setup program (ladder) is not required

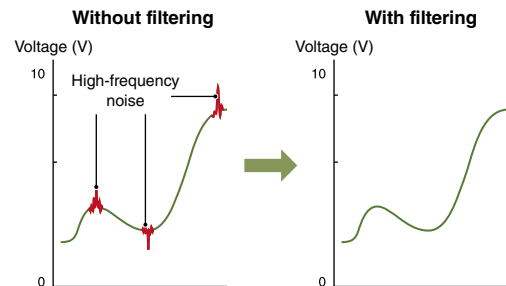
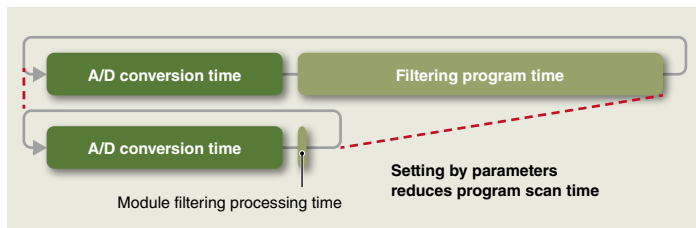

In-line level monitor

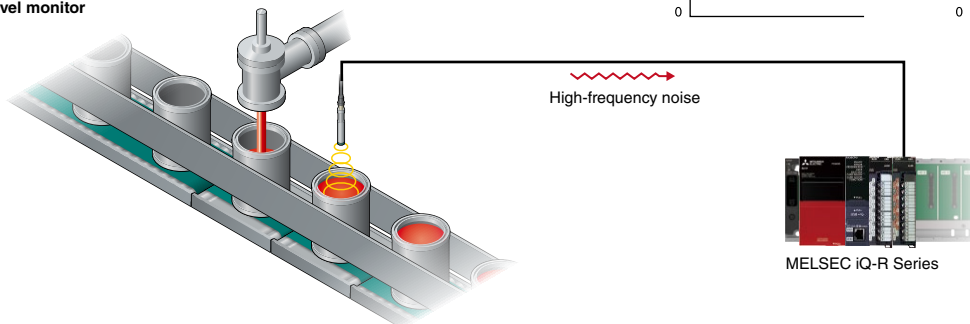

### Simplified preventative maintenance with event driven performance\*1

Input

Easy preventive maintenance

Prompt measures

■ With the enhanced interrupt function by warning output flag, corrective interrupt procedures can be triggered or an alarm generated to initiate proper countermeasures regardless of the program scan time

\*1. A program that executes a process when requests such as operating a mouse and pressing a button are received. As programs can be executed per event, dividing processes and development are easy.

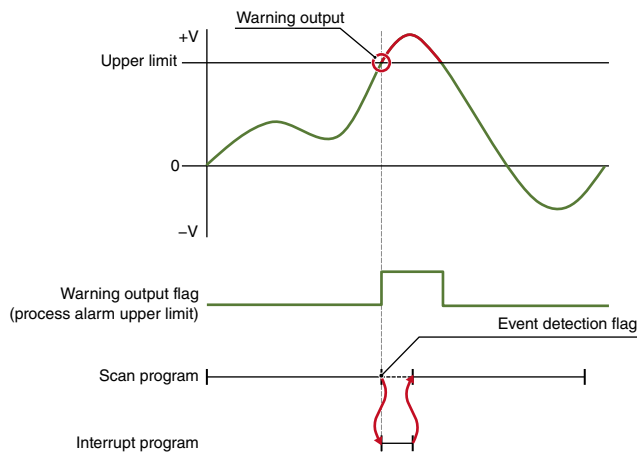

### High-speed data collection highly demanded in industrial applications

Input

High-speed data collection

Error identification

- Equipped with a logging function that collects analog input data at high speed, a large amount of data (up to 10k points) can be saved per channel
- Data collection can be stopped at an arbitrary timing in the program or data status changes as a hold trigger, enabling identification of an error and test data collection easily
- Data logging can be used in applications such as a motor inspection line, where motor performance can be logged at high speed and certain values such as voltage, current, torque and rotational speed analyzed through comparisons with different test patterns

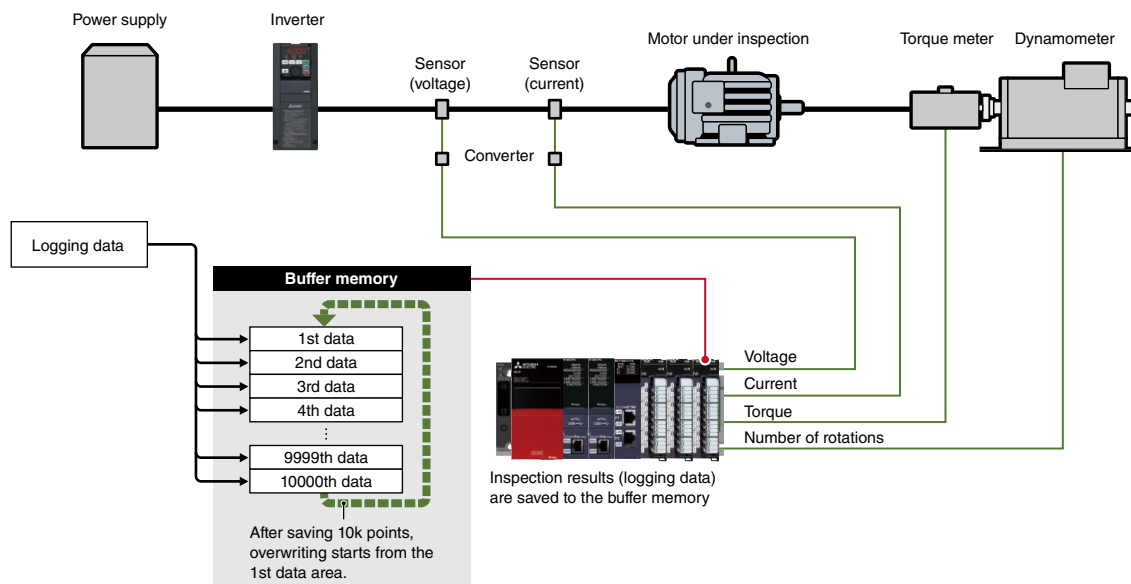

CPU

I/O

Analog/  
temperature input/  
temperature control

Motion/  
positioning

High-speed counter/  
isolated pulse/  
flexible high-speed I/O

PLC

Network

Advanced  
information

Energy  
measuring

Software

### Analog input module supporting 2-wire transmitter

R60AD6-DG

2-wire transmitter supported

Downtime reduction

- The channel isolated analog input module can supply power to the 2-wire transmitter, eliminating a dedicated power supply
- Power supply to the 2-wire transmitter can be temporarily stopped for each channel even when a failure occurs, allowing maintenance without stopping the system, thereby reducing downtime

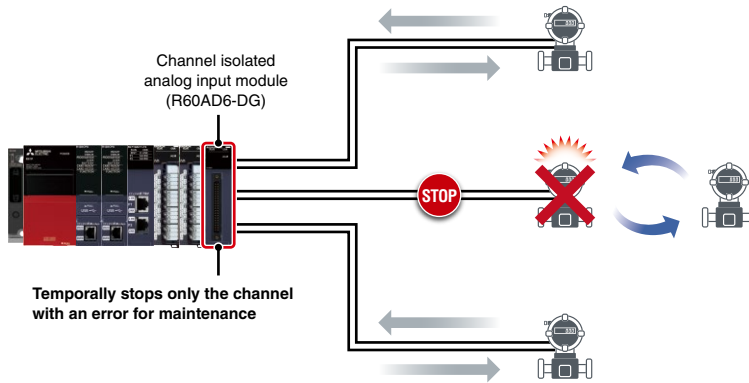

### HART® communication protocol allows communication with field devices

R60ADI8-HA

HART® communication supported

Remote registration from the master

- The HART® communication protocol supporting analog input module can perform analog signal input as well as diagnostics of devices with HART® communication, therefore system maintenance is easy
- Various commands such as parameter registration of HART® communication-supporting field devices can be remotely set from the HART® communication protocol supporting analog input module

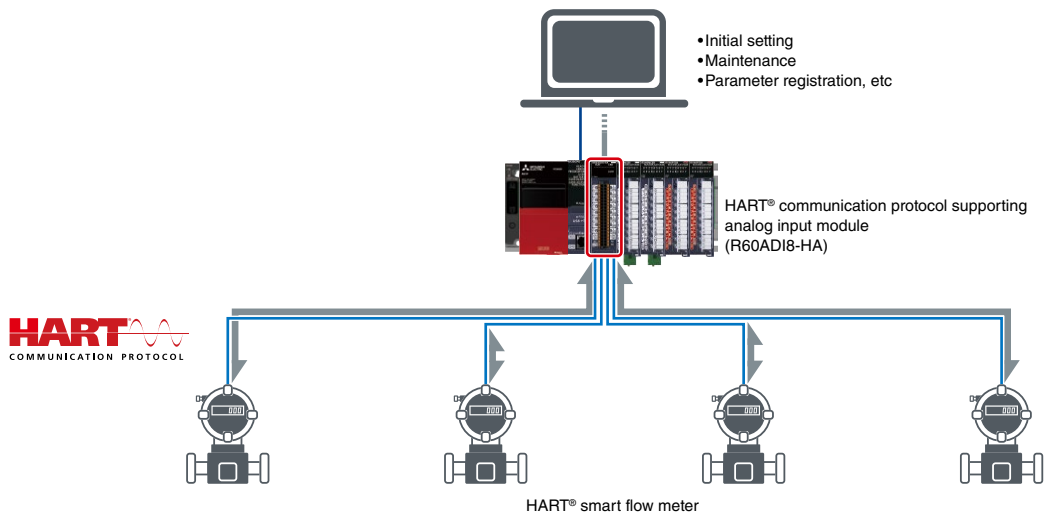



**Faster, smoother predefined wave signal output**

Output

Output pre-registered waveforms

Reduced programming

- The analog output module enables pre-registered waveforms easily, realizing smoother continuous output at high-speed than program
- Registering the waveform in the module enables analog waveform control
- A dedicated analog output program such as for continuous control is not required, further reducing programming time

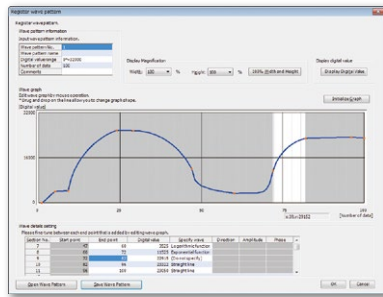

Engineering software GX Works3 wave output data setup

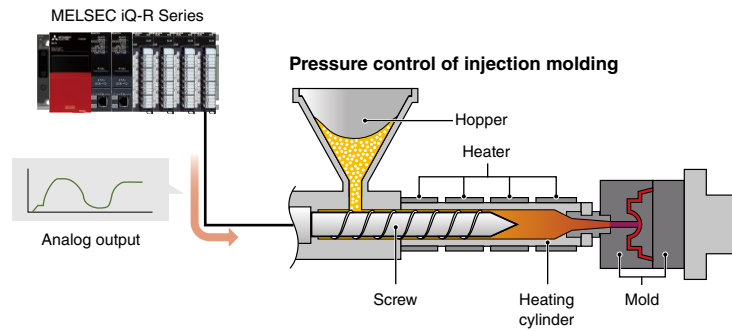

**Analog input module specifications**

Item	R60AD4	R60ADV8	R60ADI8	R60ADI8-HA	R60AD8-G	R60AD16-G
Number of analog input points (ch)	4	8	8	8	8	16
<b>Accuracy</b>						
Ambient temperature 25 ± 5 °C	Within ±0.1 %	Within ±0.1 %	Within ±0.1 %	Within ±0.1 %	Within ±0.1 %	Within ±0.1 %
Ambient temperature 0...55 °C	Within ±0.3 %	Within ±0.3 %	Within ±0.3 %	Within ±0.3 %	-	-
Temperature coefficient (ppm/°C)	-	-	-	-	±35	±35
<b>Common</b>						
Conversion speed	80 μs/channel	80 μs/channel	80 μs/channel	-	10 ms/channel	10 ms/channel
Sampling cycle	-	-	-	80 ms/8 channels	-	-
Channel isolation	-	-	-	-	Transformer isolation	Transformer isolation
Absolute max. input	±15 V, 30 mA	±15 V	30 mA	30 mA	±15 V, 30 mA	±15 V, 30 mA
External power supply (V DC)	-	-	-	24	-	-
SIL2 mode	-	-	-	-	●*1	-
HART® communication	-	-	-	●	-	-
<b>Voltage input</b>						
Analog input voltage (V DC)	-10...10	-10...10	-	-	-10...10	-10...10
Digital output value	-32000...32000	-32000...32000	-	-	-32000...32000	-32000...32000
<b>Current input</b>						
Analog input current (mA DC)	0...20	-	0...20	0...20, 4...20 (when using HART® communication)	0...20	0...20
Digital output value	0...32000	-	0...32000	0...32000	0...32000	0...32000
<b>External interface*2</b>						
Spring-clamp terminal block	-	-	-	●	-	-
18-point screw terminal block	●	●	●	-	-	-
40-pin connector	-	-	-	-	●	● (2x)

\*1. Used when the SIL 2-supporting redundant system is configured.

\*2. For more information about external interface, please refer to the options list on page 156 (for applicable options, please refer to the relevant product manual).

CPU  
I/O  
Analog/temperature input/temperature control  
Motion/positioning  
High-speed counter/ isolated pulse/ flexible high-speed I/O  
FPGA  
Network  
Advanced information  
Energy measuring  
Software

### High-speed analog input module specifications

Item	R60ADH4
Number of analog input points (ch)	4
Accuracy	
Ambient temperature 25 ± 5°C	Within ±0.1%
Ambient temperature 0...55°C	Within ±0.2%
Input specifications	
Operation mode (sampling cycle)	Normal mode (high speed: 1 μs/channel)
	Normal mode (medium speed: 10 μs/channel)
	Normal mode (low speed: 20 μs/channel)
	Simultaneous conversion mode (5 μs/4 channels)
Absolute max. input	±15 V, 30 mA
Voltage input	
Analog input voltage (V DC)	-10...10
Digital output value	-32000...32000
Current input	
Analog input current (mA DC)	0...20
Digital output value	0...32000
External interface*1	
18-point screw terminal block	●

\*1. For more information about external interface, please refer to the options list on page 156 (for applicable options, please refer to the relevant product manual).

### Channel isolated analog input module specifications

Item	R60AD6-DG
Number of analog input points (ch)	6
Reference accuracy	
Ambient temperature 25 ± 5°C	Within ±0.1 %
Temperature coefficient (ppm/°C)	±35
Common	
Conversion speed (ms/channel)	10
Channel isolation	Transformer isolation
External power supply (V DC)	24
Input from 2-wire transmitter	
Analog input current (mA DC)	4...20
Digital output value	0...32000
Current input	
Analog input current (mA DC)	0...20
Digital output value	0...32000
External interface*2	
40-pin connector	●

\*2. For more information about external interface, please refer to the options list on page 156 (for applicable options, please refer to the relevant product manual).

**Analog output module specifications**

Item	R60DA4	R60DAV8	R60DAI8	R60DA8-G	R60DA16-G
Number of analog output points (ch)	4	8	8	8	16
<b>Accuracy</b>					
Ambient temperature 25 ± 5 °C	Within ±0.1 %	Within ±0.1 %	Within ±0.1 %	-	-
Ambient temperature 0...55 °C	Within ±0.3 %	Within ±0.3 %	Within ±0.3 %	-	-
<b>Reference accuracy</b>					
Ambient temperature 25 ± 5 °C	-	-	-	Within ±0.1 %	Within ±0.1 %
Temperature coefficient (ppm/°C)	-	-	-	±50	±50
<b>Common</b>					
Conversion speed	80 μs/channel	80 μs/channel	80 μs/channel	1 ms/channel	1 ms/channel
Channel isolation	-	-	-	Transformer isolation	Transformer isolation
Output short-circuit protection	●	●	●	●	●
External power supply (V DC)	24	24	24	24	24
SIL2 mode	-	-	-	● <sup>*1</sup>	-
<b>Voltage output</b>					
Digital input value	-32000...32000	-32000...32000	-	-32000...32000	-32000...32000
Analog output voltage (V DC)	-10...10	-10...10	-	-12...12	-12...12
<b>Current output</b>					
Digital input value	0...32000	-	0...32000	0...32000	0...32000
Analog output current (mA DC)	0...20	-	0...20	0...20	0...20
<b>External interface<sup>*2</sup></b>					
18-point screw terminal block	●	●	●	-	-
40-pin connector	-	-	-	●	● (2x)

\*1. Used when the SIL 2-supporting redundant system is configured.

\*2. For more information about external interface, please refer to the options list on page 156 (for applicable options, please refer to the relevant product manual).

**High-speed analog output module specifications**

Item	R60DAH4
Number of analog output points (ch)	4
<b>Accuracy</b>	
Ambient temperature 25 ± 5 °C	Within ±0.1 %
Ambient temperature 0...55 °C	Within ±0.3 %
<b>Output specifications</b>	
Conversion speed (μs/channel)	High-speed output mode: 1
	Normal output mode: 10
	Wave output mode: 20
<b>Voltage output</b>	
Digital input value	-32000...32000
Analog output voltage (V DC)	-10...10
<b>Current output</b>	
Digital input value	0...32000
Analog output current (mA DC)	0...20
<b>Common</b>	
External power supply (V DC)	24
<b>External interface<sup>*3</sup></b>	
18-point screw terminal block	●

\*3. For more information about external interface, please refer to the options list on page 156 (for applicable options, please refer to the relevant product manual).

CPU

I/O

Analog/  
temperature input/  
temperature control

Motion/  
positioning

High-speed counter/  
isolated pulse/  
flexible high-speed I/O

FPGA

Network

Advanced  
information

Energy  
measuring

Software

# Temperature input module

## Temperature control module

The temperature input module is ideal for temperature measurement and the temperature control module is for applications requiring highly stable and responsive temperature control. The modules include thermocouple, RTD input types and temperature control modules which are available with or without heater disconnection detection.

### Temperature input module



R60TD8-G

**R60TD8-G**  
40-pin connector

Thermocouple input: 8-channel

**R60RD8-G**  
40-pin connector

RTD input: 8-channel

### Temperature control module

#### Without heater disconnection detection



R60TCRT2TT2-TS

**R60TCRT2TT2-TS**  
Spring-clamp terminal block

Thermocouple input: 2-channel

Thermocouple/RTD input (shared): 2-channel

**R60TCRT2TT2**  
Screw terminal block

Thermocouple input: 2-channel

Thermocouple/RTD input (shared): 2-channel

**R60TCRT4-TS**  
Spring-clamp terminal block

RTD input: 4-channel

**R60TCRT4**  
Screw terminal block

RTD input: 4-channel

#### With heater disconnection detection



R60TCRT2TT2BW

**R60TCRT2TT2BW**  
Screw terminal block

Thermocouple input: 2-channel

Thermocouple/RTD input (shared): 2-channel

**R60TCRT4BW**  
Screw terminal block

RTD input: 4-channel

### Two types of temperature sensors (thermocouple, RTD) are supported

The modules support two types of temperature sensors (thermocouple, RTD) to cover a wide range of requirements

Item	R60TD8-G	R60RD8-G	R60TCRT2TT2-TS	R60TCRT2TT2	R60TCRT2TT2BW	R60TCRT4-TS	R60TCRT4	R60TCRT4BW
Usable thermocouple	B, R, S, K, E, J, T, N	-	B, R, S, K, E, J, T, N, U, L, PLII, W5Re/W26Re	-	-	-	-	-
Usable RTD	-	Pt100, JPt100, Ni100, Pt50	Pt100, JPt100	-	-	Pt100, JPt100	-	-

Controlled heating minimizes distortion in heating profile

Temperature control

Rejection rate reduction

Productivity and quality improvement

- Temperature fluctuations are attenuated at high speed through the external disturbance suppression function. This enables the preset temperature value to be maintained, ensuring a uniform heating profile not influenced by heating variations in the product
- Due to its high-speed response capabilities, this function can be used in applications such as package machine sealing, injection molding, and for wafer plates in semiconductor production



External disturbance suppression

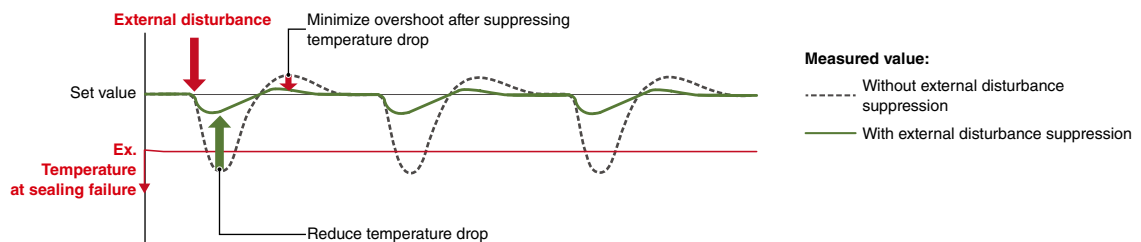

Temperature trace realizing real-time temperature waveform monitoring

Temperature control

Real-time temperature trace

Export as a CSV file

- Setting parameters has been simplified when using the temperature trace feature of engineering software GX Works3. This simple-to-use feature enables tracing of various temperature values in real-time, helping to visualize the control performance while adjusting the parameters
- Temperature values can also be exported as a CSV file

Temperature waveform monitored in real-time

Adjust parameters against temperature waveform

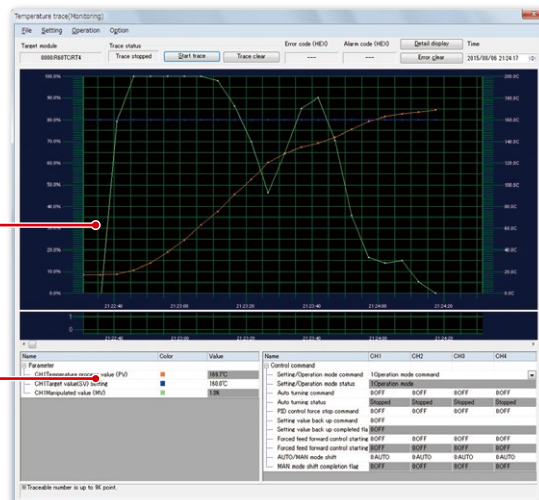

Temperature data can be saved as a CSV file

Temperature trace window

CPU

I/O

Analog/temperature input/temperature control

Motion/positioning

High-speed counter/ isolated pulse/ flexible high-speed I/O

FPGA

Network

Advanced information

Energy measuring

Software

## Coordination between multiple temperature control modules

Temperature control



### Inter-module simultaneous temperature rise

Uniform temperature control

Energy saving

- Temperature uniformity is realized by aligning the timing of multiple loops when reaching the set value
- Up to 64 modules can be divided into 16 groups (max.) and simultaneous temperature rise function is set. The energy is saved because the time taken for the temperature rise can be adjusted through an entire system

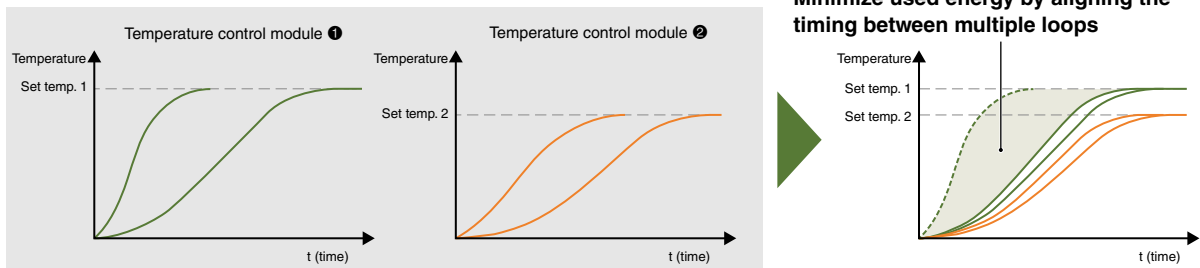

Minimize used energy by aligning the timing between multiple loops

### Inter-module peak current suppression contributes to energy saving

Peak current suppression

Power supply capacity reduction

Energy saving

- Peak current is reduced by spreading out the control output timing of transistors
- High and low power usage periods are grouped together, reducing an energy consumption of the facility

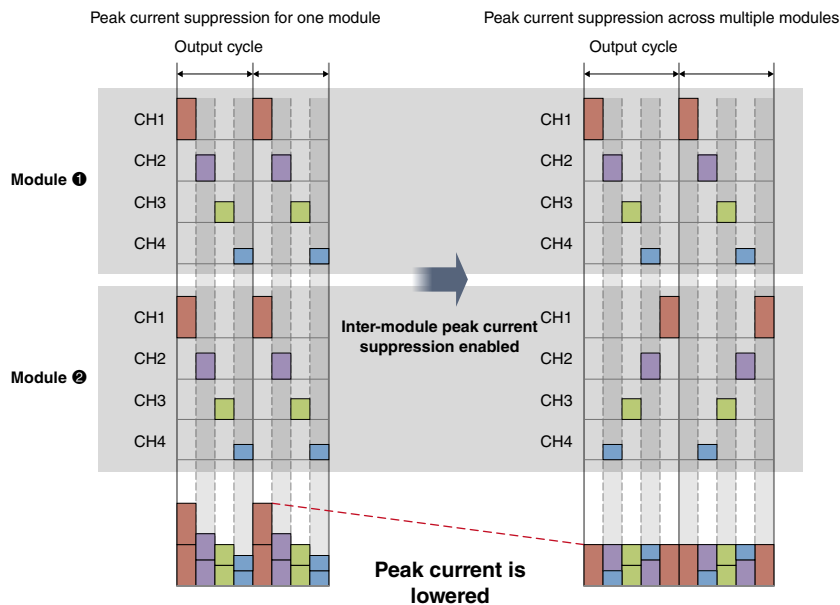

Temperature input module specifications

Item	R60TD8-G	R60RD8-G
Number of analog input points (ch)	8	8
Cold junction temperature compensation accuracy (°C)	±1.0	-
Usable thermocouple	B, R, S, K, E, J, T, N	-
Usable RTD	-	Pt100, JPt100, Ni100, Pt50
Resolution (°C)	B, R, S, N: 0.3 K, E, J, T: 0.1	0.1
Conversion speed (ms/channel)	30	10
Channel isolation	Transformer isolation	Transformer isolation
Wire break detection	●	●
Output		
Measured temperature value (16-bit signed binary data)	-2700...18200	-2000...8500
Scaling value (16-bit signed binary data)	●	●
External interface*1		
40-pin connector	●	●

\*1. For more information about external interface, please refer to the options list on page 156 (for applicable options, please refer to the relevant product manual).

Temperature control module specifications

Item	R60TCRT2T2-TS	R60TCRT2T2	R60TCRT4-TS	R60TCRT4	R60TCRT2T2BW	R60TCRT4BW
Number of analog input points (ch)	4*2		4		4*2	4
Usable thermocouple	B, R, S, K, E, J, T, N, U, L, PLII, W5Re/W26Re		-		B, R, S, K, E, J, T, N, U, L, PLII, W5Re/W26Re	-
Usable RTD	Pt100, JPt100		Pt100, JPt100		Pt100, JPt100	Pt100, JPt100
Sampling cycle (ms/4CH)	250, 500		250, 500		250, 500	250, 500
Control output cycle (s)	0.5...100		0.5...100		0.5...100	0.5...100
Input impedance (Ω)	1M		1M		1M	1M
Input filter (0: Input filter OFF) (s)	0...100		0...100		0...100	0...100
Sensor correction value setting	(-full scale of input range) to full scale of input range					
Operation at a sensor input disconnection	Upscale processing					
Temperature control method	PID ON/OFF pulse or two-position control					
Heater disconnection detection	-		-		●	●
Indication accuracy*3						
Ambient temperature 25 ± 5 °C	Full scale x (±0.3 %)		Full scale x (±0.3 %)		Full scale x (±0.3 %)	Full scale x (±0.3 %)
Ambient temperature 0...55 °C	Full scale x (±0.7 %)		Full scale x (±0.7 %)		Full scale x (±0.7 %)	Full scale x (±0.7 %)
PID constants range						
PID constants setting	Setting by auto tuning is available.					
Proportional band (P)	0 (0.0)...full scale of input range (depending on the decimal point position) (0: Two-position control)					
Integral time (I) (s)	0...3600 (Set 0 for P control and PD control.)					
Derivative time (D) (s)	0...3600 (Set 0 for P control and PI control.)					
Transistor output						
Output signal	ON/OFF pulse		ON/OFF pulse		ON/OFF pulse	ON/OFF pulse
Rated load voltage (V DC)	10...30		10...30		10...30	10...30
Maximum load current	0.1 A/point 0.4 A/common		0.1 A/point 0.4 A/common		0.1 A/point 0.4 A/common	0.1 A/point 0.4 A/common
Maximum inrush current	0.4 A, 10 ms		0.4 A, 10 ms		0.4 A, 10 ms	0.4 A, 10 ms
External interface*4						
Spring-clamp terminal block	●	-	●	-	-	-
18-point screw terminal block	-	●	-	●	● (2x)	● (2x)

\*2. For channel 1 and channel 2, either thermocouple input or RTD input can be selected.

\*3. The accuracy is calculated using the following formula. For details, please refer to the "MELSEC iQ-R Temperature Control Module User's Manual (Startup) (SH-081535ENG)." (Only when it is not affected by noise.)

Accuracy (°C) = (indication accuracy) + (cold junction temperature compensation accuracy)

\*4. For more information about external interface, please refer to the options list on page 156 (for applicable options, please refer to the relevant product manual).

CPU

I/O

Analog/  
temperature input/  
temperature control

Motion/  
positioning

High-speed counter/  
isolated pulse/  
flexible high-speed I/O

FFGA

Network

Advanced  
Information

Energy  
measuring

Software

# Motion module, Positioning module

High-speed/high-performance systems and equipment are mandatory requirements for productivity improvement of factory. In addition, high-speed and high-accuracy motion control is necessary to drive many servo motors to support complicated processes.

The MELSEC iQ-R Series offers a variety of modules dedicated to motion control. The module can be selected according to necessary functions such as number of controllable axes, supported networks, and development environments.

## Functional level



## Motion module

CC-Link **IE TSN**



Simple motion mode		PLCopen® mode	
RD78G4	4-axis		
RD78G8	8-axis		
RD78G16	16-axis		
		PLCopen® mode	
RD78G32	32-axis		
RD78G64	64-axis		

CC-Link **IE TSN**



PLCopen® mode : PLCopen® motion control FB mode

PLCopen® mode	
RD78GHV	128-axis
RD78GHW	256-axis

## Simple motion module

CC-Link **IE F**ield



RD77GF4	4-axis
RD77GF8	8-axis
RD77GF16	16-axis
RD77GF32	32-axis

SSCNET **III/H**  
SERVO SYSTEM CONTROLLER NETWORK



RD77MS2	2-axis
RD77MS4	4-axis
RD77MS8	8-axis
RD77MS16	16-axis

## Positioning module

Open collector output



RD75P2	2-axis
RD75P4	4-axis

Differential driver output



RD75D2	2-axis
RD75D4	4-axis



## Easy programming utilizing existing assets

Motion

Easy programming

Reducing development time

- The simple motion mode enables the motion module to utilize existing assets for configuring high-performance servo equipment. Reusing existing projects helps to reduce the program development time
- Executes positioning control with the motion profile table and synchronous control with parameter settings
- Remote devices can be connected via CC-Link IE TSN and programmed from the programmable controller CPU module

### Programming in simple motion mode

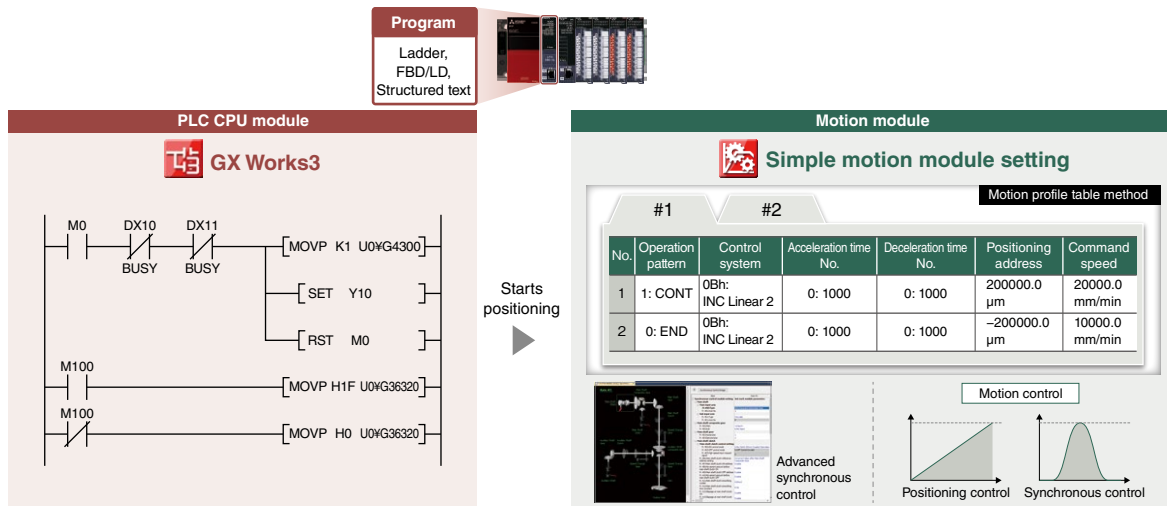

## Motion control with function block (FB)

Motion

Reducing programming burden

Load separation from PLC CPU

- In PLCopen® motion control FB mode, motion control is possible utilizing the library of PLCopen® motion control FBs which are compliant with international standards
- Programming is possible by the programmable controller CPU module only, reducing engineering time
- The motion module performs high-speed and high-accuracy motion control. Operations in ST language is possible, allowing the control load to be separated from the programmable controller CPU module

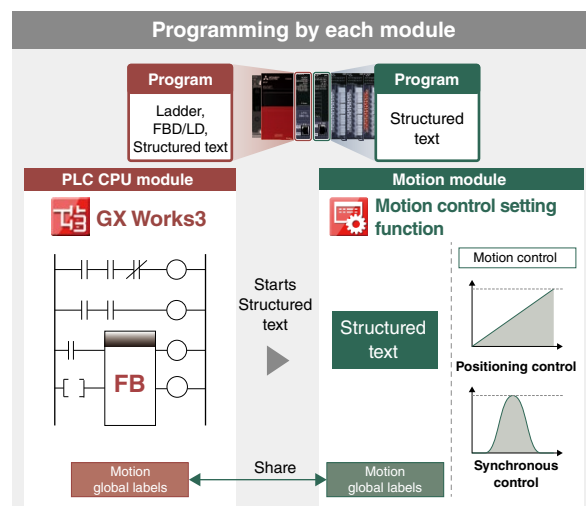
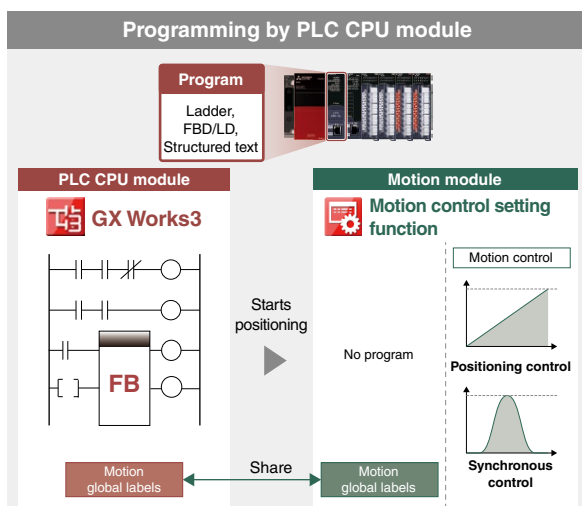

CPU

I/O

Analog/temperature input/temperature control

Motion/positioning

High-speed counter/ isolated pulse/ flexible high-speed I/O

FFGA

Network

Advanced information

Energy measuring

Software

**Software-based synchronous and cam control as an alternative to mechanical control**

Motion

Simple motion

Compact system

Easy changeover

- Compact motion system without gears and cams can be configured, eliminating concerns about wear and life
- System performance will improve as mechanical parts causing accuracy errors are no longer used
- Cam replacement when switching a product type can be easily achieved by simply changing cam data

Software-based synchronous control replacing mechanical control such as gear, shaft, transmission, and cam

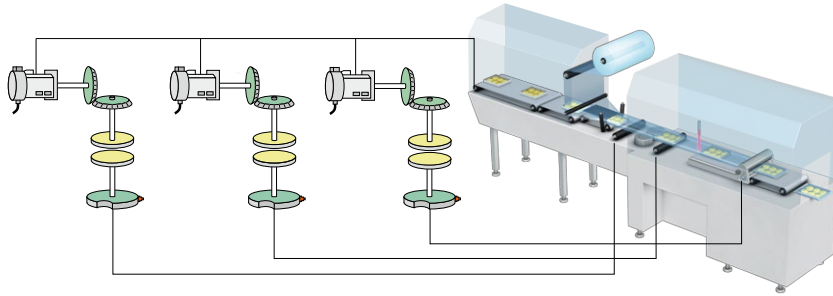

**Cycle time reduction by smooth switching**

Motion

Simple motion

No shock to the machine

Reducing cycle time

- Position control is smoothly switched to torque control (continuous operation to torque control) without stopping the servo motor nor shocking the machine
- The current positions are always tracked even in torque control, and therefore positioning at high speed is possible even after control is switched back to position control, reducing the cycle time

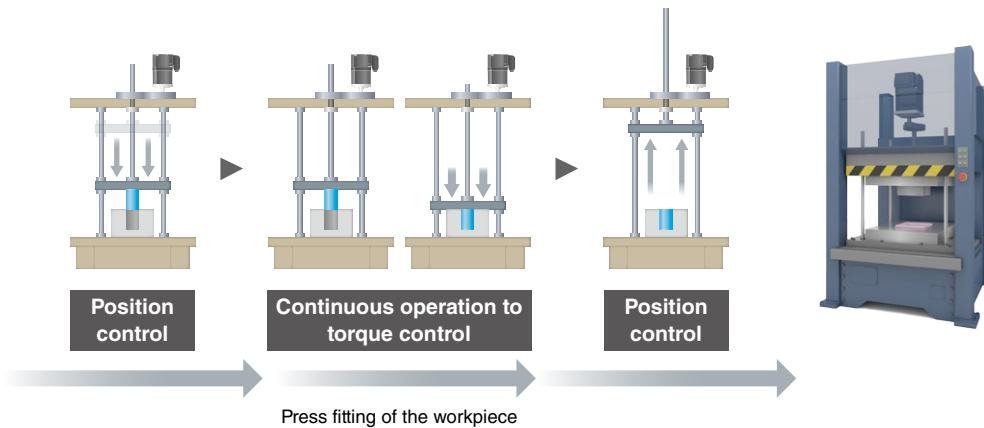

### A series of control synchronizing with the workpiece movement

Simple motion

Positioning

- By combining positioning data with starting methods such as multiple axes simultaneous start, quick start, and block start, a series of motion controls synchronizing with the workpiece movement can be performed

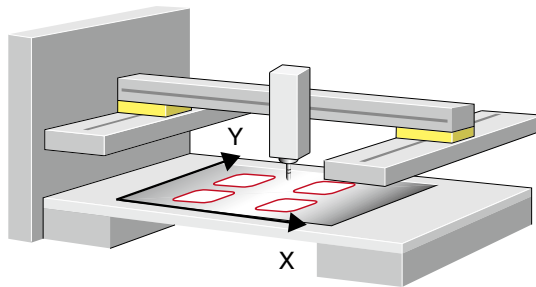

4 path profiles (P1...P4) being drawn in sequence by block start

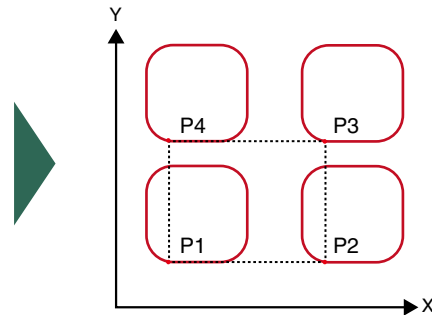

### Boring processing by the motion system

Simple motion

Positioning

High-accuracy processing

- The linear interpolation axis (linear control) follows 2-axis circular interpolation control to achieve helical interpolation of a spiral trajectory
- For applications that require the boring of deep and large holes, high-accuracy processing is possible with the motion system using 3-axis helical interpolation control (X, Y, and Z)

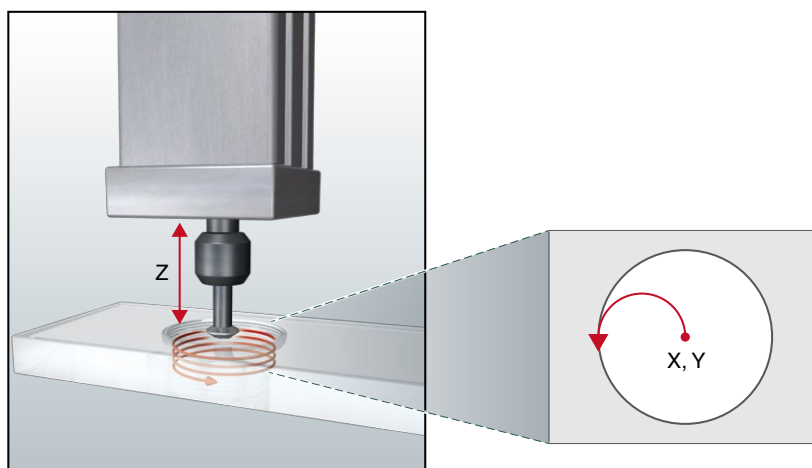

CPU

I/O

Analog/  
temperature input/  
temperature control

Motion/  
positioning

High-speed counter/  
isolated pulse/  
flexible high-speed I/O

FPGA

Network

Advanced  
information

Energy  
measuring

Software

**Motion module specifications (PLCopen® motion control FB mode)**

Item	RD78G4	RD78G8	RD78G16	RD78G32	RD78G64	RD78GHV	RD78GHW
Max. number of control axes	4	8	16	32	64	128	256
Operation cycle settings	62.5 μs...8 ms	62.5 μs...8 ms	62.5 μs...8 ms	62.5 μs...8 ms	62.5 μs...8 ms	31.25 μs...8 ms	31.25 μs...8 ms
Program capacity (built-in ROM) (byte)	16M	16M	16M	16M	16M	64M	64M
Servo amplifier connection							
Servo amplifier	MR-J5-G MR-J5W-G MR-J5D-G4	MR-J5-G MR-J5W-G MR-J5D-G4	MR-J5-G MR-J5W-G MR-J5D-G4	MR-J5-G MR-J5W-G MR-J5D-G4	MR-J5-G MR-J5W-G MR-J5D-G4	MR-J5-G MR-J5W-G MR-J5D-G4	MR-J5-G MR-J5W-G MR-J5D-G4
CC-Link IE TSN	●	●	●	●	●	●	●
Max. station-to-station distance (m)	100	100	100	100	100	100	100
Interpolation function							
Linear interpolation (axis)	Max. 4	Max. 4	Max. 4	Max. 4	Max. 4	Max. 4	Max. 4
Circular interpolation (axis)	2	2	2	2	2	2	2
Control method							
Positioning control	●	●	●	●	●	●	●
Speed control	●	●	●	●	●	●	●
Torque control	●	●	●	●	●	●	●
Synchronous control	●	●	●	●	●	●	●
Cam control	●	●	●	●	●	●	●
Acceleration/deceleration process							
Trapezoidal acceleration/deceleration	●	●	●	●	●	●	●
Jerk acceleration/deceleration	●	●	●	●	●	●	●
Function							
Absolute position system	●	●	●	●	●	●	●
Touch probe	●	●	●	●	●	●	●

**Motion module specifications (simple motion mode)**

Item	RD78G4	RD78G8	RD78G16
Max. number of control axes	4	8	16
Operation cycle settings (μs)	250, 500, 1000, 2000, 4000	250, 500, 1000, 2000, 4000	250, 500, 1000, 2000, 4000
Number of positioning data (data/axis)	600	600	600
Servo amplifier connection			
Servo amplifier	MR-J5-G MR-J5W-G MR-J5D-G4	MR-J5-G MR-J5W-G MR-J5D-G4	MR-J5-G MR-J5W-G MR-J5D-G4
CC-Link IE TSN	●	●	●
Max. station-to-station distance (m)	100	100	100
Interpolation function			
Linear interpolation (axis)	Max. 4	Max. 4	Max. 4
Circular interpolation (axis)	2	2	2
Helical interpolation (axis)	3	3	3
Control method			
Positioning control	●	●	●
Speed control	●	●	●
Torque control	●	●	●
Continuous operation to torque control	●	●	●
Synchronous control	●	●	●
Cam control	●	●	●
Acceleration/deceleration process			
Trapezoidal acceleration/deceleration	●	●	●
S-curve acceleration/deceleration	●	●	●
Function			
Absolute position system	●	●	●
Mark detection function	●	●	●

Simple motion module specifications

Item	RD77GF4	RD77GF8	RD77GF16	RD77GF32	RD77MS2	RD77MS4	RD77MS8	RD77MS16
Number of control axes	4	8	16	32	2	4	8	16
Operation cycle settings (ms)	0.5, 1.0, 2.0, 4.0	0.5, 1.0, 2.0, 4.0	0.5, 1.0, 2.0, 4.0	0.5, 1.0, 2.0, 4.0	0.444, 0.888, 1.777, 3.555	0.444, 0.888, 1.777, 3.555	0.444, 0.888, 1.777, 3.555	0.444, 0.888, 1.777, 3.555
Control unit	mm, inch, degree, pulse	mm, inch, degree, pulse	mm, inch, degree, pulse	mm, inch, degree, pulse	mm, inch, degree, pulse	mm, inch, degree, pulse	mm, inch, degree, pulse	mm, inch, degree, pulse
Positioning data (data/axis)	600	600	600	600	600	600	600	600
Servo amplifier	MR-J4-GF	MR-J4-GF	MR-J4-GF	MR-J4-GF	MR-J4-B MR-J4W-B	MR-J4-B MR-J4W-B	MR-J4-B MR-J4W-B	MR-J4-B MR-J4W-B
Max. station-to-station distance (m)	100	100	100	100	100	100	100	100
Servo amplifier connection system								
CC-Link IE Field Network	●	●	●	●	-	-	-	-
SSCNETⅢ/H	-	-	-	-	●	●	●	●
External interface*1								
40-pin connector	-	-	-	-	●	● (2x)	● (2x)	● (2x)
Interpolation function								
Linear interpolation (axis)	Max. 4	Max. 4	Max. 4	Max. 4	Max. 2	Max. 4	Max. 4	Max. 4
Circular interpolation (axis)	2	2	2	2	2	2	2	2
Helical interpolation	●	●	●	●	-	●	●	●
Control method								
Position control	●	●	●	●	●	●	●	●
Speed control	●	●	●	●	●	●	●	●
Torque control	●	●	●	●	●	●	●	●
Continuous operation to torque control	-	-	-	-	●	●	●	●
Advanced synchronous control	●	●	●	●	●	●	●	●
Cam control	●	●	●	●	●	●	●	●
Acceleration/deceleration process								
Trapezoidal acceleration/deceleration	●	●	●	●	●	●	●	●
S-curve acceleration/deceleration	●	●	●	●	●	●	●	●
Function								
Absolute position system*2	●	●	●	●	●	●	●	●
Mark detection function	●	●	●	●	●	●	●	●

\*1. For more information about external interface, please refer to the options list on page 156 (for applicable options, please refer to the relevant product manual).

\*2. Supported when a battery is connected to the servo amplifier. A battery is not required when using a servo motor equipped with a battery-less absolute position encoder.

Positioning module specifications

Item	Open collector output		Differential driver output	
	RD75P2	RD75P4	RD75D2	RD75D4
Number of control axes	2	4	2	4
Control unit	mm, inch, degree, pulse	mm, inch, degree, pulse	mm, inch, degree, pulse	mm, inch, degree, pulse
Positioning data (data/axis)	600	600	600	600
Module backup function	Positioning data and block start data can be saved on flash ROM (battery-less backup)			
Start time (1-axis linear control) (ms)	0.3	0.3	0.3	0.3
Max. output pulse (pulse/s)	200,000	200,000	5,000,000	5,000,000
Max. connection distance between servos (m)	2	2	10	10
Interpolation				
Linear interpolation (axis)	2	2, 3, 4	2	2, 3, 4
Circular interpolation (axis)	2	2	2	2
Helical interpolation (axis)	-	3	-	3
Control method				
PTP (Point To Point) control	●	●	●	●
Path control (linear, arc, helical)	●	●	●	●
Speed control	●	●	●	●
Speed-position switching control	●	●	●	●
Position-speed switching control	●	●	●	●
Acceleration/deceleration process				
Trapezoidal acceleration/deceleration	●	●	●	●
S-curve acceleration/deceleration	●	●	●	●
Fast-start function				
Positioning start signal (μs)	8	8	8	8
External command signal (μs)	20	20	20	20
External interface*3				
40-pin connector	●	● (2x)	● (2x)	● (2x)

\*3. For more information about external interface, please refer to the options list on page 156 (for applicable options, please refer to the relevant product manual).

CPU

I/O

Analog/temperature input/temperature control

Motion/positioning

High-speed counter/ isolated pulse/ flexible high-speed I/O

FPGA

Network



Advanced information

Energy measuring

Software

## High-speed counter module

The high-speed counter modules are capable of up to 200k pulse/s for the DC input, and up to 8M pulse/s for differential input. The movement amount can also be measured when used with a rotary encoder, linear encoder, digital gage, etc. In addition, a signal is output when a specified position is reached.

For open collector/voltage output		For line driver	
	<b>RD62P2</b>	Max. 200k pulse/s	2-channel
		Coincidence output (sink)	
	<b>RD62P2E</b>	Max. 200k pulse/s	2-channel
		Coincidence output (source)	
	<b>RD62D2</b>	Max. 8M pulse/s	2-channel
		Coincidence output (sink)	

### High-accuracy pulse measurement

Measurement resolution 100 ns

High-accuracy measurement

- The pulse measurement function enables measuring of the pulse cycle, which is ideal for applications where workpiece length and speed need to be detected
- In the food and beverage industry, the size and speed of bottles traveling on the conveyor are easily measured using proximity sensors
- Wind turbine speed can be measured from the pulse interval

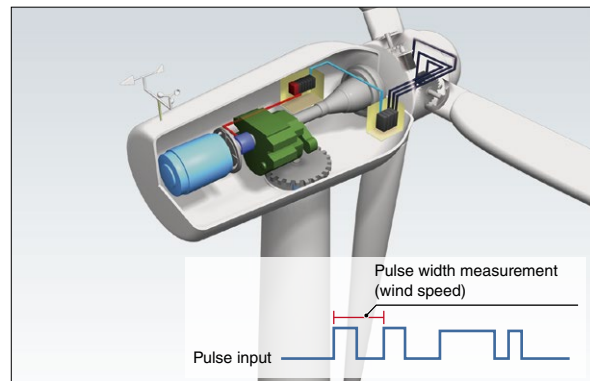
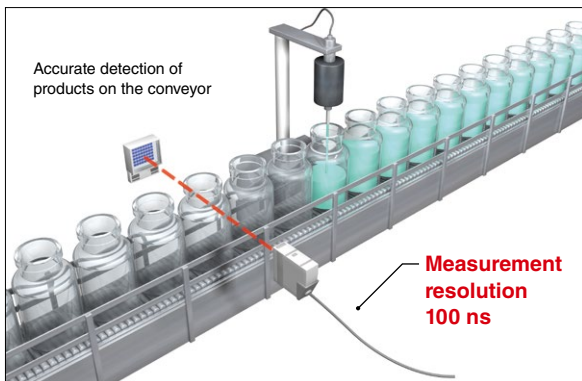

### Smooth operation with PWM output

Max. 200 kHz

Min. 100 ns pulse width

- The PWM output frequency can support up to 200 kHz with a minimum 100 ns pulse width (proportion to “on” time) during the required duty cycle
- The set values can be changed during operation without having to stop the system, such as in industrial-scale fan control

# Channel isolated pulse input module

The channel isolated pulse input module is capable of up to 30k pulse/s for the DC input.



**RD60P8-G**

**Multiple measurement functions and channel isolation are ideal for process control applications**

Multiple measurements

Channel isolation

- One module can measure the number of input pulse data for speed, rotation speed, and instantaneous flow rate and also measure quantity, length, and cumulative flow rate of 8 channels maximum
- Galvanic channel isolation is included which prevents noise interference making it ideal for process control applications

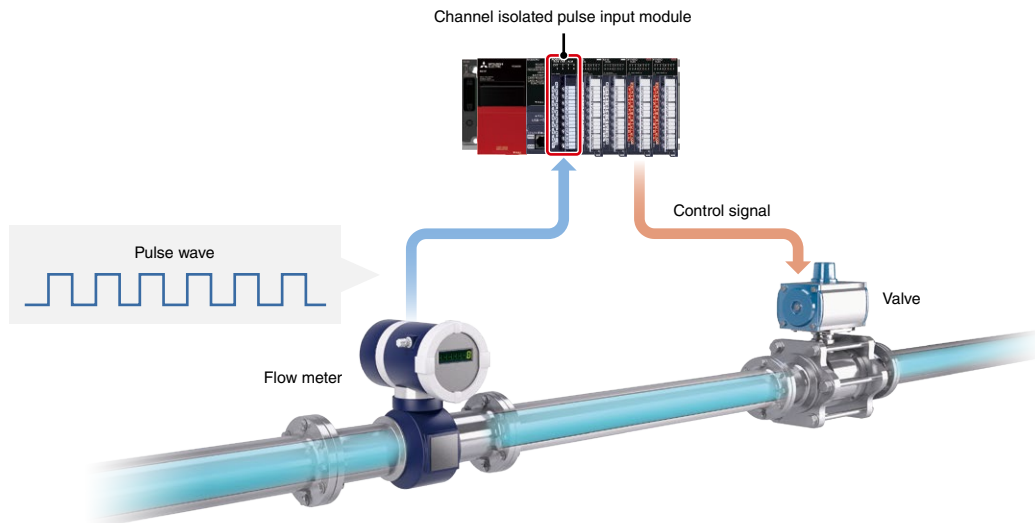

CPU
I/O
Analog/temperature input/temperature control
Motion/positioning
High-speed counter/ isolated pulse/ flexible high-speed I/O
FFGA
Network
Advanced information
Energy measuring
Software

## Flexible high-speed I/O control module

The module includes features such as the ability to program control logic and microsecond-fast asynchronous I/O response times to the programmable controller CPU module and control bus. Ideal for product testing equipment which needs to capture products moving at high-speed.



RD40PD01

### High-speed, stable I/O response

#### Highly accurate I/O response

- Hardware processing without going through the CPU module enables microsecond-fast asynchronous I/O response times
- Stable response time irrespective of processing speed fluctuation

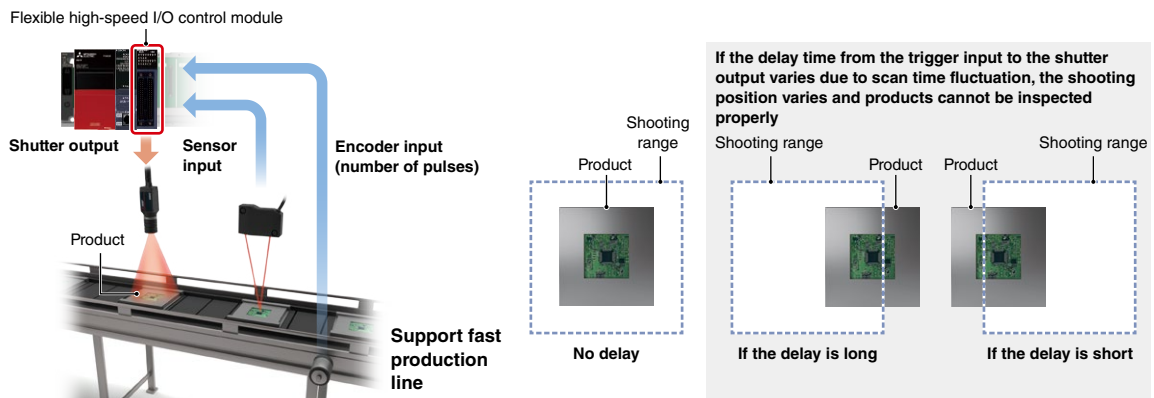

### Easy hardware logic design with intuitive setting tool

#### Easy setup

#### Design cost reduction

- Hardware logic can be programmed easily using the setting tool integrated with engineering software GX Works3
- This low-cost alternative to HDL programming, logic synthesis and timing analysis reduce the design process, which is a common feature of general FPGA logic design

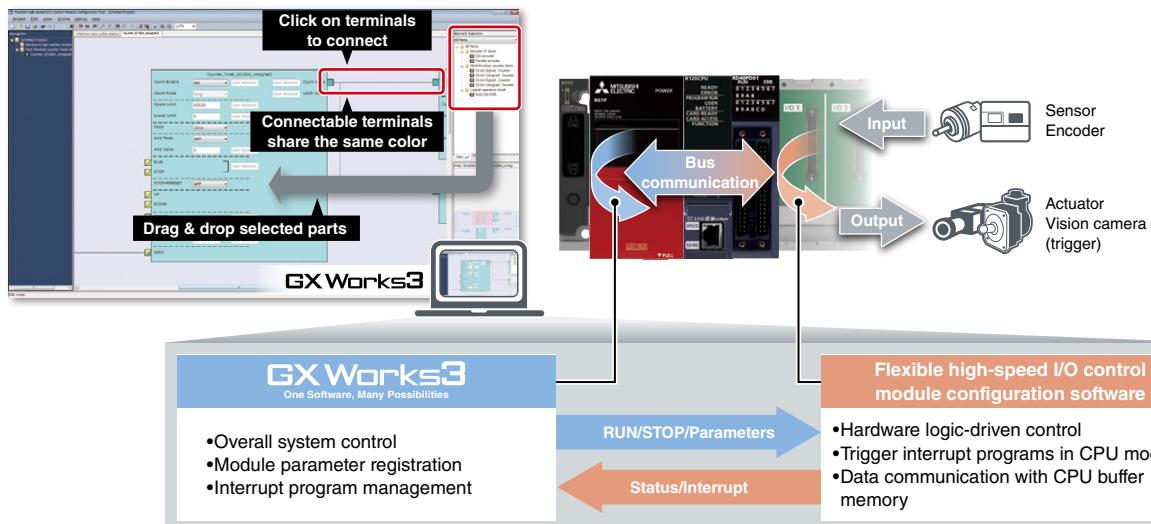



### High-speed counter module specifications

Item	RD62P2	RD62P2E	RD62D2
Number of channels	2	2	2
Count input signal			
1-phase input (1 multiple/2 multiples)	●	●	●
2-phase input (1 multiple/2 multiples/4 multiples)	●	●	●
CW/CCW input	●	●	●
Signal level (αA, αB)	2...5 mA at 5/12/24 V DC	2...5 mA at 5/12/24 V DC	EIA Standard RS-422-A Differential line driver level
Counter			
Max. counting speed (pulse/s)	200k	200k	8M
Counting range	32-bit signed binary (-2147483648...2147483647)	32-bit signed binary (-2147483648...2147483647)	32-bit signed binary (-2147483648...2147483647)
External input			
Preset, function start	7...10 mA at 5/12/24 V DC	7...10 mA at 5/12/24 V DC	7...10 mA at 5/12/24 V DC
Digital filter (ms)	0, 0.1, 1, 10	0, 0.1, 1, 10	0, 0.1, 1, 10
Pulse measurement			
Resolution*1 (ns)	100	100	100
Number of points per channel	1	1	1
External output			
Coincidence output (2 points/channel)	Transistor (sink) output, 12/24 V DC, 0.5 A/point	Transistor (source) output, 12/24 V DC, 0.1 A/point	Transistor (sink) output, 12/24 V DC, 0.5 A/point
PWM output			
Output frequency range (Hz)	DC...200k	DC...200k	DC...200k
Duty ratio	Multiples of 0.1 μs	Multiples of 0.1 μs	Multiples of 0.1 μs
Number of output points per channel	2	2	2
External interface*2			
40-pin connector	●	●	●

\*1. Pulse measurement can be performed in the range of 2000 to 2147483647 (0.2 ms to approx. 214 s).

\*2. For more information about external interface, please refer to the options list on page 156 (for applicable options, please refer to the relevant product manual).

### Channel isolated pulse input module specifications

Item	RD60P8-G
Number of channels	8
Withstand voltage	Between I/O terminals and programmable controller power supply: 500 V AC rms for 1 minute 1780 V AC for 1 minute between channels
Isolation resistance	Between I/O terminals and programmable controller power supply: 10 MΩ or higher, at 500 V DC 10 MΩ or higher, at 500 V DC between channels
Count input signal	
1-phase input	●
Signal level	5 V DC/12...24 V DC
Counter	
Max. counting speed (pulse/s)	30k
Counting range	Sampling pulse number: 16-bit unsigned binary (0...32767) Accumulating count value: 32-bit unsigned binary (0...99999999) Input pulse value: 32-bit unsigned binary (0...2147483647)
Count type	Linear counter, ring counter
External interface*3	
18-point screw terminal block	●

\*3. For more information about external interface, please refer to the options list on page 156 (for applicable options, please refer to the relevant product manual).

### Flexible high-speed I/O control module specifications

Item	RD40PD01	
	DC	Differential
Number of input points	12 (5/24 V DC/differential)	
Number of output points	8 (5...24 V DC, 0.1 A/point)	6
Number of interrupts	8	
Input response time (μs)	≤ 1	
Output response time (μs)	≤ 1	
Max. pulse input speed (pulse/s)	200k (200 kHz)	8M (2 MHz)
Max. pulse output speed (pulse/s)	200k (200 kHz)	8M (2 MHz)
Main functions executable using main block combinations	Pulse count, coincidence detection, cam switch, highly-accurate pulse output, PWM output, ratio setting, pulse measurement, electrical interface conversion	
Main hardware logic processing time	Logic operation: min. 87.5 ns, coincidence output: min. 137.5 ns, cam switch: min. 262.5 ns	
External interface*4		
40-pin connector	● (2x)	

\*4. For more information about external interface, please refer to the options list on page 156 (for applicable options, please refer to the relevant product manual).

CPU

I/O

Analog/  
temperature input/  
temperature control

Motion/  
positioning

High-speed counter/  
isolated pulse/  
flexible high-speed I/O

FFGA

Network

Advanced  
Information

Energy  
measuring

Software

# CC-Link IE TSN-compatible FPGA modules\*1

- Microsecond-fast and highly-accurate I/O response times with a field programmable gate array (FPGA)
- Operation of I/O values is processed on the order of nanoseconds in the FPGA. The logic circuit can be programmed flexibly using the Intel® Quartus® Prime Design software\*2
- Various communication types are available for the Ethernet communication with a higher-level system, from which suitable one can be selected according to the application and conditions. The module can also operate stand-alone during start-up or for incidental facilities
- Customer-designed complex logic circuits can be written to the FPGA. The module is ideal for replacing the existing FPGA boards and microcomputer boards developed in-house
- The module achieves a logging cycle of 1 μs and can automatically send the logging data to an FTP server

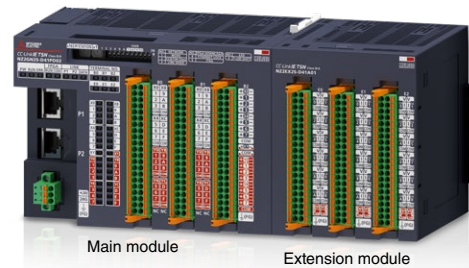

<b>Ethernet communications</b>	CC-Link IE TSN	SLMP, Simple CPU communication	FTP client
<b>FPGA</b>	Intel® Quartus® Prime Design software*2	Circuit capacity <b>149.5 KLE</b>	Ultra-high-speed logging <b>54 kB/μs</b>
<b>I/O</b>	DC I/O <b>max. 192 points</b>	Differential I/O <b>max. 102 points</b>	Analog I/O <b>max. 42 points</b>

\*1. The module can be used stand-alone without having to use a base unit and also connected to the programmable controller using CC-Link IE TSN or Ethernet.  
 \*2. Please contact Intel Corporation for any inquiries on Intel products. Please visit the website below.  
[www.intel.us](http://www.intel.us)

## High-speed, stable responses owing-to FPGA-driven control

### Issue

Performance of conventional I/O modules was synchronous with the programmable controller CPU and control bus, resulting in slow I/O processing and fluctuation of response times.

### Solution

The FPGA module enables high-speed, stable responses with no fluctuation owing to the FPGA-driven control.

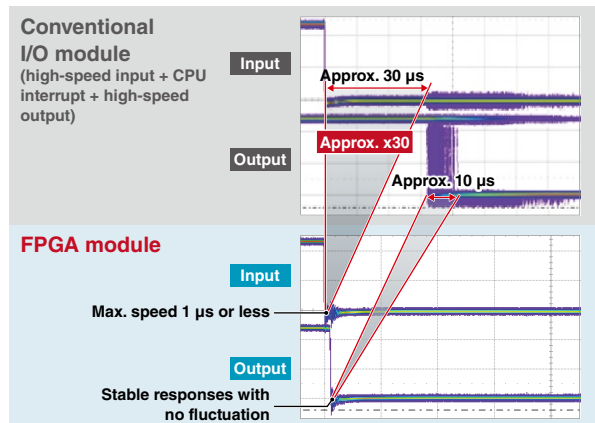

## FPGA engineering time reduction

- Dedicated boards such as FPGA boards and microcomputer boards require designing and verification of interface circuits for external devices connected with the FPGA. While, as the FPGA module is equipped with external interface circuits (standard circuits), users can focus on designing and verification of a user circuit
- The user circuit includes a sample circuit which can be used for connection with the external interface circuits. This reduces the working hours required for FPGA development

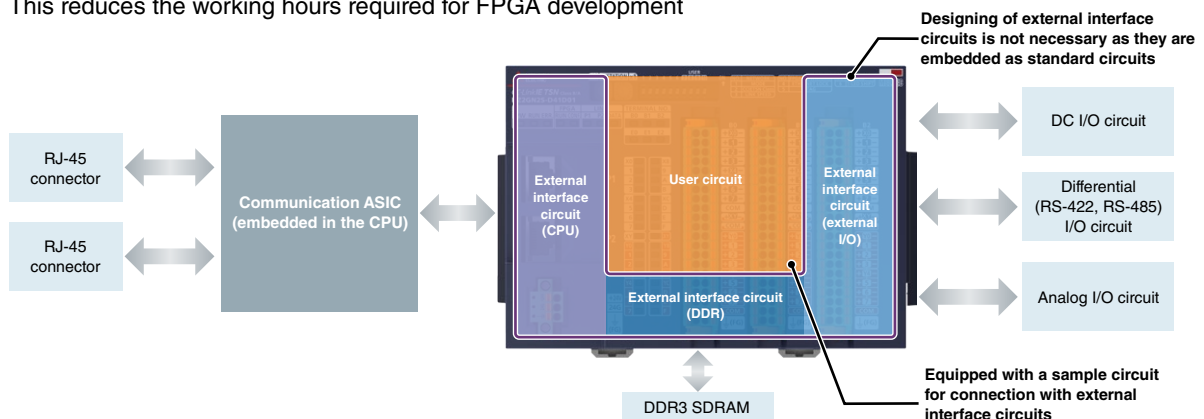

## CC-Link IE TSN-compatible FPGA module specifications

### Main module

Item		NZ2GN2S-D41P01	NZ2GN2S-D41D01	NZ2GN2S-D41PD02
Communication specifications				
CC-Link IE TSN	Station type	Remote station		
	Certified class	B/A		
	Remote input (RX), Remote output (RY)	112 points		
	Remote register (RWr/RWw)	144 points		
FTP transfer (client)	FTP server software for operation check	Microsoft® IIS		
	Number of settable transfer destinations	1 maximum		
Simple CPU communication*1		●		
Communication speed (bps)		1G/100M		
Communication cable	1 Gbps	Ethernet cable (Category 5e or higher)		
	100 Mbps	Ethernet cable (Category 5 or higher)		
FPGA specifications				
Embedded FPGA	Device name	5CGXFC7D6F2717N (Cyclone® V series manufactured by Intel)		
	Circuit capacity	Number of LEs = 149.5k (650k gates), Block RAM = 7000 kbits		
Available capacity for user (recommended value)*2		Number of LEs = 35k (150k gates), Block RAM = 4400 kbits		
FPGA system clock		100 MHz		
I/O specifications				
External interface		Spring-clamp terminal block		
Number of points	24 V DC input	48 (4 points/common, positive/negative common shared)	-	32 (4 points/common, positive/negative common shared)
	5...24 V DC output	48 (4 points/common, sink, 0.1 A/point)	-	32 (4 points/common, sink, 0.1 A/point)
	Differential (RS-422) input	-	24	8
	Differential (RS-422) output	-	24	8
	Differential (RS-485) I/O	-	3	1
Pulse speed (maximum) (pulse/s)	24 V DC input	200k (200 kHz)	-	200k (200 kHz)
	5...24 V DC output	200k (200 kHz)	-	200k (200 kHz)
	Differential (RS-422) input (multiple of 4)	-	10M	10M
	Differential (RS-422) output (multiple of 4)	-	10M	10M
	Differential (RS-485) I/O (multiple of 2)	-	5M	5M

\*1. For the list of connectable devices supporting simple CPU communication function, please see the link below.

[www.MitsubishiElectric.com/fa/ref/ref.html?k=plcr&pmerit=simple\\_cpu\\_com](http://www.MitsubishiElectric.com/fa/ref/ref.html?k=plcr&pmerit=simple_cpu_com)

\*2. If Timing Violation occurs in the logic synthesis result, review the user circuit.

### Extension modules

The extension modules increase the number of input/output points of the main modules. The number of connectable module is one. The extension modules can be controlled from the FPGA embedded in the main module.

Item		NZ2EX2S-D41P01	NZ2EX2S-D41D01	NZ2EX2S-D41A01	
I/O specifications					
External interface		Spring-clamp terminal block			
Number of points	24 V DC input	48 (4 points/common, positive/negative common shared)	-	-	
	5...24 V DC output	48 (4 points/common, sink, 0.1 A/points)	-	-	
	Differential (RS-422) input	-	24	-	
	Differential (RS-422) output	-	24	-	
	Differential (RS-485) I/O	-	3	-	
Pulse speed (maximum) (pulse/s)	Analog input	-	-	36	
	Analog output	-	-	6	
	24 V DC input	200k (200 kHz)	-	-	
	5...24 V DC output	200k (200 kHz)	-	-	
	Differential (RS-422) input (multiple of 4)	-	10M	-	
Analog input	Differential (RS-422) output (multiple of 4)	-	10M	-	
	Differential (RS-485) I/O (multiple of 2)	-	5M	-	
Analog input	Input range	Voltage	-	-9.9...9.9 V DC (input resistance: 800 kΩ or more)	
		Current	-	-19.8...19.8 mA DC (input resistance: 125 Ω ±0.1 %)	
	Digital output (bit)	-	-	16-bit signed binary (-32768...32767)	
	Conversion accuracy	Voltage	-	-	Within ±0.2 % (0...55 °C)
		Current	-	-	Within ±0.3 % (0...55 °C)
	Sampling cycle (maximum speed)	-	-	-	4 μs/36 CH
Analog output	Output range	Voltage	-	-9.9...9.9 V DC (external load resistance: 1 kΩ...1 MΩ)	
		Current	-	-	0.2...19.8 mA DC (external load resistance: 50 Ω...600 Ω)
	Digital input (bit)	-	-	-	16-bit signed binary (0...65535)
	Conversion accuracy	Voltage	-	-	Within ±0.2 % (0...55 °C)
		Current	-	-	Within ±0.3 % (0...55 °C)
	Conversion speed (maximum speed)	-	-	-	6 μs/6 CH

CPU

I/O

Analog/  
temperature input/  
temperature control

Motion/  
positioning

High-speed counter/  
isolated pulse/  
flexible high-speed I/O

FPGA

Network

Advanced  
Information

Energy  
measuring

Software

# Network module

The network module lineup fulfills new needs for industrial networks: system-wide optimization including high-speed control, large capacity data management, flexible wiring, and easier setup/maintenance required in manufacturing.

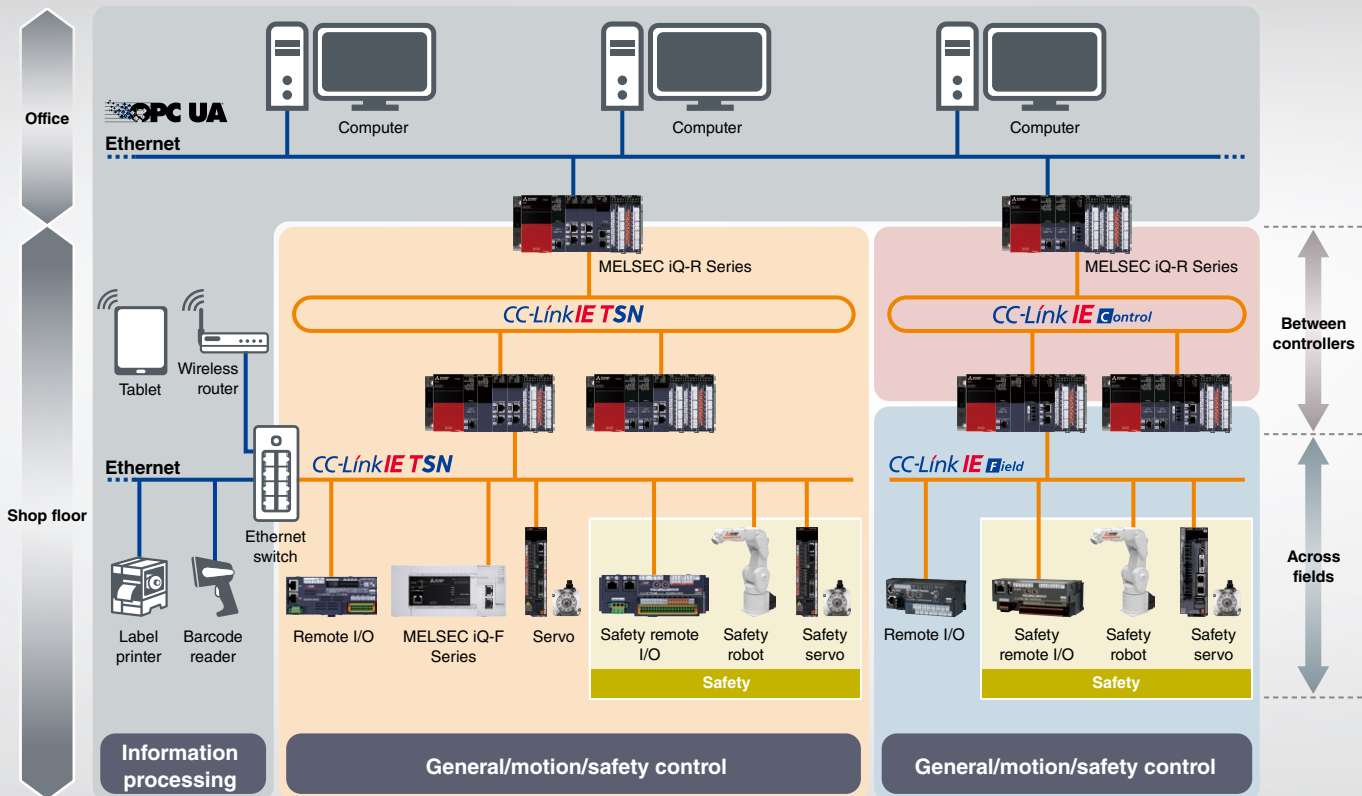

## CC-Link IE TSN

### Open integrated networking across the manufacturing enterprise

- Integrates IT system information communications and real time control communications on the same network
- Highly accurate time synchronization within  $\pm 1 \mu\text{s}$  is possible between connected stations, allowing precise time-series analysis when an error occurs
- High-precision motion control with minimum communication cycle time of just  $31.25 \mu\text{s}^*$

\*1. This value is achieved when fast operation mode of the motion module (RD78GH) is used. For details, please refer to the MELSEC IQ-R Motion Module User's Manual (Application) (IB-0300411ENG).

## CC-Link IE Control

### High-speed, large-capacity, and highly-reliable distributed control network for controllers

- Realizes 128K word (maximum link points) large data bandwidth and 1 Gbps high-speed communication
- Multi-functions such as dual-loop optical network and external power supply enable highly-reliable distributed control system

## CC-Link IE Field

### Field network realizing highly-flexible wiring

- Enables safety control and motion control as well as communications between multiple controllers and I/O control
- Realizes flexible wiring topologies according to the layout of production lines, equipment, and devices

For further details, please refer to the catalogs below.  
 "CC-Link IE TSN Product Catalog (L(NA)08656ENG)"  
 "Ethernet-based Open Network CC-Link IE Product Catalog (L(NA)08111E)"  
 "Open Field Network CC-Link Compatible Product Catalog (L(NA)08038E)"

## Network features

Networks best for each application can be selected.\*1

Item		CC-Link IE TSN	CC-Link IE Control		CC-Link IE Field
Communication cable		Ethernet cable	Ethernet cable	Optical fiber cable	Ethernet cable
Main applications	Between controllers	●		●	●
	Across fields	General control	●	-	●
		Motion control	●	-	●
		Safety control	●	-	●
Transmission speed		1 Gbps/100 Mbps	1 Gbps		1 Gbps
Max. number of connectable stations		121*2	120		121*2
Mixed TCP/IP communication		●	-		-
Maximum link points per network	Remote input (RX), remote output (RY)	16384 points, 2KB	-		16384 points, 2KB
	Remote register (RWw, RWr)	8192 points, 16KB	-		8192 points, 16KB
	Link relay (LB)	32768 points, 4 KB For extended points: 131072 points, 16 KB	32768 points, 4KB For extended points: 65536 points, 8KB		-
	Link register (LW)	16384 points, 32 KB For extended points: 524288 points, 1024 KB	131072 points, 256KB For extended points: 262144 points, 512KB		-
	Link input (LX), link output (LY)	-	8192 points, 1KB		-
Max. station-to-station distance		100 m	100 m	550 m	100 m
Network topology/overall cable distance	Line	12000 m	11900 m	-	12000 m
	Ring	12100 m	12000 m	66000 m	12100 m
	Star	Depends on the system configuration	Depends on the system configuration	-	Depends on the system configuration
	Line and star combination	Depends on the system configuration	Depends on the system configuration	-	Depends on the system configuration

\*1. For more information about performance specifications of modules, please refer to relevant product manuals.  
 \*2. Includes a master station.

## Other networks

In addition to CC-Link IE-based networks, various networks are supported.

CC-Link AnyWire ASLINK MELSECNET/H

The lineup also includes modules that support other open networks.

■ Ethernet-based network

BACnet®  
EtherNet/IP™

■ Serial-based network

CANopen® PROFIBUS® MODBUS®  
DeviceNet® PROFINET®

■ Others

IO-Link  
GP-IB

CPU  
I/O  
Analog/temperature input/temperature control  
Motion/positioning  
High-speed counter/isolated pulse/flexible high-speed I/O  
FPGA  
Network  
Advanced information  
Energy measuring  
Software

## CC-Link IE TSN master/local module

Control communication requiring real-time performance and TCP/IP communication can be mixed, maximizing CC-Link IE TSN performance and functionality.

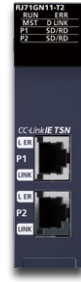

RJ71GN11-T2

RJ71GN11-T2  
**CC-Link IE TSN**

### Deterministic control even when mixed with TCP/IP communication

Mixed TCP/IP communication

IIoT system

- Deterministic performance of cyclic communication is maintained even when mixed with slower information data (non real-time)
- TCP/IP communication devices can be used without affecting overall control

\*Some devices cannot be connected to CC-Link IE TSN depending on the system configuration.

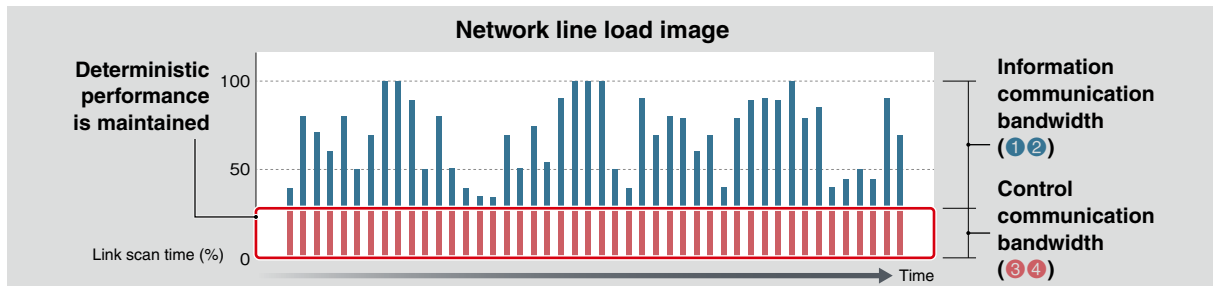
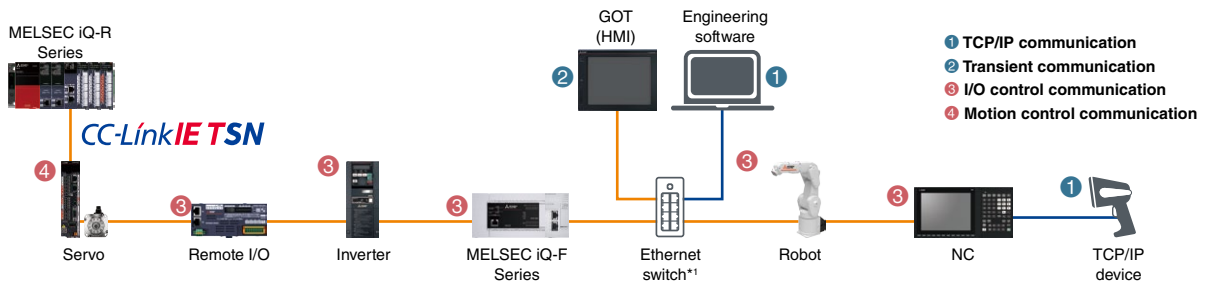

\*1. Class B managed Ethernet switch supporting CC-Link IE TSN recommended by the CC-Link Partner Association

### Error cause analysis with highly precise time synchronization

Time-series analysis

Synchronized communication

- Highly accurate time synchronization accuracy within  $\pm 1 \mu s$  and each station connected to the network sharing time-stamp information in 1 ms increments improves system diagnostics and troubleshooting by enabling sequential analysis of stations in the network
- The error history is displayed consecutively based on time-stamp data, enabling accurate analysis of the cause of error using the actual time the event occurred

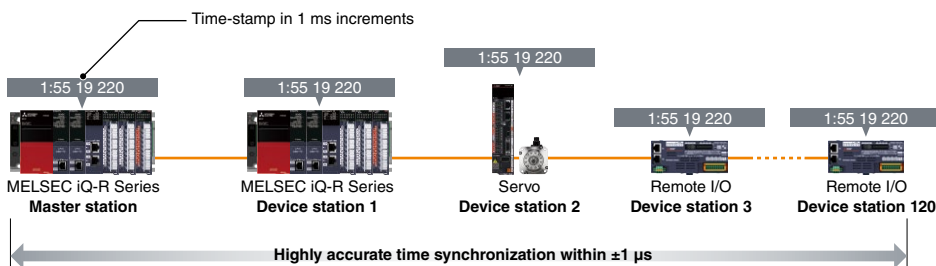

## Reducing overall operating time with high-speed link scan

Min. communication cycle **31.25  $\mu$ s<sup>\*1</sup>**

High-speed processing **16  $\times$ <sup>\*2</sup> faster**

Link points **2  $\times$ <sup>\*3</sup>**

- The advanced protocol built into CC-Link IE TSN is complemented by the time-sharing method functionality that enables simultaneous communications between network stations
- Fast communication cycle time of just 31.25  $\mu$ s<sup>\*1</sup> and high-speed processing approximately 16 times faster than current network performance are achieved, resulting in high-speed and high-accuracy motion control
- Productivity is simultaneously improved owing to a substantial increase in control performance, which reduces overall operating time and enables high-speed and large capacity data communication

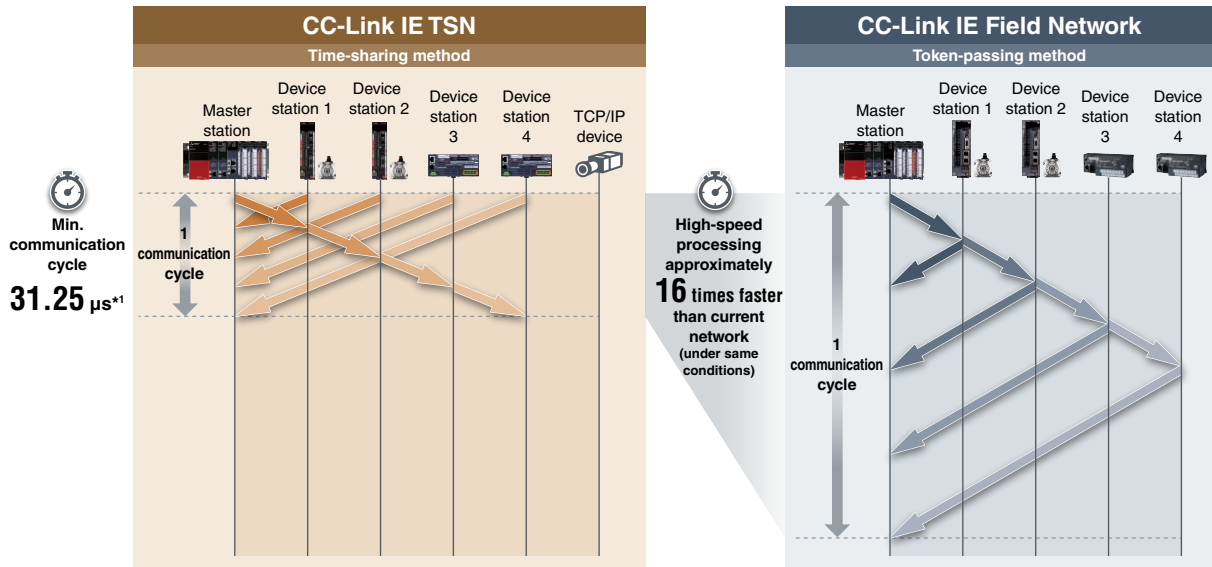

\*1. This value is achieved when fast operation mode of the motion module (RD78GH) is used. For details, please refer to the "MELSEC iQ-R Motion Module User's Manual (Application) (IB-0300411ENG)".

\*2. Comparison with CC-Link IE Field Network Motion

\*3. Comparison with CC-Link IE Field Network

CPU

I/O

Analog/  
temperature input/  
temperature control

Motion/  
positioning

High-speed counter/  
isolated pulse/  
flexible high-speed I/O

FFGA

Network

Advanced  
Information

Energy  
measuring

Software

## CC-Link IE TSN Plus master/local module

EtherNet/IP™ devices can be utilized without affecting CC-Link IE TSN performance.



### RJ71GN11-EIP CC-Link IE TSN

- Ethernet port (P1)  
CC-Link IE TSN supported
- Ethernet port (P2)  
EtherNet/IP™ supported

### Utilize other network devices

#### Utilize EtherNet/IP™ devices

- Utilize EtherNet/IP™ devices while maintaining high-speed/high-accuracy CC-Link IE TSN communication
- Both networks are easily settable within the engineering software GX Works3
- Socket communication is supported, allowing devices that do not support SLMP via general Ethernet to be connected

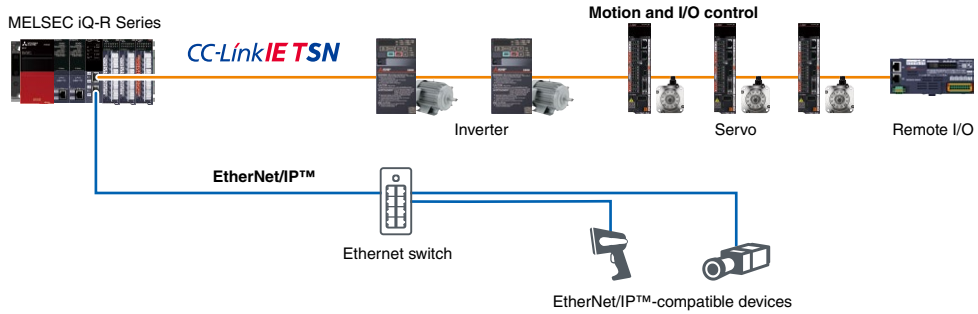



## CC-Link IE Controller Network module

A highly reliable control network designed to handle very large data communications (128K words) over a high-speed (1 Gbps) dual-loop optical cable topology.

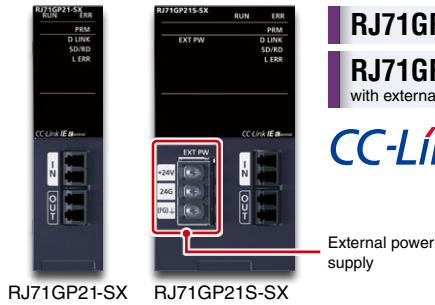

RJ71GP21-SX

RJ71GP21S-SX  
with external power supply

CC-Link IE Control

### Continuous communications even when cable or stations are faulty

Optical fiber cable

Highly reliable

- Utilizing a high-speed, noise resistant fiber-optic topology, the CC-Link IE Controller Network supports a loop-back function that guarantees continuous communications even when a cable is disconnected or a station falls into a fault status

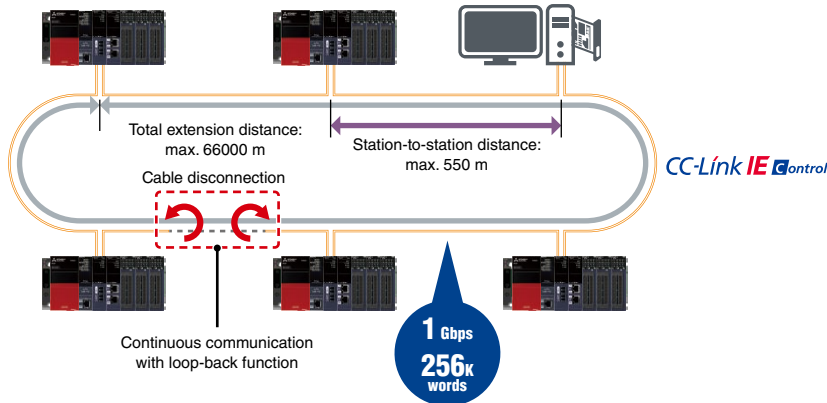

### Extensive real-time network monitoring

Easy troubleshooting

- The network status can be easily monitored directly from engineering software GX Works3 enabling intuitive troubleshooting of network errors or viewing the operation of the network while in communications
- All stations within the network can be monitored regardless of which station the software is connected too

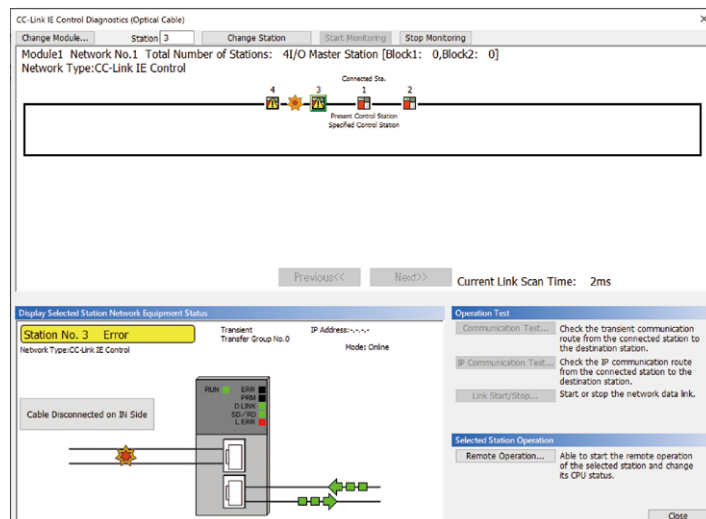

CC-Link IE Control diagnostics window

CPU

I/O

Analog/  
temperature input/  
temperature control

Motion/  
positioning

High-speed counter/  
isolated pulse/  
flexible high-speed I/O

FPGA

Network

Advanced  
information

Energy  
measuring

Software

## CC-Link IE Field Network master/local module

Flexible wiring topologies according to the layout of production lines, equipment, and devices are supported. In addition, setup and troubleshooting are easy.



RJ71GF11-T2  
**CC-Link IE Field**

### Easy setup and troubleshooting

Easy setup

Easy troubleshooting

- Just setting link device points and assignment to the master station, the setting can be automatically transferred to each local station, thereby allowing easy network setup
- Easy troubleshooting without relying on experience and knowledge is possible on the engineering software GX Works3

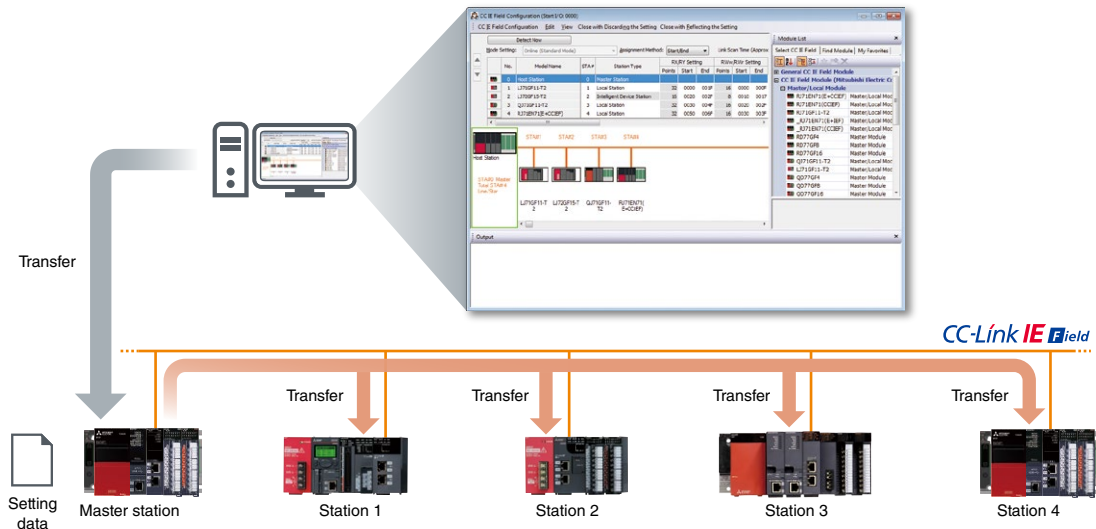

### Multiple topology variations

Flexible network

#### Star topology

Devices are connected via an Ethernet switch allowing device stations to be added easily.

#### Line topology

Continuous connection of devices along the Ethernet line, reducing wiring cost.

#### Ring topology

Connection is done in a continuous loop, which guarantees communications by isolating the faulty network station.

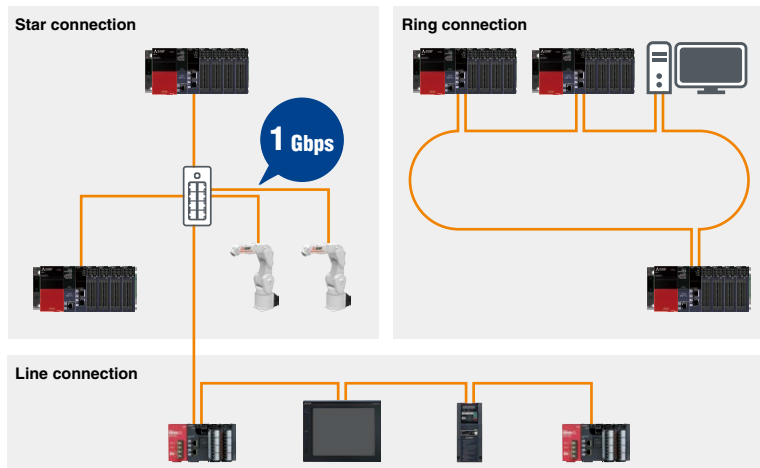

## CC-Link IE Field Network remote head module

The remote head module installed in the CPU slot can control modules on the base unit via network.



RJ72GF15-T2  
CC-Link IE Field

### Highly reliable distributed control and redundant system

Reduced wiring

Highly reliable

- Wiring and space saving distributed control system can be achieved
- Installing redundant head modules and redundant network cables ensure continuous communication; even if an error occurs in one of the head modules, the network standby module can take over without disrupting network communications and initiate the control system to switch to the standby system

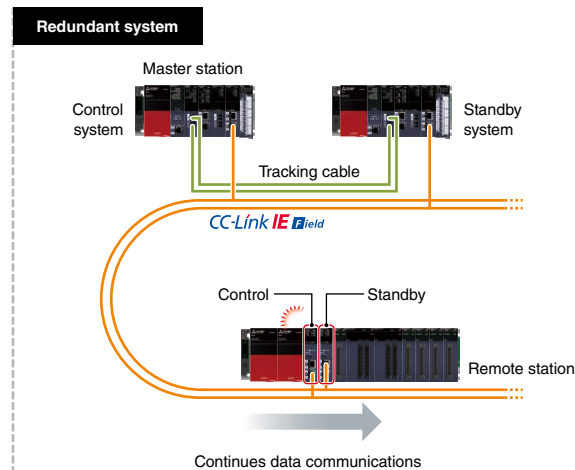
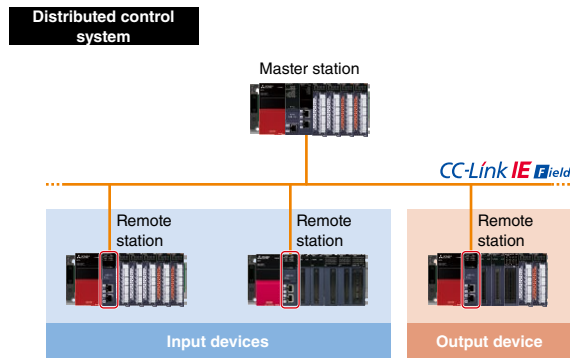

\*The module within the red box is CC-Link IE Field Network remote head module (RJ72GF15-T2).

## CC-Link system master/local module

The module enables high-speed transmission of bit data such as ON/OFF status and word data such as analog information between devices.



RJ61BT11  
CC-Link

### System configuration that meets control requirements

- CC-Link incorporates many different field devices that can be configured into a wire-saving communications network
- Using the remote device net mode, it is possible to connect up to 64 remote devices, such as analog I/O modules

Extensive partner devices

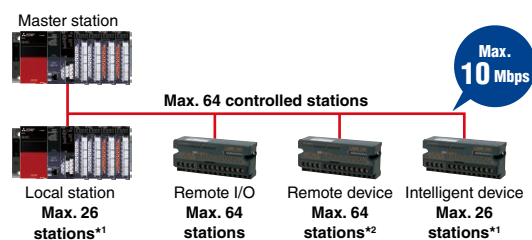

\*1. Remote net mode  
\*2. Remote device net mode

- CPU
- I/O
- Analog/temperature input/temperature control
- Motion/positioning
- High-speed counter/isolated pulse/flexible high-speed I/O
- FPGA
- Network
- Advanced information
- Energy measuring
- Software

## AnyWireASLINK master module

AnyWireASLINK system can monitor (diagnose) the network system from a centralized location, reducing commissioning time and improving productivity.



RJ51AW12AL

**AnyWireASLINK**

### Predictive maintenance by monitoring of sensor status

Diagnostics

Predictive maintenance

- The sensing level of sensors can be monitored from the programmable controller and GOT (HMI)
- Detects errors such as low sensing level and notifies the entire system before an error occurs, enabling predictive maintenance

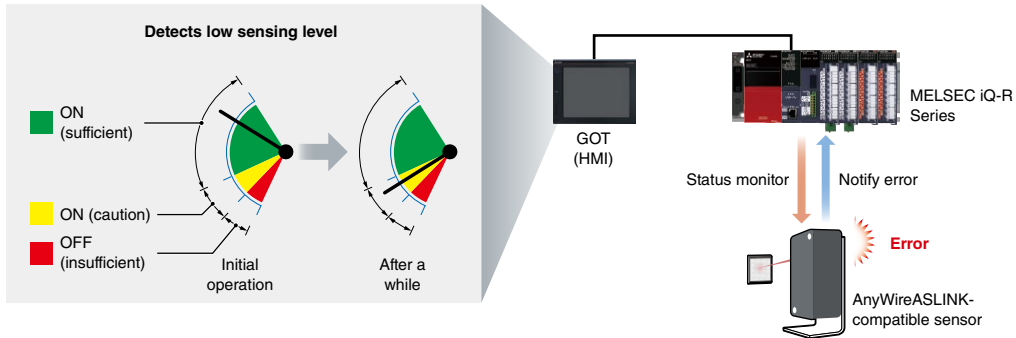

### Easy setup of sensors

Setup time reduction

- Sensor parameters can be set from the programmable controller and GOT (HMI)
- General sensors need to be adjusted one by one on the shop floor. AnyWireASLINK system allows multiple sensors to be set in batch from the programmable controller, significantly reducing sensor setup time

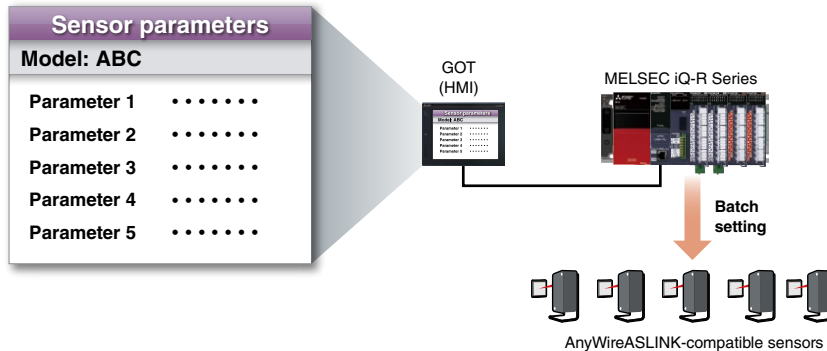

## MELSECNET/H network module (Optical loop type)

This module supports the PLC to PLC network in a MELSECNET/H network\*1.

\*1. Remote I/O network is not supported.



RJ71LP21-25  
MELSECNET/H

### Easily utilize MELSEC-Q Series programs

- MELSEC iQ-R Series modules can be added to the existing MELSECNET/H network consisting with MELSEC-Q Series modules
- A redundant system is also supported, allowing replacement of the existing MELSEC-Q Series redundant system

\*The module in the red box is the MELSECNET/H network module (RJ71LP21-25).

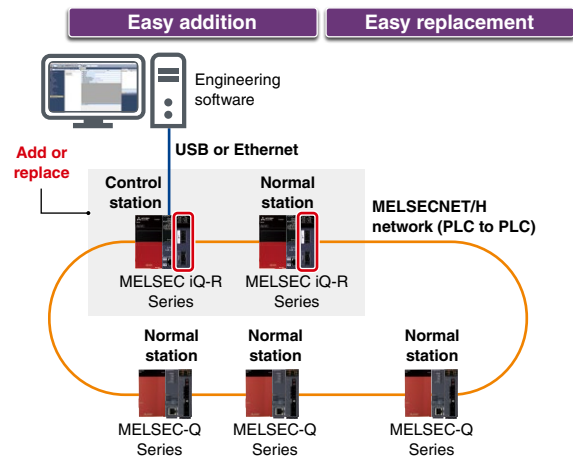

## MELSECNET/H network module (Coaxial bus type)

Coaxial bus cables are less expensive than optical fiber cables, allowing system configuration at a low cost.



RJ71BR11  
MELSECNET/H

### Easily utilize MELSEC-Q Series programs

- The MELSEC iQ-R Series modules can be added to the existing MELSECNET/H network consisting of the MELSEC-Q Series modules. Replacement is also possible

#### Coaxial bus system

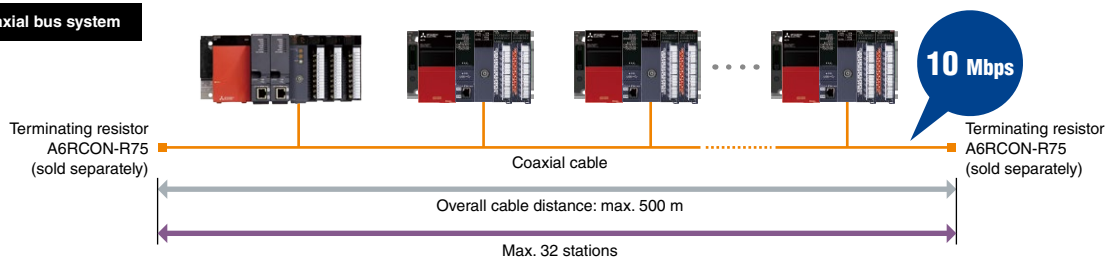

- CPU
- I/O
- Analog/temperature input/temperature control
- Motion/positioning
- High-speed counter/ isolated pulse/ flexible high-speed I/O
- FFGA
- Network
- Advanced information
- Energy measuring
- Software

Modules supporting other open networks are also available.  
 Select modules ideal for network requirements.

**Ethernet-based network-compatible modules**



**BACnet module**

RJ71BAC96

**BACnet®**



**EtherNet/IP network interface module**

RJ71EIP91

**EtherNet/IP™**



**CIP Safety module**

RJ71SEIP91-T4

**CIP Safety™**

**Serial-based network-compatible modules**



**CANopen module**

RJ71CN91

**CANopen®**



**DeviceNet master/slave module**

RJ71DN91

**DeviceNet®**



**PROFIBUS-DP module**

RJ71PB91V

**PROFIBUS®**



**PROFINET IO module**

RJ71PN92

RJ71PN93

**PROFINET®**

RJ71PN92 RJ71PN93

**Another network-compatible module**



**GP-IB interface module**

RJ71GB91

**GP-IB**

## Ethernet interface module

The module is equipped with two ports that can be used as either a general Ethernet, CC-Link IE Controller Network (twisted-pair cable), or CC-Link IE Field Network.



RJ71EN71

CC-Link IE Control  
CC-Link IE Field

Ethernet port (P1)  
Ethernet port (P2)

## Easy data sharing with third-party programmable controllers without programs

### Communication without a program

The Ethernet interface module allows device data exchange by parameter registration with Mitsubishi Electric programmable controllers as well as third-party programmable controllers (simple CPU communication function)\*1

Data collection is easier without changing programs of the existing programmable controllers

\*1. For the list of connectable devices, please see the link below.  
[www.MitsubishiElectric.com/fa/ref/ref.html?k=plcr&pmerit=simple\\_cpu\\_com](http://www.MitsubishiElectric.com/fa/ref/ref.html?k=plcr&pmerit=simple_cpu_com)

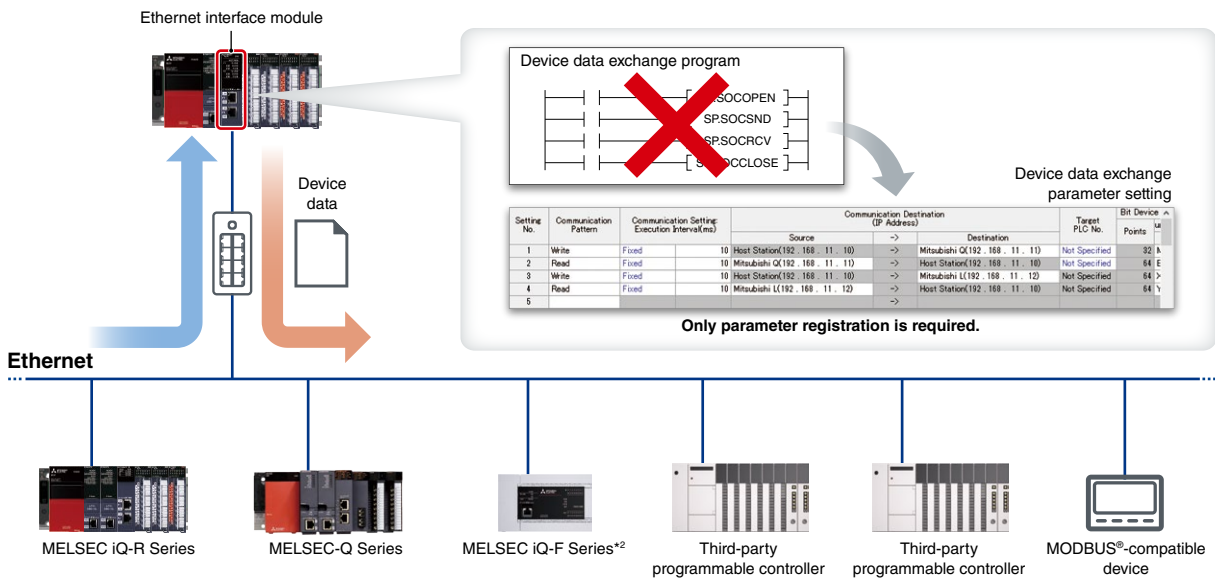

\*2. Supported by the embedded Ethernet port only.

## Dual Ethernet ports support two networks

### Multiple network compatibility

Equipped with two Ethernet ports, the module enables Ethernet, CC-Link IE Controller Network, and CC-Link IE Field Network communications. Different networks can be simultaneously connected to the two Ethernet ports

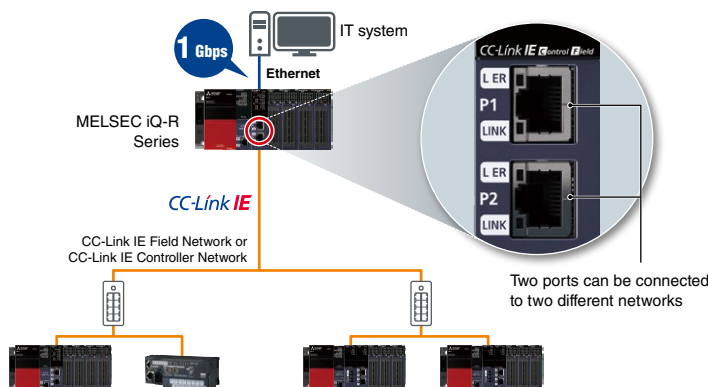

Select network combination from within GX Works3.

■ Network combination\*3

P1	C	F	E	E	E
P2	C	F	C	F	E

C : CC-Link IE Controller Network

F : CC-Link IE Field Network

E : Ethernet

\*3. The CC-Link IE Field and CC-Link IE Controller Networks cannot be used together.

CPU

I/O

Analog/temperature input/temperature control

Motion/positioning

High-speed counter/ isolated pulse/ flexible high-speed I/O

FFGA

Network

Advanced information

Energy measuring

Software

### Access to third-party devices' information (memory area)

#### Communication without a program

- Simple device communication function enables communication not only with Mitsubishi Electric devices but also with third-party devices (robots, temperature controllers, etc.) to obtain various information such as operation and diagnostic information
- Reads/writes necessary data in the target device by simply selecting a command. This is useful when accessing the proprietary data in a specific device

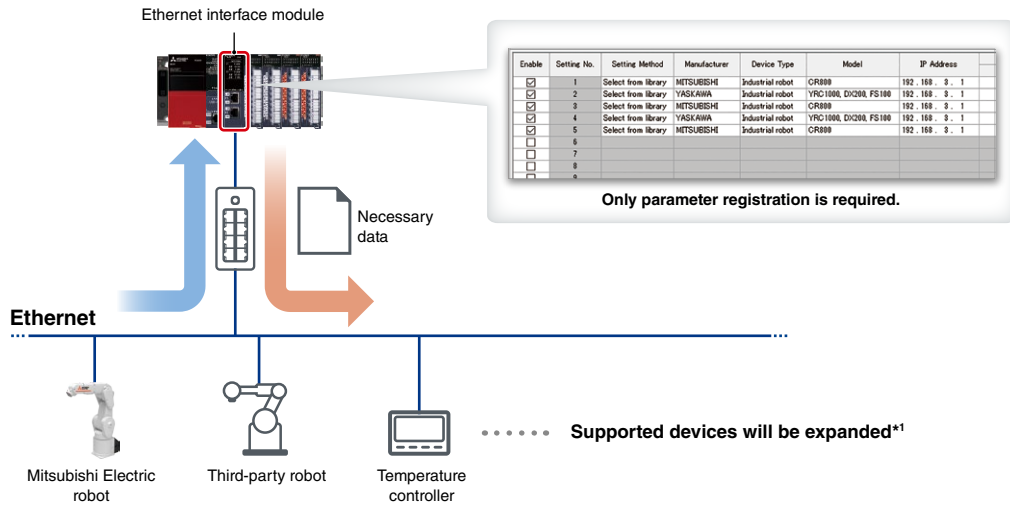

\*1. For details on compatible devices, please refer to the "MELSEC iQ-R Simple Device Communication Library Reference Manual (SH-082515ENG)".

## Serial communication module

Simply selecting from the communication protocol library in the engineering software GX Works3, data communication supporting general-purpose protocols such as MODBUS® is easily performed.



RJ71C24

### RJ71C24

RS-232: 1-channel, RS-422/485: 1-channel

### RJ71C24-R2

RS-232: 2-channel

### RJ71C24-R4

RS-422/485: 2-channel

**MODBUS®**

### Data collection from the existing MELSEC-A Series and MODBUS®-compatible devices

- Just by registering parameters, easy device data exchange with the existing MELSEC-A Series and MODBUS®-compatible devices is possible
- Simply installing the MELSEC iQ-R Series for data collection enables data collection from the existing MELSEC-A Series easily

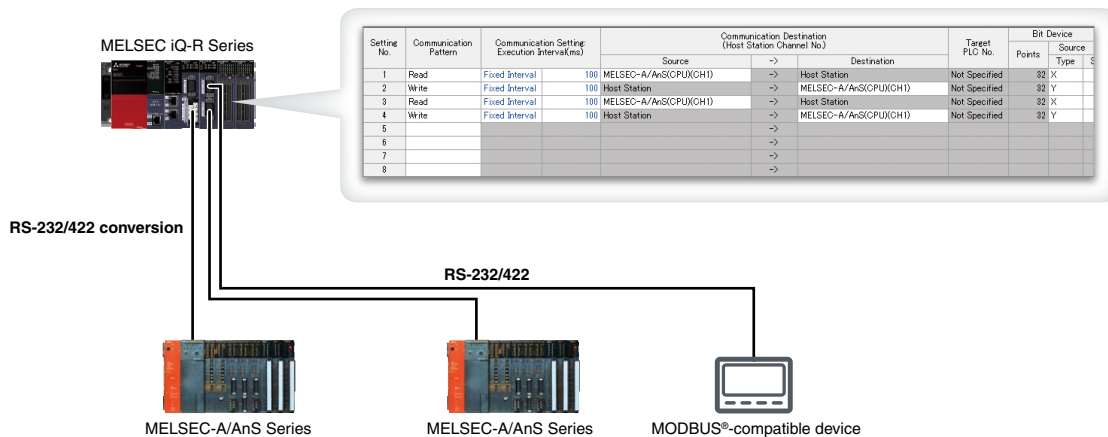



**CC-Link IE TSN master/local module, CC-Link IE TSN Plus master/local module  
CC-Link IE Field Network master/local module, CC-Link system master/local module specifications**

Item	RJ71GN11-T2*1	RJ71GN11-EIP	RJ71GF11-T2	RJ61BT11
Compatible network	CC-Link IE TSN	CC-Link IE TSN EtherNet/IP™	CC-Link IE Field	CC-Link
Communication speed (bps)	1G/100M	1G/100M	1G	156k/625k/2.5M/ 5M/10M
Maximum stations per network*2	121	121	121	65
Network topology*3	Line, star*4, ring	Line*5, star*4	Line, star*4, ring	Bus (RS-485)
Connection cable	Ethernet cable (Category 5e or higher)	Ethernet cable (Category 5e or higher)	Ethernet cable (Category 5e or higher)	Ver. 1.10-compatible CC-Link dedicated cable
Max. station-to-station distance (m)	100	100	100	-
Overall cable distance (m)	Line: 12000 Ring: 12100 Others: depends on the system configuration	Line: 12000 Others: depends on the system configuration	Line: 12000 Star: depends on the system configuration*6 Ring: 12100	100 (10 Mbps)... 1200 (156 kbps)
<b>Maximum link points per network</b>				
Remote input (RX), remote output (RY)	16384 points, 2KB	16384 points, 2KB	16384 points, 2KB	8192 points
Remote register (RWr, RWw)	8192 points, 16KB	8192 points, 16KB	8192 points, 16KB	2048 points
Link relay (LB)	32768 points, 4 KB For extended points: 131072 points, 16 KB	32768 points, 4 KB For extended points: 131072 points, 16 KB	-	-
Link register (LW)	16384 points, 32 KB For extended points: 524288 points, 1024 KB	16384 points, 32 KB For extended points: 524288 points, 1024 KB	-	-
<b>EtherNet/IP™ communications</b>				
Data transmission speed (bps)	-	1G/100M	-	-
Class 1 communications	Number of connections	-	• Instance communications: 256*7 • Tag communications: 256*7	-
	Communication data size (byte)	-	1444 (per connection)*8	-
	RPI (communication cycle) (ms)	-	0.5...60000 (in increments of 0.5 ms)	-
	PPS (communication processing performance)*9 (pps)	-	12000	-
UCMM communications	Number of connections (number of simultaneous executions)	-	• Server: 96*7*10 • Client: 32	-
	Communication data size (byte)	-	• Message communications: 504 (including headers) • Tag communications: 498	-
Class 3 communications	Number of connections	-	• Server: 96*7*10 • Client: 256*7	-
	Communication data size (byte)	-	• Message communications: 1404 (per connection) • Tag communications: 496 (per connection)	-

\*1. For restrictions on the system configuration, please check the "MELSEC iQ-R CC-Link IE TSN User's Manual (Startup) (SH-082127ENG)".  
 \*2. Includes a master station.  
 \*3. Please use a managed Ethernet switch supporting CC-Link IE TSN (class B) recommended by the CC-Link Partner Association for the CC-Link IE TSN master/local module (RJ71GN11-T2) and CC-Link IE TSN Plus master/local module (RJ71GN11-EIP).  
 \*4. Line topology and star topology can be mixed.  
 \*5. The CC-Link IE TSN Plus master/local module (RJ71GN11-EIP) can only be connected at the end of the network.  
 \*6. An Ethernet switch is required for a star connection. Up to 20 Ethernet switches can be connected.  
 \*7. The total number of connections for Class 1 communications, UCMM tag communications (server function), and Class 3 communications is 256. Therefore, the number of each connection varies depending on the number and size of separate communications.  
 \*8. If the external device does not support Large Forward Open (CIP option specifications), the communication data size is up to 504 bytes.  
 \*9. PPS: Number of frames that can be processed per second  
 \*10. The maximum number of simultaneous executions (the number of connections that can be received simultaneously) for the server function is 96 for the total of UCMM and Class 3 communications server functions.

CPU

I/O

Analog/temperature input/temperature control

Motion/positioning

High-speed counter/ isolated pulse/ flexible high-speed I/O

FFGA

Network

Advanced information

Energy measuring

Software

**CC-Link IE Controller Network module, MELSECNET/H network module specifications**

Item	RJ71GP21-SX/RJ71GP21S-SX	RJ71LP21-25	RJ71BR11
Compatible network	CC-Link IE Control	MELSECNET/H	MELSECNET/H
Communication speed (bps)	1G	25M/10M (MELSECNET/10 mode: 10M)	10M
Maximum stations per network	120	64	32
Network topology	Duplex loop	Duplex loop	Single bus
Connection cable	Optical fiber cable	Optical fiber cable	Coaxial cable
Max. station-to-station distance (m)	550	10 Mbps: 500 (SI optical fiber cable) 1000 (H-PCF/broadband H-PCF/QSI/ broadband silica glass optical fiber cable)	3C-2V: 300 5C-2V: 500 5C-FB, S-5C-FB: 500
Overall cable distance (m)	66000 (when 120 stations are connected)	30000	3C-2V: 300 5C-2V: 500 5C-FB, S-5C-FB: 500 Can be extended up to 2.5 km with a repeater unit (A6BR10, A6BR10-DC)
Maximum link points per network			
Link relay (LB)	32768 points, 4KB For extended points: 65536 points, 8KB	16384 points (MELSECNET/10 mode: 8192 points)	16384 points (MELSECNET/10 mode: 8192 points)
Link register (LW)	131072 points, 256KB For extended points: 262144 points, 512KB	16384 points (MELSECNET/10 mode: 8192 points)	16384 points (MELSECNET/10 mode: 8192 points)
Link input (LX), link output (LY)	8192 points, 1KB	8192 points	8192 points

**CC-Link IE Field Network remote head module specifications**

Item	RJ72GF15-T2
Transmission speed (bps)	1G
Network topology	Line, star (both types can be on the same line), ring
Connection cable	Ethernet cable (Category 5e or higher, double shielded/STP)
Max. station-to-station distance (m)	100
Overall cable distance (m)	Line: 12000 (when 121 stations are connected) Star: Depends on the system configuration Ring: 12100 (when 121 stations are connected)
SIL 2-supporting	●*1
Max. number of link points per network	
Remote input (RX), remote output (RY)	2048 points, 256B
Remote register (RWr, RWw)	1024 points, 2KB

\*1. Used when the SIL 2-supporting redundant system is configured.

**AnyWireASLINK master module specifications**

Item	RJ51AW12AL
Number of bit data points (bit)	Max. 512 (input: 256/output: 256)
Number of connectable units	Max. 128 (varies according to each remote unit's current consumption)
Maximum total wiring length (m)	200*2
Topology	Bus (multi-drop, T-branch, tree branch, and star wiring)
Transmission clock (Hz)	27.0k
Max. transmission cable supply current*3 (A)	2.0 (when 1.25 mm <sup>2</sup> cable is used) 1.2 (when 0.75 mm <sup>2</sup> cable is used)

\*2. For remote modules with transmission cables (DP, DN), the length of the transmission cables (DP, DN) is included in the total wiring length.

\*3. The maximum value may vary depending on the overall cable length. For details, please refer to the user's manuals.

### BACnet module specifications

Item	RJ71BAC96
Transmission specifications	
Transmission rate (bps)	100M/10M
Communication mode	Full-duplex/half-duplex
Transmission method	Base band
Maximum segment length (m)	100 (distance between switching hub and node)
IP version	IPv6/IPv4

### EtherNet/IP network interface module specifications

Item	RJ71EIP91
Class 1 communications	
Communication format	Standard EtherNet/IP™, tag communications
Number of connections*1	Standard EtherNet/IP™: 256, Tag communications: 256
Communication data size (byte)	1444 (per connection)
Connection type	Point-to-point, multicast
RPI (communication cycle) (ms)	0.5...60000
Class 3 communications	
Communication format	Standard EtherNet/IP™
Number of connections	Server: 256*1, Client: None
Communication data size (byte)	1414 (per connection)
Connection type	Point-to-point
UCMM communications	
Communication format	Standard EtherNet/IP™
Number of connections (number of simultaneous executions)	Server: 96, Client: 32
Communication data size (byte)	1414
Connection type	Point-to-point

\*1. The total number of connections for Class 1 and Class 3 communications is 256.

### CIP Safety module specifications

Item	RJ71SEIP91-T4
Class 1 communications	
Communication format	Standard EtherNet/IP™, tag communications
Number of connections*2	128 (Standard EtherNet/IP™ + tag communications)
Communication data size (byte)	1444 (per connection)
Connection type	Point-to-point, multicast
RPI (communication cycle) (ms)	1...60000
Class 0 communications	
Communication format	CIP Safety over EtherNet/IP™
Number of connections	Consumer: 120*3, producer: 120*3
Communication data size (byte)	14 (per connection)
Connection type	Point-to-point, multicast
RPI (communication cycle) (ms)	4...1000
UCMM communications	
Communication format	Standard EtherNet/IP™
Number of connections (number of simultaneous executions)	Server: 32, client: 32
Communication data size (byte)	504
Connection type	Point-to-point
Other	
Topology	Line, star, ring (The module can operate as a ring node and ring supervisor)*4

\*2. The maximum number of connections per port is 64.

\*3. For the CIP Safety module with the firmware version "01", the number of connections is 60.

\*4. For the CIP Safety module with the firmware version "01", the module can operate as a ring node only.

### CANopen module specifications

Item	RJ71CN91
Transmission type	CAN bus network (RS-485, CSMA/CR)
Supported network protocol	CANopen®, CAN
Supported communication service*5	CiA®-301 V4.2, CiA®-302 V4.1, CiA®-305 V2.2
Supported device/application profile*5	CiA®-405 V2.0 (Interface and device profile for IEC 61131-3 programmable devices)
Remote transmit request (RTR)	CANopen® 405 mode: Not supported for PDO 11-bit CAN-ID Layer 2 message mode and 29-bit CAN-ID Layer 2 message mode: Supported
Communication data size (CANopen®405 mode)	4 words x 256 (TPDO), 4 words x 256 (RPDO)
Selectable Node ID	1...127
Communication method	Acyclic, cyclic, or event-driven
Transmission speed (bps)	1M/800k/500k/250k/125k/100k/50k/20k/10k
Maximum cable length (m)	5000 (10 kbps), 2500 (20 kbps), 1000 (50 kbps), 600 (100 kbps), 500 (125 kbps), 250 (250 kbps), 100 (500 kbps), 50 (800 kbps), 25 (1 Mbps)
Interface	Two-piece pluggable terminal block
Setup software	
CANopen configuration tool	SW1DNN-CANOPCT-BD*6

\*5. Compliant with CiA® standards.

\*6. To obtain the software, please contact your local Mitsubishi Electric office or representative.

CPU

I/O

Analog/temperature input/temperature control

Motion/positioning

High-speed counter/ isolated pulse/ flexible high-speed I/O

FFGA

Network

Advanced information

Energy measuring

Software

### DeviceNet master/slave module specifications

Item	RJ71DN91
Operation mode	Master, slave, master/slave combined
Settable station number	0...63
Transmission speed (baud)	125k, 250k, 500k
<b>Master functions</b>	
Node type	DeviceNet® master (Group2 only client)
Max. number of message connections	63
Max. message communication data size (byte)	240 (each for transmit/receive)
I/O connection type	Polling, bit-strobe, change-of-state (COS), cyclic
Max. I/O communication data size (byte)	512 (each for transmit/receive, max. 256 per station)
<b>Slave functions</b>	
Node type	DeviceNet® slave (Group2 server)
I/O connection type	Polling
Max. I/O communication data size (byte)	128 (each for transmit/receive)

### PROFIBUS-DP module specifications

Item	RJ71PB91V	
PROFIBUS-DP station type	Class 1 master or slave station (either one can be selected)	
Transmission speed (bps)	9.6k...12M	
Max. number of connectable modules (per segment)	32 (including master stations, slave stations, and repeaters)	
Max. number of connectable modules (per network)	126 (including master and slave stations)	
<b>I/O data size</b>		
Master station	Max. input data (byte)	8192 (max. 244 per slave station)
	Max. output data (byte)	8192 (max. 244 per slave station)
Slave station	Max. input data (byte)	244 (total I/O data: max. 384)
	Max. output data (byte)	244 (total I/O data: max. 384)
<b>Setup software</b>		
PROFIBUS configuration tool	SW1DNN-PROFIBDCT-ED*1	

\*1. To obtain the software, please contact your local Mitsubishi Electric office or representative.

### PROFINET IO Controller module specifications

Item	RJ71PN92
<b>Data exchange</b>	
Maximum input data length per network (word)	4096
Maximum output data length per network (word)	4096
Maximum input data length per IO device (byte)	1437
Maximum output data length per IO device (byte)	1437
Cycle time (ms)	512 (max.), 1 (min.)*2
<b>Service interface</b>	
Maximum transmission capacity per request (byte)	4116
Maximum number of connectable IO devices	128
Data transmission speed*3 (bps)	1G/100M/10M

\*2. The cycle time depends on the number of IO devices and the input/output data length.

\*3. Data communications at 100 Mbps is recommended.

### PROFINET IO Device module specifications

Item	RJ71PN93
<b>Data exchange</b>	
Maximum I/O data length (byte)	1024 (total size of the I/O data)*4
Cycle time (ms)	512 (max.), 2 (min.)
<b>Other</b>	
PROFINET® communication specifications	Conformance class B
MRP (Media Redundancy Protocol)	MRC*5
Data transmission speed*6 (bps)	100M/10M

\*4. For details on I/O data, please refer to the "MELSEC iQ-R PROFINET IO Device Module User's Manual (Application) (SH-082366ENG)".

\*5. The RJ71PN93 operates as an MRC in a ring topology. To perform communications in the ring topology, a device in the ring topology has to operate as the MRM (Media Redundancy Manager).

\*6. Data communications at 100 Mbps is recommended.

**GP-IB interface module specifications**

Item	RJ71GB91
Transmission method	8 bits parallel transmission
Interface	IEEE 488.1 compliant
Network topology	Star topology, daisy chain topology
Cable length	2 m or less per interface module (overall cable distance: 20 m) Max. 4 m when used for one to one connection
Max. number of connectable devices	15 (includes GP-IB interface module)
Max. number of data that can be sent/received at a time (byte)	32360 (send) 32360 (receive)
Max. data transfer speed (per second)	The transfer speed of the slowest device among the connected devices 100 KB (when one device is connected to one GP-IB interface module)

**Ethernet interface module specifications**

Item	RJ71EN71**
Transmission specifications	
Data transmission speed (bps)	1G/100M/10M
Interface	RJ45 connector (Auto MDI/MDI-X)
Max. frame size (byte)	1518/9022 (when jumbo frames are used)
IP version	Compatible with IPv4
Sending/receiving data storage memory	
Number of simultaneous open connections	128
Fixed buffer	5K words x 16 (only P1 can be used)
Socket communications	5K words x 48 (when only P1 is used), 5K words x 112 (when only P1/P2 is used)
Random access buffer	6K words x 1
Simple CPU communication	●
MODBUS®/TCP communication	●*2
CC-Link IE Field/Controller Network cable specifications	
Connection cable	Ethernet cable (Category 5e or higher, double shielded/STP)

\*1. The specifications differ for the MELSEC-Q Series-compatible Ethernet mode.

\*2. The MODBUS®/TCP master function is supported when used with the simple CPU communication function or predefined protocol support function.

**Serial communication module specifications**

Item	RJ71C24	RJ71C24-R2	RJ71C24-R4
Transmission speed (bps)	1.2k/2.4k/4.8k/9.6k/14.4k/19.2k/28.8k/38.4k/57.6k/115.2k/230.4k		
MODBUS® communication function	●*3		
Interface			
CH1	RS-232	RS-232	RS-422/485
CH2	RS-422/485	RS-232	RS-422/485
Overall transmission distance			
RS-232 (m)	15	15	-
RS-422/485 (m)	1200	-	1200
Function			
Simple CPU communication	●	●	●

\*3. The MODBUS® master function is supported when used with the simple CPU communication function.



## CC-Link IE TSN-compatible block-type remote module

Block-type remote modules are recognized as device stations on the CC-Link IE TSN and used when installation requires them to be close to connected I/Os to save on wiring.



### Input, output, I/O combined module

Digital I/O modules are the senses of the automation system and can be easily connected to switches, indicator lamps, sensors, and other devices.

### Analog module

Analog modules can be connected to devices that process varying voltages and current signals.

## Easy system startup

- The IP address for each module can be set easily using the switches on the front of the module
- Additional functions can be set using switches as well, without requiring the engineering software GX Works3

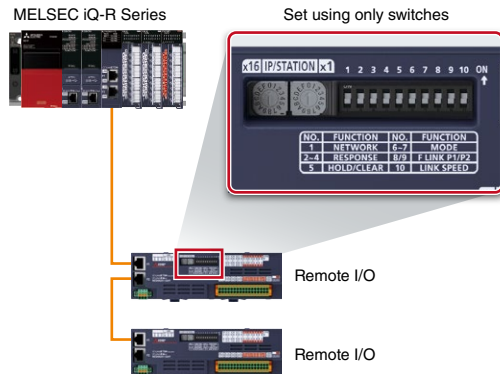

## Switch to CC-Link IE Field Network device station mode

- Setting the switches on the front of the module enables to be used as either a CC-Link IE TSN or CC-Link IE Field Network device station
- The module can be shared when using CC-Link IE TSN and CC-Link IE Field Network, reducing hardware costs

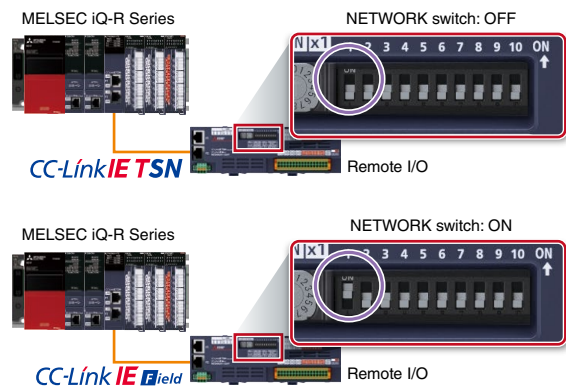

## CC-Link IE TSN-compatible block-type remote module specifications

### Input module

Model	Input type DC input	Input points	Rated input voltage/current	Wiring type	External interface
NZ2GN2S1-16D	Positive common Negative common	16 points	24 V DC (6.6 mA)	1-wire	Spring-clamp terminal block
NZ2GN2S1-32D	Positive common Negative common	32 points	24 V DC (6 mA)	1-wire	Spring-clamp terminal block
NZ2GN2B1-16D	Positive common Negative common	16 points	24 V DC (6.6 mA)	1-wire	Screw terminal block
NZ2GN2B1-32D	Positive common Negative common	32 points	24 V DC (6 mA)	1-wire	Screw terminal block
NZ2GNCE3-32D	Positive common	32 points	24 V DC (6.6 mA)	3-wire	Sensor connector (e-CON)
NZ2GNCF1-32D	Positive common Negative common	32 points	24 V DC (6.6 mA)	1-wire	40-pin connector

### Output module

Model	Output type Transistor output	Output points	Rated load voltage/Max. load current	Wiring type	External interface
NZ2GN2S1-16T	Sink	16 points	12/24 V DC (0.5 A/point, 4 A/common)	1-wire	Spring-clamp terminal block
NZ2GN2S1-16TE	Source	16 points	12/24 V DC (0.5 A/point, 4 A/common)	1-wire	Spring-clamp terminal block
NZ2GN2S1-32T	Sink	32 points	12/24 V DC (0.5 A/point, 5 A/common)	1-wire	Spring-clamp terminal block
NZ2GN2S1-32TE	Source	32 points	12/24 V DC (0.5 A/point, 5 A/common)	1-wire	Spring-clamp terminal block
NZ2GN2B1-16T	Sink	16 points	12/24 V DC (0.5 A/point, 4 A/common)	1-wire	Screw terminal block
NZ2GN2B1-16TE	Source	16 points	12/24 V DC (0.5 A/point, 4 A/common)	1-wire	Screw terminal block
NZ2GN2B1-32T	Sink	32 points	12/24 V DC (0.5 A/point, 5 A/common)	1-wire	Screw terminal block
NZ2GN2B1-32TE	Source	32 points	12/24 V DC (0.5 A/point, 5 A/common)	1-wire	Screw terminal block
NZ2GNCF1-32T	Sink	32 points	12/24 V DC (0.1 A/point, 3.2 A/common)	1-wire	40-pin connector

### I/O combined module

Model	Input type DC input	Input points	Rated input voltage/current	Output type Transistor output	Output points	Rated load voltage/Max. load current	Wiring type	External interface
NZ2GN2S1-32DT	Positive common	16 points	24 V DC (6 mA)	Sink	16 points	24 V DC (0.5 A/point, 4 A/common)	1-wire	Spring-clamp terminal block
NZ2GN2S1-32DTE	Negative common	16 points	24 V DC (6 mA)	Source	16 points	24 V DC (0.5 A/point, 4 A/common)	1-wire	Spring-clamp terminal block
NZ2GN2B1-32DT	Positive common	16 points	24 V DC (6 mA)	Sink	16 points	24 V DC (0.5 A/point, 4 A/common)	1-wire	Screw terminal block
NZ2GN2B1-32DTE	Negative common	16 points	24 V DC (6 mA)	Source	16 points	24 V DC (0.5 A/point, 4 A/common)	1-wire	Screw terminal block
NZ2GNCE3-32DT	Positive common	16 points	24 V DC (6.6 mA)	Sink	16 points	24 V DC (0.5 A/point, 4 A/common)	3-wire	Sensor connector (e-CON)

### Analog input module

Model	Input type	Number of channels	External interface
NZ2GN2S-60AD4	Analog voltage/current input	4 channels	Spring-clamp terminal block
NZ2GN2B-60AD4	Analog voltage/current input	4 channels	Screw terminal block

### Analog output module

Model	Output type	Number of channels	External interface
NZ2GN2S-60DA4	Analog voltage/current output	4 channels	Spring-clamp terminal block
NZ2GN2B-60DA4	Analog voltage/current output	4 channels	Screw terminal block

CPU

I/O

Analog/  
temperature input/  
temperature controlMotion/  
positioningHigh-speed counter/  
isolated pulse/  
flexible high-speed I/O

FPGA

Network

Advanced  
informationEnergy  
measuring

Software

**Waterproof/dustproof type (IP67) remote module**

- The control panel is not needed due to the IP67 rating, reducing costs and saving space

Model	Input type DC input	Input points	Rated input voltage/current	Output type Transistor output	Output points	Rated load voltage/Max. load current	Wiring type	External interface
<b>Input module</b>								
NZ2GN12A4-16D	Positive common	16 points	24 V DC (7.3 mA)	-	-	-	2- to 4-wire	Waterproof connector (screw lock)
NZ2GN12A4-16DE	Negative common	16 points	24 V DC (7.3 mA)	-	-	-	2- to 4-wire	Waterproof connector (screw lock)
<b>Output module</b>								
NZ2GN12A2-16T	-	-	-	Sink	16 points	12/24 V DC (2 A/point, 4 A/point, 12 A/common)*1	2-wire	Waterproof connector (screw lock)
NZ2GN12A2-16TE	-	-	-	Source	16 points	12/24 V DC (2 A/point, 4 A/point, 12 A/common)*1	2-wire	Waterproof connector (screw lock)
<b>I/O combined module</b>								
NZ2GN12A42-16DT	Positive common	8 points	24 V DC (7.3 mA)	Sink	8 points	12/24 V DC (2 A/point, 4 A/point, 12 A/common)*1	2- to 4-wire (input) 2-wire (output)	Waterproof connector (screw lock)
NZ2GN12A42-16DTE	Negative common	8 points	24 V DC (7.3 mA)	Source	8 points	12/24 V DC (2 A/point, 4 A/point, 12 A/common)*1	2- to 4-wire (input) 2-wire (output)	Waterproof connector (screw lock)

\*1. Maximum load current specifications may vary depending on the type of output terminal. For details, please refer to the "CC-Link IE TSN Remote I/O Module User's Manual (CC-Link IE TSN Communication Mode) (SH-082135ENG)."

**Block-type remote module with safety functions**

- Block-type remote modules that support safety functions
- Performs safety control when used together with the MELSEC iQ-R Series safety CPU module
- Single or double wiring can be selected per input and output point
- Compliant with international safety standards, ISO 13849-1 Category 4 PL e and IEC 61508 SIL 3 (NZ2GNS12A2-14DT complies with Category 3)
- The waterproof/dustproof type (IP67) I/O combined module can be set to operate as a device station for the CC-Link IE Field Network using the front switch\*2 **NEW**

Model	Input type DC input	Input points	Rated input voltage/current	Output type Transistor output	Output points	Rated load voltage/Max. load current	Wiring type	External interface
<b>Input module</b>								
NZ2GNSS2-8D	Negative common	Single wiring: 8 points Double wiring: 4 points	24 V DC (7.3 mA)	-	-	-	2-wire	Spring-clamp terminal block
<b>Output module</b>								
NZ2GNSS2-8TE	-	-	-	Source + source	Single wiring: 8 points Double wiring: 4 points	24 V DC (0.5 A/point, 4 A/common)	2-wire	Spring-clamp terminal block
<b>I/O combined module</b>								
NZ2GNSS2-16DTE	Negative common	Single wiring: 8 points Double wiring: 4 points	24 V DC (7.3 mA)	Source + source	Single wiring: 8 points Double wiring: 4 points	24 V DC (0.5 A/point, 4 A/common)	2-wire	Spring-clamp terminal block
<b>Waterproof/dustproof type (IP67) I/O combined module</b>								
NZ2GNS12A2-14DT	Negative common	Single wiring: 12 points Double wiring: 6 points	24 V DC (6.8 mA)	Source + sink	Single wiring: not possible Double wiring: 2 points	24 V DC (2 A/point, 4 A/point, 6 A/common) *3	2-wire	Waterproof connector (screw lock)
NZ2GNS12A2-16DTE	Negative common	Single wiring: 12 points Double wiring: 6 points	24 V DC (6.8 mA)	Source + source	Single wiring: 4 points Double wiring: 2 points	24 V DC (2 A/point, 4 A/point, 8 A/common) *4	2-wire	Waterproof connector (screw lock)

\*2. When using safety communication for the CC-Link IE Field Network, check the following URL.

[www.MitsubishiElectric.com/fa/products/cnt/plcnet/pmerit/cclink\\_ie/lineup/safety\\_io.html](http://www.MitsubishiElectric.com/fa/products/cnt/plcnet/pmerit/cclink_ie/lineup/safety_io.html)

\*3. Maximum load current specifications may vary depending on the type of output terminal. For details, please refer to the "CC-Link IE TSN Waterproof/Dustproof Remote I/O Module (With Safety Functions) User's Manual (SH-082508ENG)."

\*4. Maximum load current specifications may vary depending on the type of output terminal. For details, please refer to the "CC-Link IE TSN Waterproof/Dustproof Remote I/O Module (With Safety Functions) User's Manual (SH-082466ENG)."

CC-Link IE Field Network-compatible remote modules (including remote I/O-Link module) and CC-Link-compatible remote modules are also available. For details, please refer to the catalogs below.

"Ethernet-based Open Network CC-Link IE Product Catalog (L(NA)08111E)"  
 "Open Field Network CC-Link Compatible Product Catalog (L(NA)08038E)"



## CC-Link IE TSN-compatible bridge module

The CC-Link IE TSN-compatible bridge module seamlessly connects CC-Link IE TSN-compatible networks on one network.



## CC-Link IE TSN-CC-Link IE Field Network bridge module

### N2ZGN-GFB

- Seamlessly integrates CC-Link IE Field Network into CC-Link IE TSN
- Can be used as a remote station on CC-Link IE TSN and either as a master or local station on CC-Link IE Field Network
- Enables CC-Link IE TSN devices to be added to the existing equipment, or CC-Link IE Field devices to be added to CC-Link IE TSN

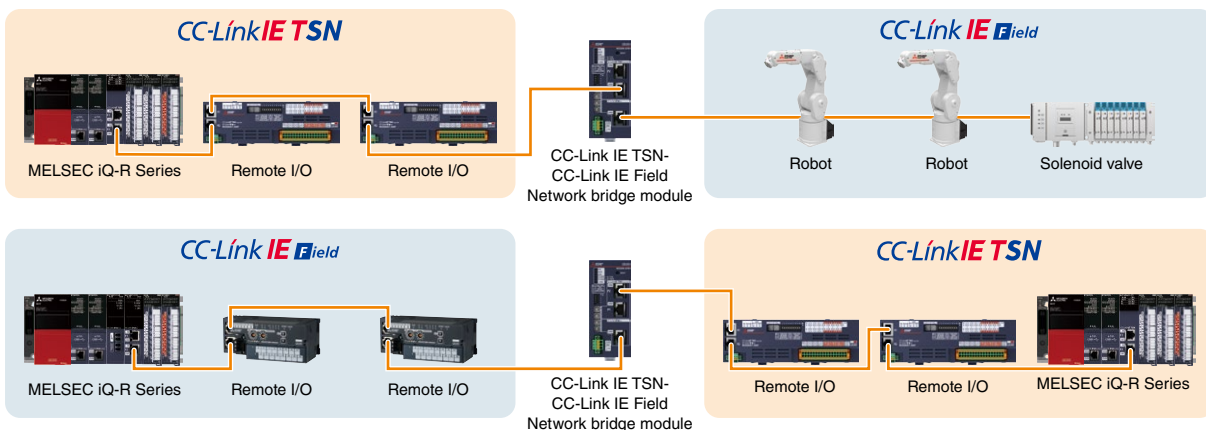

## CC-Link IE TSN-AnyWireASLINK bridge module\*1

### N2ZAW1GNAL

- Seamlessly integrates AnyWireASLINK products via CC-Link IE TSN
- AnyWireASLINK is a reduced-wiring network which realizes monitoring of sensors with less space required for wiring
- Supports iQSS (iQ Sensor Solution) which enables parameter setup and monitoring of AnyWireASLINK products



\*1. For further details, please refer to "Digital link sensor AnyWireASLINK catalog (L (NA) 08221E)."

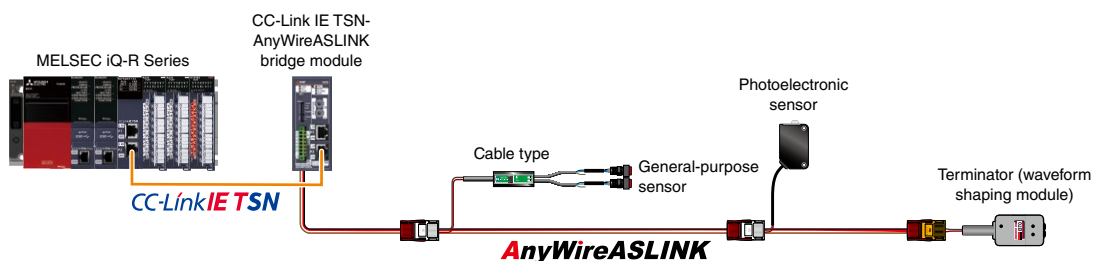

CPU
I/O
Analog/temperature input/temperature control
Motion/positioning
High-speed counter/ isolated pulse/ flexible high-speed I/O
FFGA
Network
Advanced information
Energy measuring
Software

# Advanced information module

A cycle of collecting and analyzing production data for improvement is necessary to achieve “operating ratio improvement by preventive maintenance,” “high-speed equipment and production lines,” “traceability,” and “energy saving. Advanced information modules enable data communication with the IT system and programmable controllers, realizing coordination between the IT system and the shop floor.

## Simplify error analysis through extensive recording of equipment data

### Recorder module RD81RC96/Camera recorder module RD81RC96-CA



RD81RC96 RD81RC96-CA

- Record with a time-stamp per controller scan
- All device/label/event history recording
- Easy setting of recording targets
- Extensive recording of camera images\*1

\*1. Supported by the camera recorder module only.

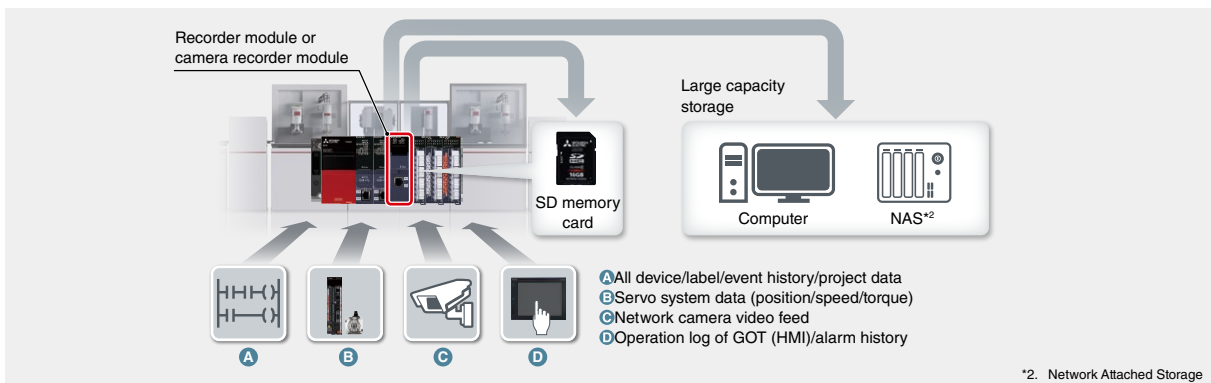

\*2. Network Attached Storage

►For details, see page 132.

## Easily connect the programmable controller and database

### MES interface module RD81MES96N



- Easily set without a program
- Direct access to database

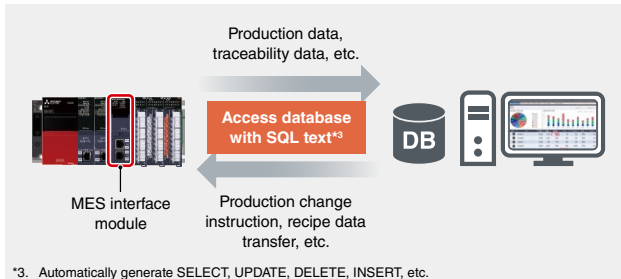

\*3. Automatically generate SELECT, UPDATE, DELETE, INSERT, etc.

►For details, see page 133.

Connect data using a secure and open communication protocol

■ OPC UA server module RD810PC96



- Robust security
- Standardization of shop floor data

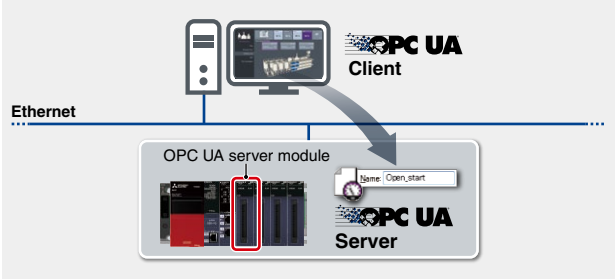

► For details, see page 134.

Sample data to utilize for traceability and maintenance

■ High-speed data logger module RD81DL96



- High-speed data sampling with easy setting
- Directly port to Excel®

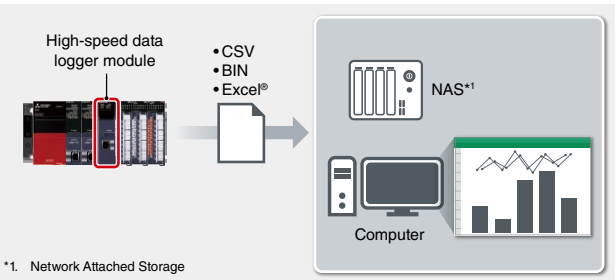

■ High-speed data communication module RD81DC96



- High-speed streaming transfer in real-time
- Support highly flexible programming

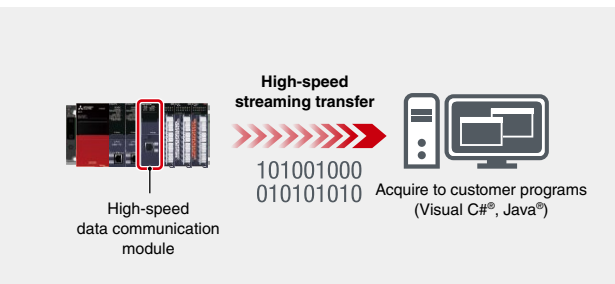

► For details, see page 135.

Data destination/data type/applications of each module

Product name	Recorder	Camera recorder	MES interface	OPC UA server	High-speed data logger	High-speed data communication
Data destination	Computer/ NAS (file server) SD memory card	Computer/ NAS (file server) SD memory card	Widely available/open source database	Computer (OPC UA client)	Computer/ NAS (file server) SD memory card	Computer (user program)
Data type	All device/label/ event history/ project data	All device/label/ event history video data/ project data	Preset device data	Preset device data	Preset device data	Preset device data
Applications	<ul style="list-style-type: none"> <li>Corrective maintenance</li> <li>Debug/startup</li> </ul>	<ul style="list-style-type: none"> <li>Corrective maintenance</li> <li>Debug/startup</li> </ul>	<ul style="list-style-type: none"> <li>Traceability</li> <li>Production instruction</li> <li>Production results management</li> </ul>	<ul style="list-style-type: none"> <li>Equipment operation monitoring</li> <li>Production progress management</li> </ul>	<ul style="list-style-type: none"> <li>Traceability</li> <li>Corrective maintenance</li> <li>Production results management</li> </ul>	<ul style="list-style-type: none"> <li>Production data monitoring</li> <li>Preventive maintenance</li> </ul>

- CPU
- I/O
- Analog/temperature input/temperature control
- Motion/positioning
- High-speed counter/isolated pulse/flexible high-speed I/O
- FPGA
- Network
- Advanced Information
- Energy measuring
- Software

# Recorder module

## Camera recorder module

**RD81RC96**

**RD81RC96-CA**



The recorder and camera recorder modules are dedicated recording (logging) modules for system recording.

The modules can collect all device, label data, and event history per programmable controller scan prior to and after an error event together with a time-stamp.

### Quickly identify error cause when an error occurs

Support error cause identification      Minimal impact on downtime

- The modules enable extensive recording of information such as device data of the programmable controller and network camera images which is necessary for quickly identifying the root-cause of an error
- Recorded data can be analyzed in synchronization with the related programs, allowing easy identification of error causes by checking the relation between cause and effect
- By promptly investigating the actual cause, debugging time at equipment startup can be reduced and loss during system downtime can be minimized

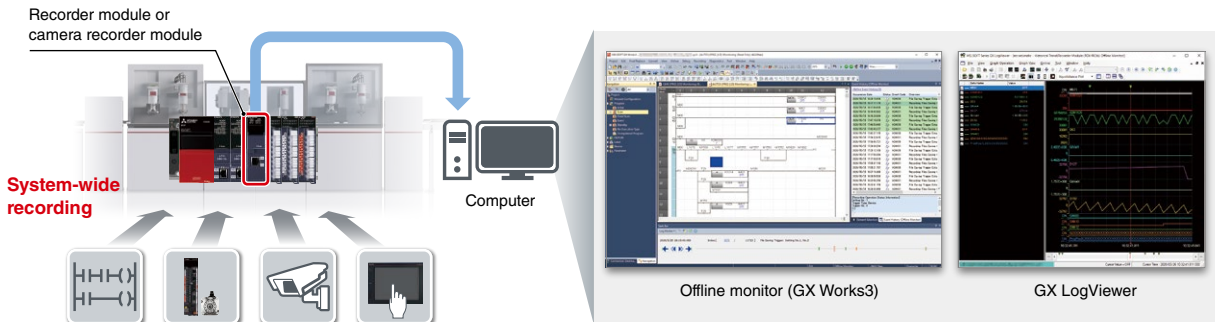

### Minimal impact on the scan time by filtering of devices and labels

Minimal impact on the scan time

- Collect all device/label data prior to and after an error with a time-stamp
- If target devices/labels are decided, influence on the CPU scan time is minimized by filtering of devices and labels

Specifying the collection target	
Device/label	
Sampling target	
Label data type	
Range	
Program file name	
Data name	
Comment	

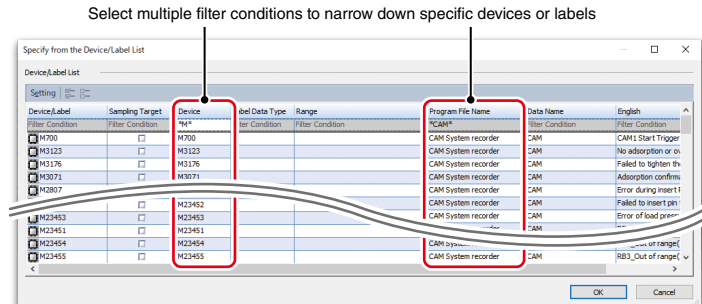

### Recording target data of each module

Product name	Recording targets
Recorder module	All device logging data
Camera recorder module	All device logging data + video data

For details on corrective maintenance solution system recorder using the recorder module or camera recorder module, please refer to page 34.

## MES interface module

Database is a mandatory requirement with today's manufacturing needs. The MES interface module enables direct connectivity between the IT system database and the controller system, allowing production instruction and data collection.



RD81MES96N

### Easy data utilization from database

Easy data utilization

Easy data sharing

- Data in the MES interface module can be stored in the database
- Data in the database can be easily visualized by the extensive compatibility with SCADA software GENESIS64™ and such, data analysis can be utilized for quality control
- Data in the database can be shared with the office as well as the production site, allowing people in different positions to check at the same time

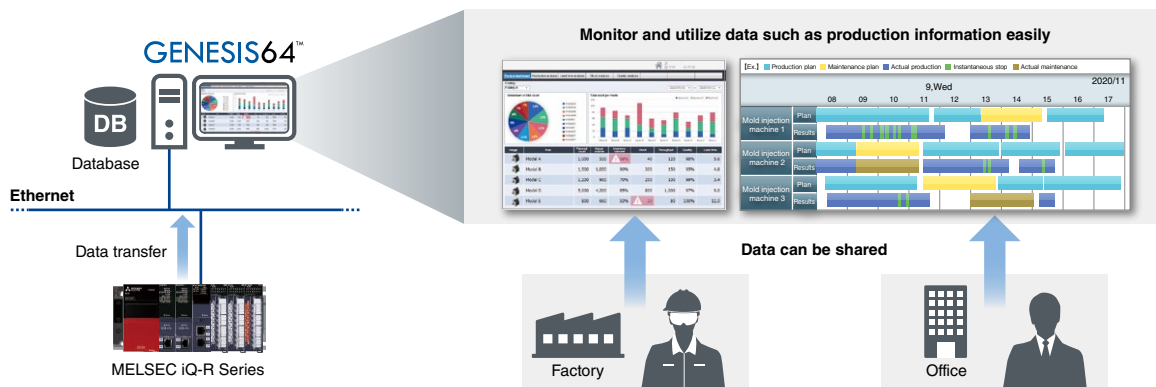

### Easy system configuration without a dedicated program

Direct access to database

Maintenance cost reduction

- The module enables direct connectivity between IT database servers and programmable controllers, eliminating the need for gateway computers or dedicated programs and simplifying the system configuration
- The MES interface module accesses the database server as a client, eliminating unnecessary polling and reducing the load to the network, programmable controller, and IT system
- Less hardware maintenance is required, reducing overall system cost as the module is robust even in the harsh industrial environments compared to computers

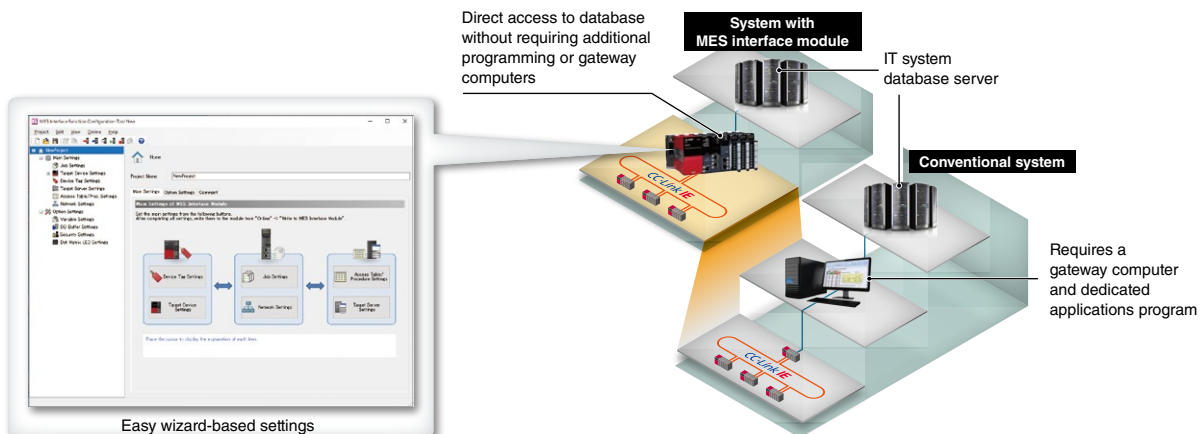

- CPU
- I/O
- Analog/temperature input/temperature control
- Motor/positioning
- High-speed counter/ isolated pulse/ flexible high-speed I/O
- FPGA
- Network
- Advanced Information
- Energy measuring
- Software

## OPC UA server module

The OPC UA server module realizes embedded OPC UA server which can be installed directly on the MELSEC iQ-R Series base unit. Using this module integrates the OPC UA server directly into the equipment.



RD810PC96



### OPC UA: Essential to stay ahead with data utilization

Today's manufacturing requires flexible, fast data utilization.

The key is to add value to data by seamlessly connecting shop floor and IT systems.

► **OPC UA, anticipated as the standard for supporting digital transformation in manufacturing, is essential for success in data utilization**



Open Platform Communications  
Unified Architecture

**International data exchange standard for safe, reliable, manufacturer- and platform-independent industrial communication**

### Integrate the strengths of OPC UA into programmable controller systems

Resolve your concerns about data utilization with the three key strengths of OPC UA!



Concern

01

Adapting to communication protocols for devices from various manufacturers and systems, both old and new, is **time-consuming and costly**



Connect

**Unified communication protocol between systems**

- OPC UA enables communication with a unified protocol between devices and IT systems, thereby creating an open, manufacturer-independent network

**Connect devices and IT systems with minimal effort and cost**



Concern

02

With large amounts of critical data being exchanged more frequently, **how can we prevent data leakage?**



Secure

**Connection destination authentication, communication encryption**

- OPC UA ensures highly reliable communication with its robust security features, including certificates, encryption, and signatures

**Protect data from theft and tampering**



Concern

03

The need for updates on the link application each time new equipment is added **complicates data sharing and system coordination**



Communicate

**Communicating the meaning and relationships of data**

- OPC UA enhances system interoperability by standardizing data structures and interfaces using information models
- Various information models provided by industry organizations and vendors are planned to be supported

**Ensure smooth data sharing and coordination between systems**

## High-speed data logger module

## High-speed data communication module

RD81DL96

RD81DC96



The modules enable high-speed data sampling in synchronization with the programmable controller scan time and send data to the general software or customer programs.

### Utilize sampled data on general software

RD81DL96

Directly port to Excel®/CSV

Record in the SD memory card

- A single module can output Excel® data. Data can be accumulated on Excel® and visualized in an easy to understand format such as a graph
- Logging data can be saved in the SD memory card and transferred to the file server
- Recommended for the following customers
  - Utilize general software (Excel®, CSV, etc.)
  - Easily analyze the output data

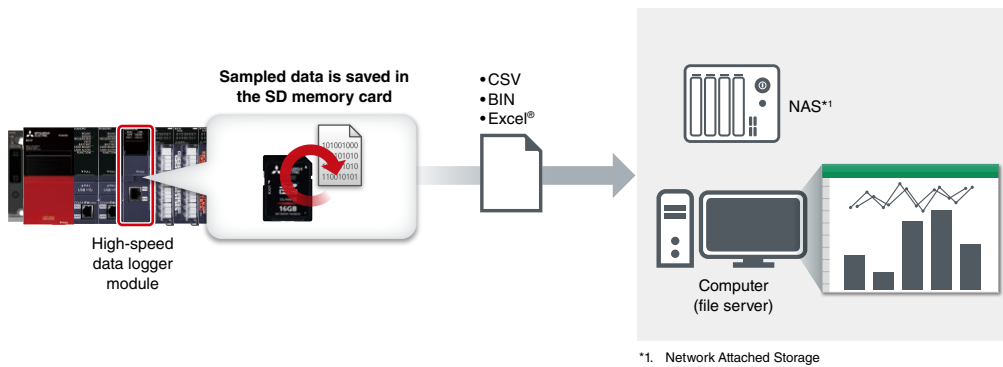

### Utilize data in coordination with customer programs

RD81DC96

High-speed streaming

Easy programming

- Production data streamed at high speed can be transferred to customer programs
- Since successive data acquisition into programs is possible, it is useful for frequent data sampling
- Utilizing available Visual C#® and Java® class libraries reduces programming time
- Recommended for the following customers
  - Transfer a large-capacity data to the IT system in real-time
  - Apply sampled data to various applications

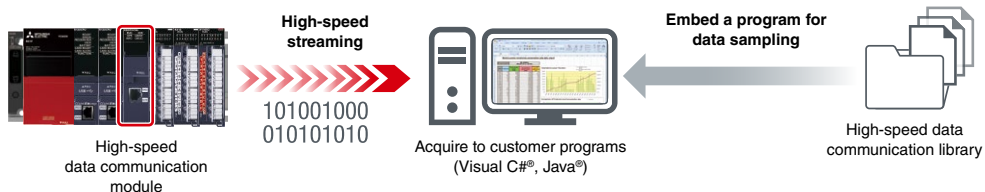

CPU

I/O

Analog/temperature input/temperature control

Motion/positioning

High-speed counter/isolated pulse/flexible high-speed I/O

PLC

Network

Advanced Information

Energy measuring

Software

**Recorder module, camera recorder module specifications**

Item	RD81RC96	RD81RC96-CA
Recording target	Device/label, event history	Device/label, event history, video data
Number of recording settings	Up to 4	
Recording method	File saving trigger only, recording startup trigger + file saving trigger	
File saving trigger	Device of the control CPU module, (rise, fall, timeout), elapsed time after completion of data accumulation, control CPU module stop error	Device of the control CPU module, (rise, fall, timeout), elapsed time after completion of data accumulation, control CPU module stop error, camera event
Recording startup trigger	Rise/fall (1 per recording setting)	
Sampling method	Each scan, time specification, trigger instruction, safety cycle time	
Number of connectable modules	One recorder module per control CPU	Four camera recorder modules per control CPU
Applicable cameras*1	Camera type	-
	Number of cameras	-
Save destination	SD memory card, file server	
Compatible CPU module	R04/08/16/32/120(EN)CPU, R08/16/32/120SFCPU*3	

\*1. For details of compatible camera, please refer to the technical bulletin (FA-A-0326).

\*2. Up to two units can be connected when recording operation setting is set to "Main" and up to four units when set to "Sub." For the number of connected network cameras and module configuration, please refer to the "MELSEC iQ-R System Recorder User's Manual (Application) (SH-082281ENG)."

\*3. Compatible CPU modules can be checked from product information. For details, please refer to the "MELSEC iQ-R System Recorder User's Manual (Startup) (SH-082279ENG)."

**MES interface module specifications**

Item	RD81MES96N
Database connection	
Supported database*4	Oracle® Database, Microsoft® SQL Server®, Microsoft® Access®, MySQL®, PostgreSQL®, MariaDB®
Database communication type	SELECT, INSERT, UPDATE, DELETE, Multi-SELECT, Multi-INSERT*5, STORED PROCEDURE*5
Number of field settings per project	Max. 65536 fields
Accessible CPU module*4	MELSEC iQ-R, MELSEC-Q, MELSEC-L, MELSEC iQ-F, MELSEC-F Series
Data sampling interval	
High-speed data sampling	1...9 ms, 1...9 x 10 ms, 1...9 x 100 ms, 1...60 s
General data sampling (s)	0.1...0.9, 1...3600

\*4. For details, please refer to the "MELSEC iQ-R MES Interface Module User's Manual (Startup) (SH-081422ENG)."

\*5. Supported when used with Oracle® Database, SQL Server®, MySQL®, PostgreSQL®, and MariaDB® database. For details, please refer to the "MELSEC iQ-R MES Interface Module User's Manual (Startup) (SH-081422ENG)."

**OPC UA server module software specifications**

Item	RD81OPC96
Profile	Embedded 2017 UA Server Profile, OPC Spec Version 1.04
Encryption setting (security policy)*6	<ul style="list-style-type: none"> <li>• None: No security</li> <li>• Aes256-Sha256-RsaPss: AES 256-bit encryption + SHA-256</li> <li>• Aes128-Sha256-RsaOaep: AES 128-bit encryption + SHA-256</li> <li>• Basic256Sha256: Basic 256-bit encryption + SHA-256</li> <li>• Basic256 (deprecated): Basic 256-bit encryption</li> <li>• Basic128Rsa15 (deprecated): Basic 128-bit encryption</li> </ul>
Signature setting (security mode)	<ul style="list-style-type: none"> <li>• None: No security</li> <li>• Sign: Add signature</li> <li>• Sign &amp; Encrypt: Add signature and encryption</li> </ul>
User authentication setting	<ul style="list-style-type: none"> <li>• Anonymous</li> <li>• User name/password</li> <li>• Certificate validation</li> </ul>
Connected OPC UA clients	
Max. number of sessions	15
Connectable Ethernet port	CH1
Information models and mapping specifications*7	
Namespace	Number of Namespaces
	10
Node	Number of Nodes
	Number of mappable Variables (total)
	50000
	25000

\*6. Available security policies differ for each firmware version of the OPC UA server module and software version of the configuration tool. For details, please refer to the "MELSEC iQ-R OPC UA Server Module User's Manual (Application) (SH-081694ENG)."

\*7. Either tag mode or information model mode can be selected depending on the use. This specification refers to the information model mode.

For details on the tag mode, please refer to "MELSEC iQ-R OPC UA Server Module User's Manual (Startup) (SH-081693ENG)."

For details on the information model mode, please refer to "MELSEC iQ-R OPC UA Server Module User's Manual (Information Model) (SH-082679ENG)."

**High-speed data logger module, high-speed data communication module specifications**

Item	RD81DL96	RD81DC96
Accessible CPU module	MELSEC iQ-R Series (direct, remote), Q Series (remote), L Series (remote)	
Data sampling interval		
High-speed data sampling (ms)	<ul style="list-style-type: none"> <li>• Programmable controller scan time synchronization</li> <li>• 0.5...0.9, 1...32,767 (for trigger logging)</li> <li>• 2...32,767 (for continuous logging)</li> </ul>	<ul style="list-style-type: none"> <li>• Programmable controller scan time synchronization</li> <li>• 0.5...0.9, 1...32,767</li> </ul>
General data sampling (s)	<ul style="list-style-type: none"> <li>• 0.1...0.9, 1...32,767</li> <li>• Time interval specification (specify hour/minute/second)</li> </ul>	<ul style="list-style-type: none"> <li>• 0.1...0.9, 1...32,767</li> </ul>
Amount of sampled data		
High-speed data sampling	<ul style="list-style-type: none"> <li>• Overall amount of data: 32,768 (per setting: 1,024)</li> <li>• Overall number of device points: 32,768 (per setting: 4,096)</li> </ul>	<ul style="list-style-type: none"> <li>• Overall amount of data: 32,768</li> </ul>
General data sampling	<ul style="list-style-type: none"> <li>• Overall amount of data: 65,536 (per setting: 1,024)</li> <li>• Overall number of device points: 262,144 (per setting: 4,096)</li> </ul>	<ul style="list-style-type: none"> <li>• Overall number of device points: 262,144 (per connection: 65,536)</li> </ul>



# Energy measuring module

The energy measuring module can process measured data at a refresh cycle of 10 ms and is ideal for energy saving and predictive maintenance at the manufacturing site.



RE81WH

## Highly detailed energy measurements by simple setting and installation

Easy installation and setting

Highly detailed measuring

- By directly installing the module on a vacant slot of the base unit, measurement functions can be added without changing the layout in the control panel
- Setup is easily done with the engineering software GX Works3 without having to develop a program
- Highly detailed energy measuring at a refresh cycle of 10 ms, which is ideal for manufacturing equipment for beverage and semiconductor industries

Existing product (QE81WH)

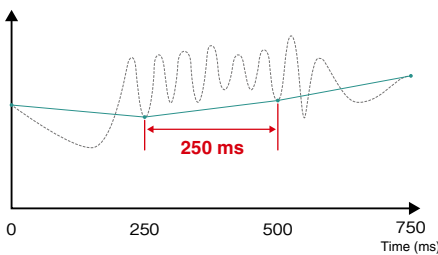

RE81WH

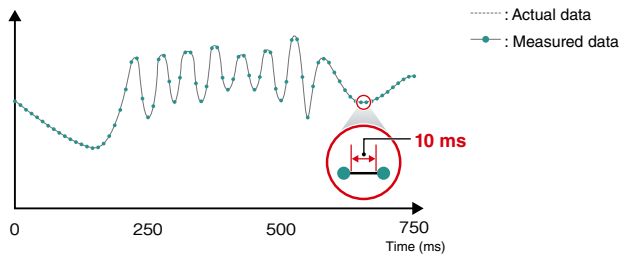

## Visualize CO<sub>2</sub> emissions and other data in coordination with e-F@ctory starter package

CO<sub>2</sub> emissions management

Visualization

- CO<sub>2</sub> emissions, specific energy consumption, production volume, and electric energy can be easily checked with free sample projects of programmable controller and GOT (HMI)
- CO<sub>2</sub> emissions are displayed on the GOT (HMI) allowing real-time monitoring on the shop floor. This will help raise awareness of CO<sub>2</sub> emission reduction in manufacturing
- Electric energy and production volume data are saved for energy loss analysis per production line and equipment process

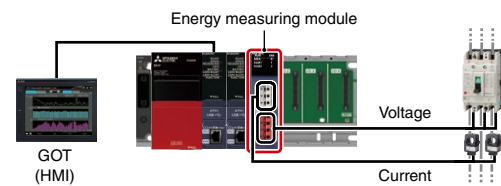

### Energy measuring module specifications

Item	RE81WH
Number of measurable circuits	1
Phase-wire systems	Single-phase 2-wire, single-phase 1-wire, three-phase 3-wire common
Current circuit (A AC)	5, 50, 100, 250, 400, 600*1 5*2
Voltage circuit	
Single-phase 2-wire, three-phase 3-wire (V AC)	110, 220 common*3
Single-phase 3-wire (V AC)	110 (1-2 lines, 2-3 lines), 220 (1-3 lines)
Measurement specifications	
Data refreshing cycle (ms)	10...10000*4
Measurement items	Current, current demand, voltage, electric power, electric power demand, reactive power, apparent power, harmonic current, harmonic voltage, frequency, power factor, electric energy, reactive energy

\*1. A value when a dedicated split-type current sensor is used. Each value indicates current sensor's primary current value.

\*2. A value when a dedicated 5 A current sensor is used. A 5 A current sensor is used with two-stage configuration in combination with a current transformer (CT). Primary current value can be set up to 6000 A.

\*3. Up to 6600 V can be set in combination with a voltage transformer (VT).

\*4. Can be set in increments of 10 ms.

CPU

I/O

Analog/temperature input/temperature control

Motion/positioning

High-speed counter/isolated pulse/flexible high-speed I/O

FFGA

Network

Advanced Information

Energy measuring

Software

## FA integrated engineering software

# MELSOFT iQ Works

MELSOFT iQ Works is an integrated software suite consisting of GX Works3, MT Works2, GT Works3, RT ToolBox3, FR Configurator2, CW Configurator, and MR Configurator2, which are programming software for each respective product. Integration is further enhanced with MELSOFT Navigator as the central system configuration. The advantages of this powerful integrated software suite are that system design is made much easier with a substantial reduction in repetitious tasks, cutting down on errors while helping to reduce the overall TCO.

### System management software

## MELSOFT Navigator

System level graphic-based configuration tool that simplifies the system design by providing a visual representation of the system. System management features such as system-wide parameterization, labels and block reading of project data are also included.

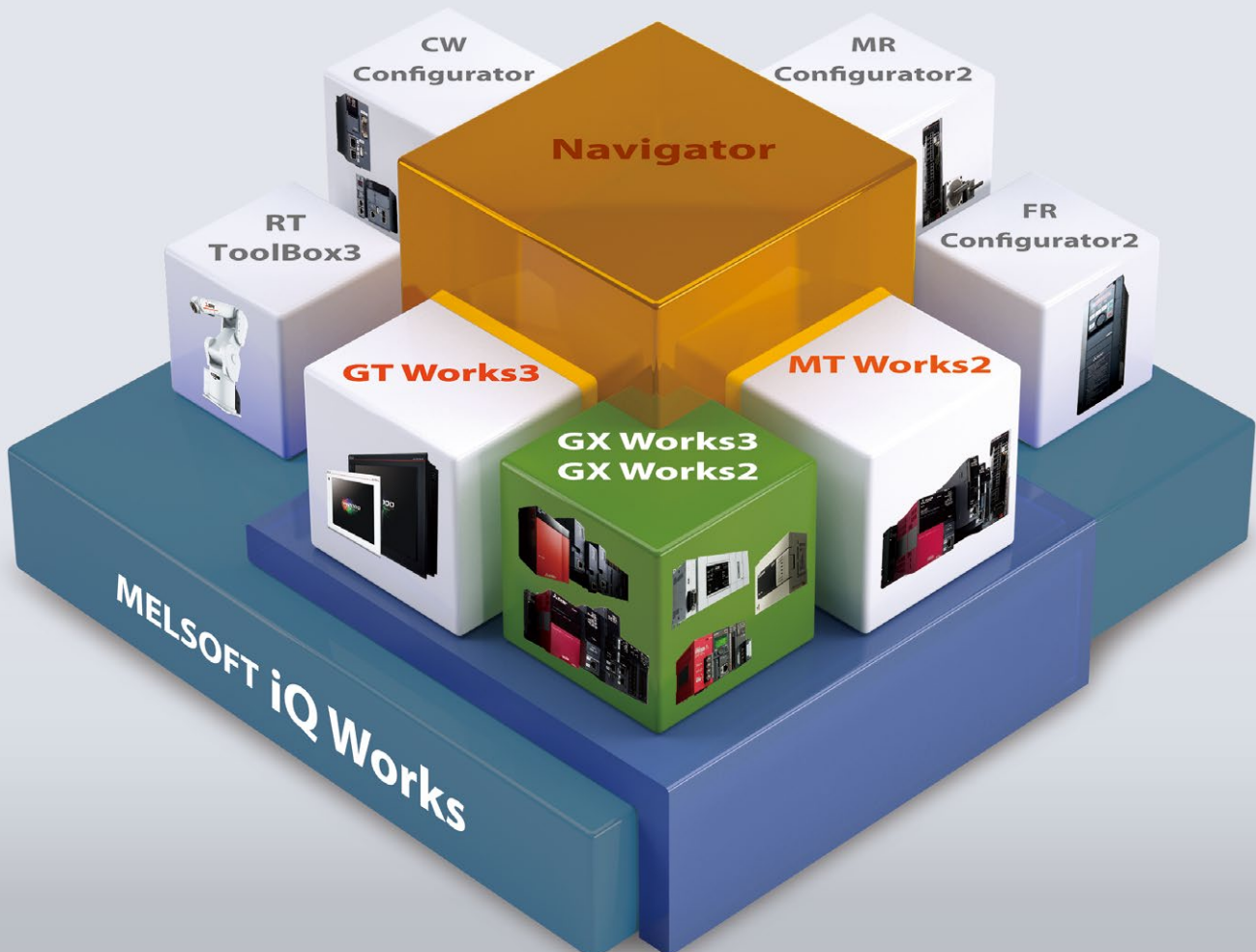
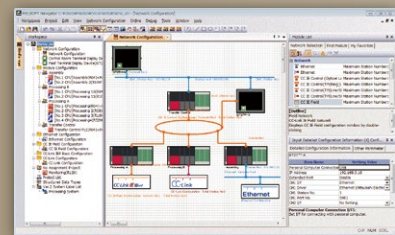

**Programmable controller engineering software**

Programming and maintenance software specifically designed for the MELSEC iQ-R Series control system.

**MELSOFT GX Works3**

It includes many features such as graphic-based configuration, simple point and click programming architecture, and diagnostics function enabling easy troubleshooting, reducing engineering cost.

**MELSOFT GX Works2**

Incorporating backward compatibility of programs created with GX Developer, GX Works2 further improves its functionality resulting in reduced engineering costs.

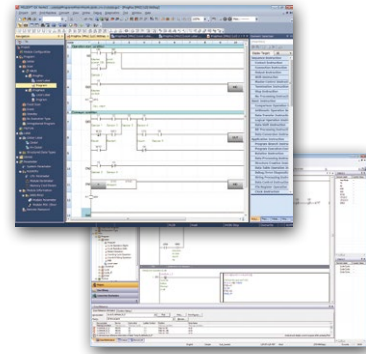

**GOT (HMI) screen design software**

**MELSOFT GT Works3**

This graphic operation terminal (GOT) screen creation software is designed with three main features—simplicity, graphics design and operation ease—that help to create graphic screens in fewer steps.



**Motion controller engineering software**

**MELSOFT MT Works2**

This motion control design and maintenance software includes intuitive graphic-based programming together with a digital oscilloscope simulator, helping to reduce the motion system TCO.



**Robot engineering software**

**MELSOFT RT ToolBox3\*1**

This robot engineering software supports various steps from programming, to commissioning, evaluation, and maintenance. In addition, improved preventative maintenance is realized through the use of an integrated 3D robot simulator.

\*1. RT ToolBox3 mini (simplified version) will be installed if iQ Works product ID is used.  
When RT ToolBox3 (with simulation function) is required, please purchase RT ToolBox3 product ID.

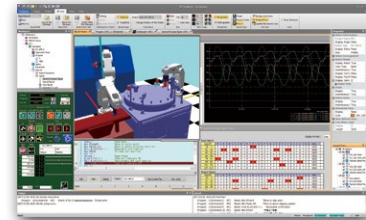

**Inverter setup software**

**MELSOFT FR Configurator2**

This software simplifies settings from the setup to maintenance of inverters. Parameters can be registered easily and distributed to multiple inverters when replacing, and activation of the PLC function all from one setup screen.

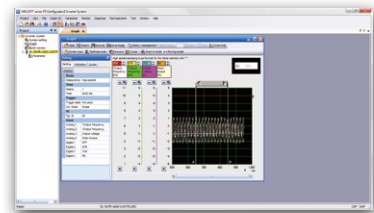

**C Controller setting and monitoring tool**

**MELSOFT CW Configurator**

This C Controller parameter setting and monitoring software simplifies parameter setting, diagnostics, monitoring and testing. Using CW Configurator is as easy as using the engineering software GX Works3, which shares similar interfaces.

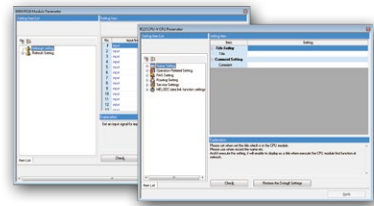

**Servo setup software**

**MELSOFT MR Configurator2**

This servo setup software used for easy monitoring, diagnostics, registering parameters, and testing of the servo amplifier.

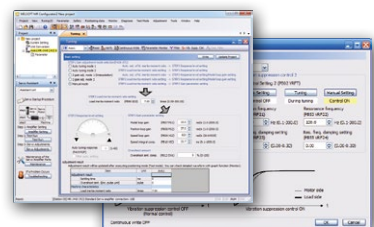

CPU

I/O

Analog/  
temperature input/  
temperature control

Motion/  
positioning

High-speed counter/  
isolated pulse/  
flexible high-speed I/O

FFGA

Network

Advanced  
Information

Energy  
measuring

Software

## Intuitive engineering software

# GX Works3

### ■ Graphic-based configuration realizing easier programming

Various intuitive features such as graphic-based system configuration and an extensive module library (module label/FB\*1) provided as standard.

### ■ Integrated motion-control system configuration

From setting simple motion module parameters and positioning data setup to servo amplifier configuration, everything is packaged into an easy-to-use engineering environment.

### ■ Complies with IEC 61131-3

GX Works3 realizes structured programming such as ladder and ST, making project standardization across multiple users even easier.

\*1. FB: Function Block

## Simple point and click programming architecture

### Straightforward graphic based system configuration design

- Simply drag and drop from the module list to easily create system configuration
- Directly setup parameters for each module
- Automatically reflect changes in the layout to the module

### MELSOFT Library enables efficient programming through “module label/FB”

- Assign convenient label names to internal devices, rather than manually entering a device name every time
- Simply drag & drop module FBs from the MELSOFT Library directly into the ladder program, making programming even easier

### Extensive version control features

- Flexibly register program change (historical) save points
- Easily visualize and confirm program changes

---

### Simple motion setting tool

Easily configure the simple motion module with this convenient integrated tool.

---

### Tab view multiple editors

Conveniently work on multiple editors without having to switch between software screens.

---

### Navigation window

Easily access project components. Organize program file list.

---

### Module configuration

Easily parameterize each module directly from the configuration editor.

---

### Module list

Simply drag & drop modules directly into the module configuration.



Mitsubishi Electric  
MELSOFT GX Works3  
"Promotion" Movie

## One Software, Many Possibilities

Reduce engineering time by 60%\*1

### Global realization by multi-language support

To adhere to today's global production needs, GX Works3 supports multi-language features at various levels, from the multiple language software menu system to device comment language switching features.

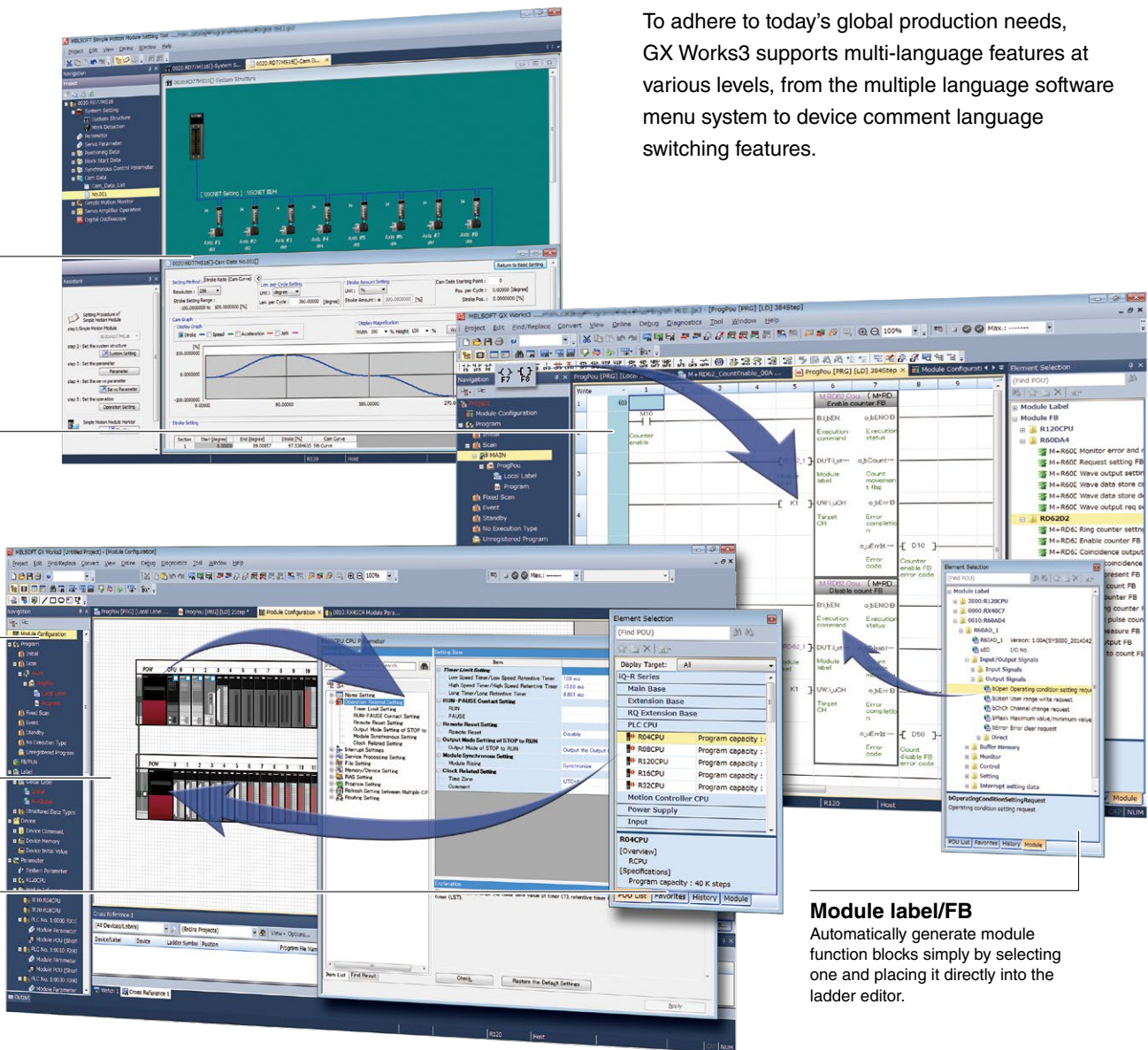

**Module label/FB**  
Automatically generate module function blocks simply by selecting one and placing it directly into the ladder editor.

\*1. Based on new project test benchmarks between GX Works2 and GX Works3.

- CPU
- I/O
- Analog/temperature input/temperature control
- Motion/positioning
- High-speed counter/isolated pulse/temperature control
- FFGA
- Network
- Advanced information
- Energy measuring
- Software

## Data access software

### MELSOFT MX Component

MELSOFT MX Component is the ActiveX® control/.NET control library enabling communication from a computer to a programmable controller and motion controller regardless of communication protocol.

Complicated programs for serial and Ethernet communication can be developed with simple steps.

MELSOFT MX Component for iOS/Android™ which can easily develop applications for a mobile device is also available.

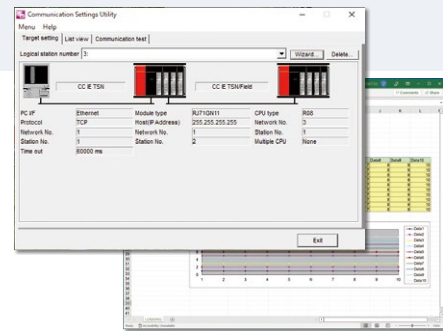

### MELSOFT MX Sheet

MELSOFT MX Sheet enables monitoring, logging, collecting alarm information, and changing setting values of the programmable controller or motion controller using familiar Excel®.\*1 MELSOFT MX Sheet operation conditions can be set from Excel® without requiring a communication program. Production, operation, and alarm information can be confirmed on Excel®, introducing IIoT technologies easily.

\*1. MX Component is required to use MX Sheet.

A bundle package (MX Works) including MX Sheet and MX Component is available

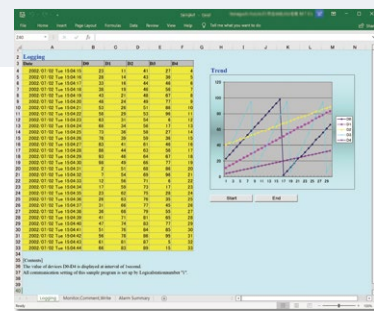

## Visualization software

### MELSOFT GX VideoViewer Pro

GX VideoViewer Pro automatically extracts differences in a video feed and easily identify an error cause.

Differences in the video feed from normal patterns generated during normal operation are extracted based on “appearance (color, shape, position, etc.)” and “operation (movement amount in unit time);” then log markers are automatically added.

The error cause can be easily identified in two steps; model generation and difference extraction.



### GENESIS64™

In addition to visualization of data collected by the MELSEC Series, GENESIS64™ manages large volumes of data and provides connectivity to upper-level IT systems such as MES (Manufacturing Execution System). This software enables factories to monitor and analyze data to drive operational excellence.



## Simulation software

### MELSOFT Gemini

MELSOFT Gemini digitally simulates machine operation and production line processes to enable accelerated design, validation, and optimization of new systems and modifications. With this software, factories can reduce on-site commissioning time and labor and perform more efficient troubleshooting.



### MELSOFT Mirror (Currently available in Japan)

MELSOFT Mirror enables simulation of the entire control system on the shop floor. Efficiently simulate control logic, including I/O and inter-stage processes, for large systems without using physical devices, regardless of location or number of people. This enables front-loading of the development process and accelerates development.

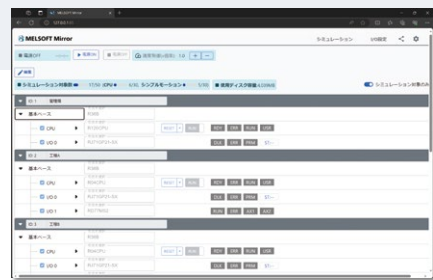

## Image processing software

### MELSOFT VIXIO NEW

MELSOFT VIXIO automates the visual inspection. Functions required for visual inspection systems can be easily created without programming. In addition, by setting up communication with the MELSEC iQ-R and iQ-F Series, visual inspection results are automatically linked to data held by the programmable controller for easy traceability.

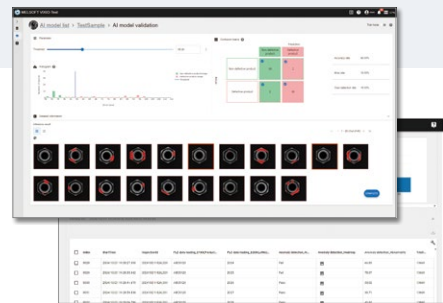

## Data analysis software

### MELSOFT MaiLab

MELSOFT MaiLab is a data science tool that further improves manufacturing such as predictive maintenance and labor saving by replacing human “intuition” and “experience” with digital technology. This intuitive setup tool enables visualization of data, offline analysis, and real-time diagnosis without requiring technical knowledge.

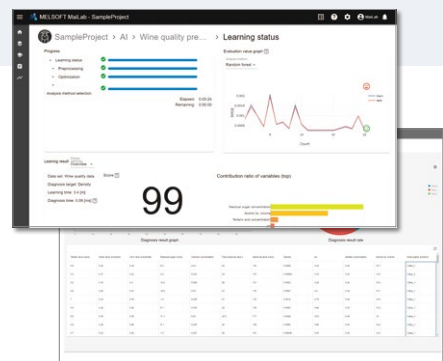

CPU

I/O

Analog/  
temperature input/  
temperature control

Motor/  
positioning

High-speed counter/  
isolated pulse/  
flexible high-speed I/O

FFGA

Network

Advanced  
Information

Energy  
measuring

Software

# Factory automation partner products

Various products that can be used with MELSEC programmable controllers are available. They help reduce the time required for panel designing, facility replacement, and so on.

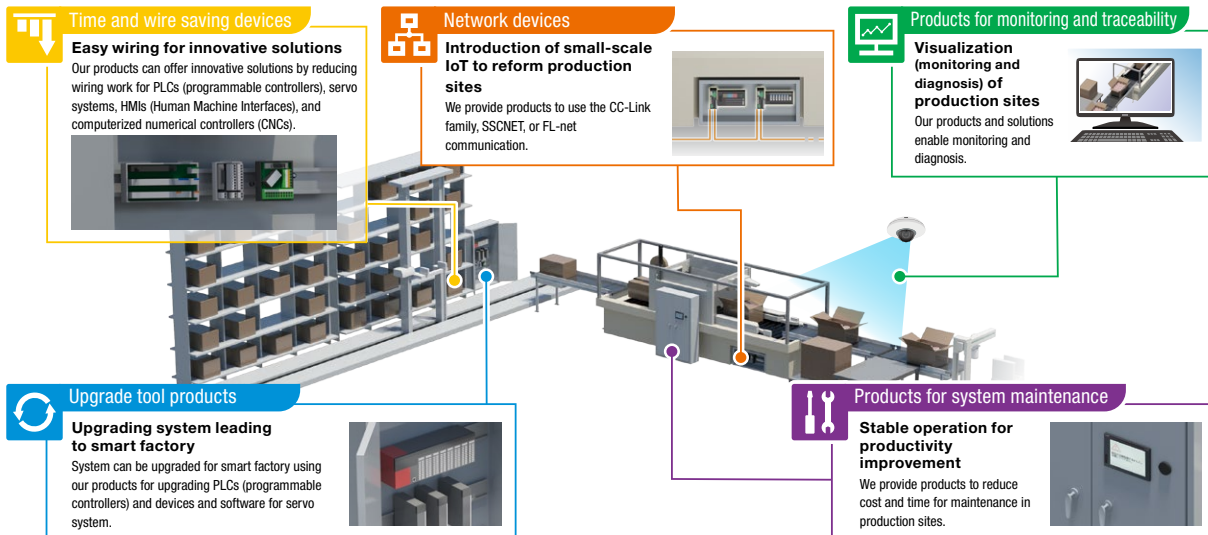

## CC-Link IE TSN - CC-Link Bridge Module FA3-BR1TC

This bridge module is used to seamlessly connect CC-Link to CC-Link IE TSN.

The bridge module operates as a remote station on CC-Link IE TSN, and as the master station on CC-Link.

- Control CC-Link devices from CC-Link IE TSN devices (Control CC-Link devices from CC-Link IE TSN devices)
- Using existing devices and wiring helps to cut costs and reduce construction time
- The existing CC-Link device configuration can be read as parameters and reflected to the CC-Link IE TSN automatic parameter setting. (The automatic detection function of the CC-Link system is supported.)



Item	FA3-BR1TC
<b>CC-Link IE TSN</b>	
Communication speed (bps)	1G/100M
Station type	Remote station
Certification class	Class B Ver.2.0
Communication cycle (us)	250 to 10000
Topology	Line topology/Star topology/Mixture of star and line topology/ Ring topology
<b>CC-Link</b>	
Transmission speed (bps)	Select from 156Kbps, 625Kbps, 2.5Mbps, 5Mbps, and 10Mbps
CC-Link version	Ver.2.00
Station type	Master station
Maximum number of connectable stations	64 stations



## FL-net (OPCN-2) interface module ER-1FL2-T

The FL-net is an open factory automation network that is standardized by Japan FA Open Systems Promotion Group. This network interconnects multiple devices such as programmable controllers, computerized numerical controllers (CNC), and personal computers manufactured by respective manufacturers, achieving control and monitoring.

- Since the FL-net does not need a master station, each node can be connected/disconnected to/from the network any time without affecting the communications with other nodes. Up to 254 devices\*1 can be connected
- Supported functions: Common-memory function, allowing all nodes to constantly share same data through cyclic transmission. Message-communication function, enabling nodes to exchange only required data when necessary



ER-1FL2-T product information

Item	ER-1FL2-T
<b>Transmission specifications</b>	
Protocol version	FL-net (OPCN-2) Ver. 3 Class 1 (equivalent to Ver. 2)*2
Transmission speed (bps)	100M/10M
Communication mode	Full-duplex/half-duplex (100M), half-duplex (10M)
Maximum segment length (m)	100 (length between hub and each node)*3
Maximum number of nodes in system (number)	254*1

\*1. Of these, only 249 can be used as control devices, and remaining five for failure diagnostics.  
 \*2. Version 1.00 equipment is not compatible and cannot be connected on the same network.  
 \*3. The maximum segment length of an Ethernet cable is 100 m but may have to be shorter depending on the environment where the cable is used. Consult the cable manufacturer for further information.

## MELSEC iQ-R Series-Compatible RFID Interface Module

Vital information can be collected and stored at various points on the production line as RF tags pass through the process along with the product. Reading RF tag information allows for traceability and real time monitoring via an Andon system or tablet.

- OMRON RFID System V680 Series
  - High-speed high-capacity data communication
  - Extensive test and measurement functions



RFID Interface Module product information

Item	OMRON RFID System V680 Series ER-1V680D□
No. of connectable reader/writers	1/2
Data transfer volume	2048 bytes max
No. of occupied I/O points	32
Transmission distance (m)	62.5*4

\*4. The distance between the RFID interface module and the antenna

# MITSUBISHI ELECTRIC ENGINEERING COMPANY LIMITED

NAGOYA ENGINEERING OFFICE | 1-9, Daiko-Minami, 1-Chome, Higashi-ku, Nagoya, Aichi 461-0047 Japan

Website



[www.mitsubishielectricengineering.com/sales/fa/meefan/](http://www.mitsubishielectricengineering.com/sales/fa/meefan/)

▶ Contact US



# Discover the latest information in Factory Automation

## Factory Automation Global website

Mitsubishi Electric Factory Automation provides a mix of services to support its customers worldwide. A consolidated global website is the main portal, offering a selection of support tools and a window to its local Mitsubishi Electric sales and support network.

### From here you can find:

- Overview of available factory automation products
- Library of downloadable literature
- Support tools such as online e-learning courses, terminology dictionary, etc.
- Global sales and service network portal
- Latest news related to Mitsubishi Electric factory automation

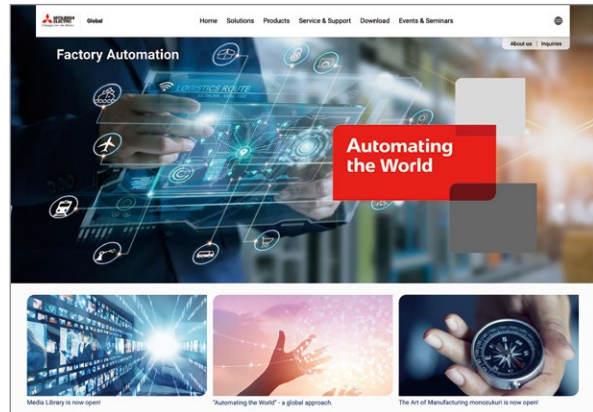

**Mitsubishi Electric Factory Automation  
Global website:  
[www.MitsubishiElectric.com/fa](http://www.MitsubishiElectric.com/fa)**

## Online e-learning

An extensive library of e-learning courses covering the factory automation product range has been prepared. Courses from beginner to advanced levels of difficulty are available in various languages.



### Beginner level

Designed for newcomers to Mitsubishi Electric Factory Automation products gaining a background of the fundamentals and an overview of various products related to the course.

### Basic to Advanced levels

These courses are designed to provide education at all levels. Various different features are explained with application examples providing an easy and informative resource for in-house company training.

Find information on products, factory automation, e-F@ctory solutions and other topics

## Follow us on Social Media

### YouTube



Mitsubishi Electric FA Global

### LinkedIn



Mitsubishi Electric FA Global

### X



Mitsubishi Electric FA Global  
[@Mitsubishi\\_FA](https://twitter.com/Mitsubishi_FA)

# Innovative next-generation, e-Manual

## e-Manual Viewer

The e-Manual viewer is a next-generation digital manual offered by Mitsubishi Electric that consolidates factory automation products manuals into an easy-to-use package with various useful features integrated into the viewer. The e-Manual allows multiple manuals to be cross-searched at once, further reducing time for setting up products and troubleshooting.

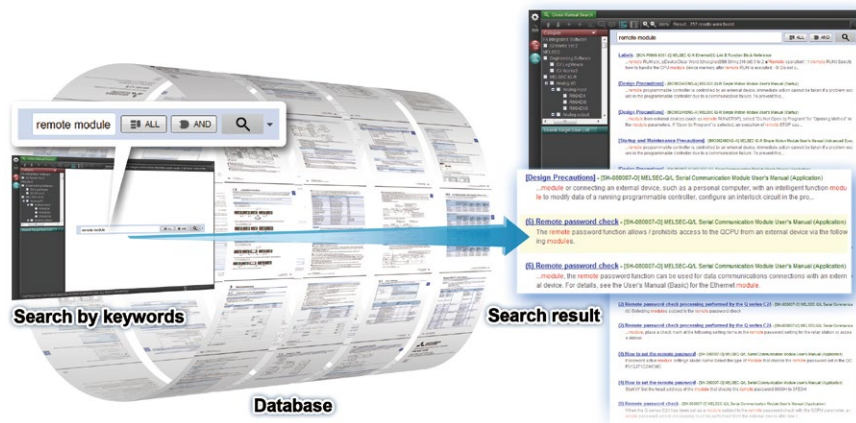

### Key features included

- One-stop database containing all required manuals, with local file cache
- Included with GX Works3 engineering software
- Also available in tablet version
- Easily download manuals all at once
- Multiple users can share the latest manuals and knowhow with document sharing function
- Directly port sample programs within manuals to GX Works3
- Downloaded manuals are usable offline



## e-Manual Create

e-Manual Create is software for converting word files and chm files to e-Manual documents. e-Manual Create allows users to directly refer to Mitsubishi Electric e-Manuals from user's customized device maintenance manuals and such, supporting quick troubleshooting and reduction in document creation process.

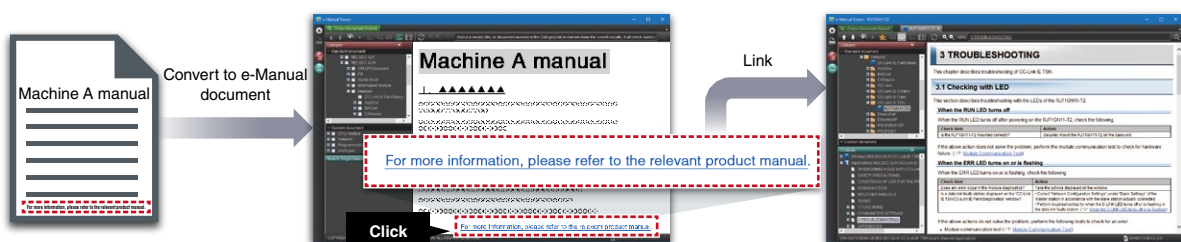

\* To obtain the Windows® version of e-Manual Viewer and e-Manual Create, please contact your local Mitsubishi Electric sales office or representative.

# CC-Link Partner Association (CLPA) - Actively promoting worldwide adoption of CC-Link Family

**Proactively supporting CC-Link Family, from promotion to specification development**

The CC-Link Partner Association (CLPA) was established to promote the worldwide adoption of the CC-Link open-field network. In 2018, CLPA has developed CC-Link IE TSN, the world's first open industrial network utilizes Time-Sensitive Networking (TSN) technology, which is an extension of standard Ethernet, to accelerate the construction of smart factories utilizing Industrial IoT (IIoT). By conducting promotional activities such as organizing trade shows and seminars, conducting conformance tests, and providing catalogs, brochures and website information, CLPA activities are successfully increasing the number of CC-Link partner manufacturers and CC-Link Family-compatible products. CLPA will provide a variety of development methods and develop a truly open industrial network on a global scale.



Seminar

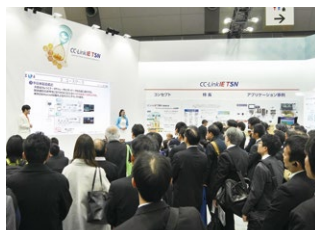

Trade show



Conformance testing lab

■ Visit the CLPA website for the latest CC-Link Family information.



**CLPA website**  
[www.cc-link.org/en](http://www.cc-link.org/en)



**CLPA Headquarters**

6F Ozone Front Bldg. 3-15-58 Ozone  
Kita-ku, Nagoya 462-0825, JAPAN  
TEL: +81-52-919-1588 FAX: +81-52-916-8655  
e-mail: [info@cc-link.org](mailto:info@cc-link.org)

## Global influence of CC-Link Family continues to spread

Centered in Japan, the CLPA has established bases of operations in 10 regions around the world. We lead the way in further opening up CC-Link Family network technology to the world. From helping vendors develop compatible products to consultation concerning system construction for our users, we provide a wide range of support services.

<b>Japan</b>	● CLPA Headquarters <b>CT</b>
<b>Asia-Pacific</b>	● CLPA-China <b>CT</b> ● CLPA-India      ● CLPC-ASEAN ● CLPA-Korea <b>CT</b> ● CLPA-Taiwan      ● CLPC-Thailand
<b>EMEA</b>	● CLPA-Europe <b>CT</b> ● CLPA-Turkey
<b>Americas</b>	● CLPA-Americas ● CLPA-Mexico

**CT** : Conformance testing lab

Regional Offices ▶



■ General specifications

Item	Specification					
Operating ambient temperature (°C)	0...55 (when a base unit other than an extended temperature range base unit is used)					
	0...60 (when an extended temperature range base unit is used)*1					
Storage ambient temperature (°C)	-25...75					
Operating ambient humidity (% RH)	5...95, non-condensing					
Storage ambient humidity (% RH)	5...95, non-condensing					
Vibration resistance	Compliant with JIS B 3502 and IEC 61131-2	-	Frequency	Constant acceleration	Half amplitude	Sweep count
		Under intermittent vibration	5...8.4 Hz	-	3.5 mm	10 times each in X, Y, Z directions
			8.4...150 Hz	9.8 m/s <sup>2</sup>	-	
		Under continuous vibration	5...8.4 Hz	-	1.75 mm	-
8.4...150 Hz	4.9 m/s <sup>2</sup>		-			
Shock resistance	Compliant with JIS B 3502 and IEC 61131-2 (147 m/s <sup>2</sup> , 3 times each in directions X, Y, Z)					
Operating atmosphere	No corrosive gases*2, no flammable gases, no excessive conductive dust					
Operating altitude*3 (m)	0...2000*4					
Installation location	Inside a control panel					
Overvoltage category*5	≤ II					
Pollution degree*6	≤ 2					

\*1. Enables standard MELSEC iQ-R Series modules to support extended operating ambient temperature of 0 to 60°C, ensuring the same performance as the standard operating ambient temperature (0 to 55°C). When requiring to use in an ambient temperature environment higher than 60°C, please consult your local Mitsubishi Electric representative.

\*2. The special coated product, which improves resistance to corrosive gas concentrations as specified in IEC 60721-3-3:1994 3C2, is available for the use in a corrosive gas environment. For more details on the special coated product, please consult your local Mitsubishi Electric representative.

\*3. Do not use or store the programmable controller under pressure higher than the atmospheric pressure of altitude 0 m. Doing so may cause malfunction. When using the programmable controller under pressure, please consult your local Mitsubishi Electric representative.

\*4. When used at an altitude higher than 2000 m, the upper limits of the permissible voltage and the operating ambient temperature become lower. Please consult your local Mitsubishi Electric representative.

\*5. This indicates the section of the power supply to which the equipment is assumed to be connected between the public electrical power distribution network and the machinery within premises. Category II applies to equipment for which electrical power is supplied from fixed facilities. The surge voltage withstand level for up to the rated voltage of 300 V is 2500 V.

\*6. This index indicates the degree to which conductive material is generated in terms of the environment in which the equipment is used. Pollution level 2 is when only non-conductive pollution occurs. A temporary conductivity caused by condensing must be expected occasionally.

■ Software operating environment\*7

Item	GX Works3	CW Workbench CW-Sim, CW-Sim Standalone	CW Configurator	MX MESInterface-R*8	MX OPC UA Module Configurator-R	PX Developer Monitor Tool
Personal computer	Microsoft® Windows® supported personal computer					
CPU	Intel® Core™ 2 Duo Processor 2 GHz or more*9	Intel® Core™ 2 Duo Processor 2 GHz or more*9	Intel® Core™ 2 Duo Processor 2 GHz or more*9	Intel® Core™ 2 Duo Processor 2 GHz or more*9*10	Intel® Core™ 2 Duo Processor 2 GHz or more*9	*7
Available hard disk capacity (at install)	22 GB or more	4 GB or more	5 GB or more	512 MB or more	300 MB or more	200 MB or more
Display resolution	1024 x 768 pixels or higher					
Required memory						
64-bit edition	2 GB or more recommended*11	2 GB or more	2 GB or more recommended	2 GB or more recommended*11	512 MB or more recommended*11	*7
32-bit edition	1 GB or more recommended*11	1 GB or more (2 GB or more recommended)	1 GB or more recommended	1 GB or more recommended*11*12	512 MB or more recommended*11	*7
OS (English version)						
Microsoft® Windows® 11 Home Operating System	●	●	●	-	●*13	●
Microsoft® Windows® 11 Pro Operating System	●	●	●	●	●*13	●
Microsoft® Windows® 11 Enterprise Operating System	●	●	●	●	●*13	●
Microsoft® Windows® 11 Education Operating System	●	●	●	-	●*13	●
Microsoft® Windows® 10 Home Operating System	●	●	●	●	●	●
Microsoft® Windows® 10 Pro Operating System	●	●	●	●	●	●
Microsoft® Windows® 10 Enterprise Operating System	●	●	●	●	●	●
Microsoft® Windows® 10 Education Operating System	●	●	●	●	●	●
Microsoft® Windows® 10 IoT Enterprise 2016 LTSB	●*13	●*13	●*13	-	-	●
Microsoft® Windows® 10 IoT Enterprise LTSC 2019	-	-	●*13	-	-	-

\*7. For details, please refer to the relevant manuals.

\*8. Software operating environment when installing the MES interface function configuration tool.

\*9. When used with Windows® 11, a 64-bit compatible processor with 2 cores or more or System on a Chip (SoC) is required.

\*10. When used with Windows® 11, Intel® Core™ i3-13 2 GHz or more is recommended.

\*11. When used with Windows® 11, 4 GB or more is recommended.

\*12. For the DB Connection Service and DB Connection Service Configuration Tool, 2 GB or more is recommended.

\*13. Supports only 64-bit edition.

# Product list

Please check product compatibility and restrictions in the related manual(s) before purchasing.

## ■ Base units

Product name	Model	Outline
Main base	R33B	3 slots, for MELSEC iQ-R Series modules
	R35B	5 slots, for MELSEC iQ-R Series modules
	R38B	8 slots, for MELSEC iQ-R Series modules
	R312B	12 slots, for MELSEC iQ-R Series modules
Slim type main base	R32SB <b>NEW</b>	2 slots, for MELSEC iQ-R Series modules
	R33SB <b>NEW</b>	3 slots, for MELSEC iQ-R Series modules
	R35SB <b>NEW</b>	5 slots, for MELSEC iQ-R Series modules
Redundant power supply main base	R310RB	10 slots, for MELSEC iQ-R Series modules, redundant system (remote I/O)
Extended temperature range main base	R310B-HT	10 slots, for MELSEC iQ-R Series modules, operating ambient temperature: 0...60°C
Extended temperature range redundant power supply main base	R38RB-HT	8 slots, for MELSEC iQ-R Series modules, redundant system (remote I/O) operating ambient temperature: 0...60°C
Extension base	R65B	5 slots, for MELSEC iQ-R Series modules
	R68B	8 slots, for MELSEC iQ-R Series modules
	R612B	12 slots, for MELSEC iQ-R Series modules
Redundant power supply extension base	R610RB	10 slots, for MELSEC iQ-R Series modules, redundant system (local I/O, remote I/O)
Redundant extension base	R68WRB	8 slots, for MELSEC iQ-R Series modules, redundant system (local I/O)
Extended temperature range extension base	R610B-HT	10 slots, for MELSEC iQ-R Series modules, operating ambient temperature: 0...60°C
Extended temperature range redundant power supply extension base	R68RB-HT	8 slots, for MELSEC iQ-R Series modules, redundant system (local I/O, remote I/O) operating ambient temperature: 0...60°C
Extended temperature range redundant extension base	R66WRB-HT	6 slots, for MELSEC iQ-R Series modules, redundant system (local I/O) operating ambient temperature: 0...60°C
RQ extension base	RQ65B	5 slots, for MELSEC-Q Series modules
	RQ68B	8 slots, for MELSEC-Q Series modules
	RQ612B	12 slots, for MELSEC-Q Series modules
Extension cable	RC06B	0.6 m cable for extension and RQ extension base units
	RC12B	1.2 m cable for extension and RQ extension base units
	RC30B	3 m cable for extension and RQ extension base units
	RC50B	5 m cable for extension and RQ extension base units
	RC100B	10 m cable for extension and RQ extension base units
DIN rail mounting adapter	R6DIN1	For main and extension base units
	Q6DIN1	For RQ68B/RQ612B
	Q6DIN2	For RQ65B
	Q6DIN1A	For RQ extension base units (with vibration-proofing bracket sets)
Blank cover	RG60	For I/O slots of main and extension base units
	QG60	For I/O slots of RQ extension base units

## ■ Power supply modules

Product name	Model	Outline
Power supply	R61P	AC power supply, input: 100...240 V AC, output: 5 V DC/6.5 A
	R62P	AC power supply, input: 100...240 V AC, output: 5 V DC/3.5 A, 24 V DC/0.6 A
	R63P	DC power supply, input: 24 V DC, output: 5 V DC/6.5 A
	R64P	AC power supply, input: 100...240 V AC, output: 5 V DC/9 A
	R69P	DC power supply, input: 24 V DC, output: 5 V DC/9 A
Slim type power supply	R61SP <b>NEW</b>	AC power supply, input: 100...240 V AC, output: 5 V DC/2.5 A (can only be installed on the slim type main base)
Redundant power supply	R63RP	DC power supply, input: 24 V DC, output: 5 V DC/6.5 A, for redundant power supply system
	R64RP	AC power supply, input: 100...240 V AC, output: 5 V DC/9 A, for redundant power supply system
	R69RP	DC power supply, input: 24 V DC, output: 5 V DC/9 A, for redundant power supply system

## ■ CPU modules

Product name	Model	Outline
Programmable controller CPU	R00CPU	Program capacity: 10K steps, basic operation processing speed (LD instruction): 31.3 ns
	R01CPU	Program capacity: 15K steps, basic operation processing speed (LD instruction): 31.3 ns
	R02CPU	Program capacity: 20K steps, basic operation processing speed (LD instruction): 3.92 ns
	R04CPU	Program capacity: 40K steps, basic operation processing speed (LD instruction): 0.98 ns
	R08CPU	Program capacity: 80K steps, basic operation processing speed (LD instruction): 0.98 ns
	R16CPU	Program capacity: 160K steps, basic operation processing speed (LD instruction): 0.98 ns
	R32CPU	Program capacity: 320K steps, basic operation processing speed (LD instruction): 0.98 ns
	R120CPU	Program capacity: 1200K steps, basic operation processing speed (LD instruction): 0.98 ns
	R04ENCPU	CC-Link IE embedded, program capacity: 40K steps, basic operation processing speed (LD instruction): 0.98 ns
	R08ENCPU	CC-Link IE embedded, program capacity: 80K steps, basic operation processing speed (LD instruction): 0.98 ns
	R16ENCPU	CC-Link IE embedded, program capacity: 160K steps, basic operation processing speed (LD instruction): 0.98 ns
	R32ENCPU	CC-Link IE embedded, program capacity: 320K steps, basic operation processing speed (LD instruction): 0.98 ns
R120ENCPU	CC-Link IE embedded, program capacity: 1200K steps, basic operation processing speed (LD instruction): 0.98 ns	
Motion CPU	R16MTCPU	Max. number of control axes: 16, operation cycle: 0.222 ms or more, SSCNETⅢ/H-compatible
	R32MTCPU	Max. number of control axes: 32, operation cycle: 0.222 ms or more, SSCNETⅢ/H-compatible
	R64MTCPU	Max. number of control axes: 64, operation cycle: 0.222 ms or more, SSCNETⅢ/H-compatible
Safety CPU	R08SFCPU-SET	Program capacity: 80K steps (40K steps for safety programs <sup>*1</sup> ) basic operation processing speed (LD instruction): 0.98 ns
	R16SFCPU-SET	Program capacity: 160K steps (40K steps for safety programs <sup>*1</sup> ) basic operation processing speed (LD instruction): 0.98 ns
	R32SFCPU-SET	Program capacity: 320K steps (40K steps for safety programs <sup>*1</sup> ) basic operation processing speed (LD instruction): 0.98 ns
	R120SFCPU-SET	Program capacity: 1200K steps (40K steps for safety programs <sup>*1</sup> ) basic operation processing speed (LD instruction): 0.98 ns
Process CPU	R08PCPU	Program capacity: 80K steps, basic operation processing speed (LD instruction): 0.98 ns
	R16PCPU	Program capacity: 160K steps, basic operation processing speed (LD instruction): 0.98 ns
	R32PCPU	Program capacity: 320K steps, basic operation processing speed (LD instruction): 0.98 ns
	R120PCPU	Program capacity: 1200K steps, basic operation processing speed (LD instruction): 0.98 ns
SIL2 process CPU	R08PSFCPU-SET	Program capacity: 80K steps (40K steps for safety programs <sup>*1</sup> ) basic operation processing speed (LD instruction): 0.98 ns
	R16PSFCPU-SET	Program capacity: 160K steps (40K steps for safety programs <sup>*1</sup> ) basic operation processing speed (LD instruction): 0.98 ns
	R32PSFCPU-SET	Program capacity: 320K steps (40K steps for safety programs <sup>*1</sup> ) basic operation processing speed (LD instruction): 0.98 ns
	R120PSFCPU-SET	Program capacity: 1200K steps (40K steps for safety programs <sup>*1</sup> ) basic operation processing speed (LD instruction): 0.98 ns
Redundant function	R6RFM	By combining with a process CPU module or SIL2 process CPU module, a redundant control system can be realized.
C Controller	R12CCPU-V	Endian format: little endian, OS: VxWorks® Version 6.9 <sup>*2</sup>
C intelligent function	RD55UP06-V	C/C++ program execution, RAM: 128 MB (CW Workbench/Wind River® Workbench 3.3 <sup>*2</sup> /TimeStorm®/Visual Studio® are required for programming, setting and monitoring is done using GX Works3.)
	RD55UP12-V	C/C++ program execution, RAM: 1 GB (CW Workbench/Wind River® Workbench 3.3 <sup>*2</sup> /TimeStorm®/Visual Studio® are required for programming, setting and monitoring is done using GX Works3.)
MELSECWinCPU	R102WCPU-W	OS: Windows® 10 IoT Enterprise LTSC 2019, RAM: 4 GB
SD memory card <sup>*3</sup>	NZ1MEM-2GBSD	SD memory card, 2 GB
	NZ1MEM-4GBSD	SDHC memory card, 4 GB
	NZ1MEM-8GBSD	SDHC memory card, 8 GB
	NZ1MEM-16GBSD	SDHC memory card, 16 GB
Extended SRAM cassette <sup>*4</sup>	NZ2MC-1MBS	1 MB
	NZ2MC-2MBS	2 MB
	NZ2MC-2MBSE	2 MB, ECC type
	NZ2MC-4MBS	4 MB
	NZ2MC-8MBS	8 MB
	NZ2MC-8MBSE	8 MB, ECC type
NZ2MC-16MBS	16 MB	
Battery-less option cassette <sup>*4</sup>	NZ1BLC	Retain file register and latch device/label memory data without using a battery.
Battery	Q6BAT <sup>*5</sup>	Replacement battery
	Q7BATN <sup>*5</sup>	Replacement large-capacity battery
	Q7BATN-SET <sup>*5</sup>	Large-capacity battery with holder for installing CPU
	FX3U-32BL <sup>*6</sup>	Long-term backup battery for clock data

\*1. Up to 40K steps of the program capacity can be used for safety programs.

\*2. VxWorks® 6.9 and Wind River® Workbench 3.3 are products of Wind River Systems, Inc. in the United States.

For any inquiries on products of Wind River Systems, Inc. in the United States, please refer to the manuals of Wind River Systems products or contact Wind River Systems, Inc. in Japan. Please visit the website below.

[www.windriver.com](http://www.windriver.com)

\*3. Mitsubishi Electric shall not guarantee the operation of any third-party products.

\*4. For supported CPU modules, refer to page 57.

\*5. Not supported for R00CPU, R01CPU, R02CPU.

\*6. Supports R00CPU, R01CPU, R02CPU, and R102WCPU-W.

## ■ I/O modules

Product name	Model	Outline
DC input	RX40C7-TS	16 points, 24 V DC (input current: 7.0 mA), positive/negative common shared spring-clamp terminal block
	RX40C7	16 points, 24 V DC (input current: 7.0 mA), positive/negative common shared screw terminal block
	RX41C4-TS	32 points, 24 V DC (input current: 4.0 mA), positive/negative common shared spring-clamp terminal block
	RX41C4	32 points, 24 V DC (input current: 4.0 mA), positive/negative common shared 40-pin connector
	RX42C4	64 points, 24 V DC (input current: 4.0 mA), positive/negative common shared 40-pin connector (2x)
	RX70C4	16 points, 5 V DC (input current: 1.7 mA), 12 V DC (input current: 4.8 mA) positive/negative common shared, screw terminal block
	RX71C4	32 points, 5 V DC (input current: 1.7 mA), 12 V DC (input current: 4.8 mA) positive/negative common shared, 40-pin connector
	RX72C4	64 points, 5 V DC (input current: 1.7 mA), 12 V DC (input current: 4.8 mA) positive/negative common shared, 40-pin connector (2x)
DC high-speed input	RX40PC6H	16 points, 24 V DC (input current: 6.0 mA), min. response time: 5 $\mu$ s, positive common screw terminal block
	RX40NC6H	16 points, 24 V DC (input current: 6.0 mA), min. response time: 5 $\mu$ s, negative common screw terminal block
	RX41C6HS	32 points, 24 V DC (input current: 6.0 mA), min. response time: 1 $\mu$ s positive/negative common shared, 40-pin connector
	RX61C6HS	32 points, 5 V DC (input current: 6.0 mA), min. response time: 1 $\mu$ s positive/negative common shared, 40-pin connector
DC input with diagnostic functions	RX40NC6B	16 points, 24 V DC (input current: 6.0 mA), negative common, screw terminal block
DC input with safety functions	RX40NC6S-TS <b>NEW</b>	Single wiring: 16 points; double wiring: 8 points; 24 V DC, response time: 1...70 ms negative common, spring-clamp terminal block
AC input	RX28	8 points, 100...240 V AC (50/60 Hz), screw terminal block
	RX10-TS	16 points, 100...120 V AC (50/60 Hz), spring-clamp terminal block
	RX10	16 points, 100...120 V AC (50/60 Hz), screw terminal block
Transistor output	RY40NT5P-TS	Transistor (sink) output: 16 points, 12/24 V DC, spring-clamp terminal block
	RY40NT5P	Transistor (sink) output: 16 points, 12/24 V DC, screw terminal block
	RY41NT2P-TS	Transistor (sink) output: 32 points, 12/24 V DC, spring-clamp terminal block
	RY41NT2P	Transistor (sink) output: 32 points, 12/24 V DC, 40-pin connector
	RY42NT2P	Transistor (sink) output: 64 points, 12/24 V DC, 40-pin connector (2x)
	RY40PT5P-TS	Transistor (source) output: 16 points, 12/24 V DC, spring-clamp terminal block
	RY40PT5P	Transistor (source) output: 16 points, 12/24 V DC, screw terminal block
	RY41PT1P-TS	Transistor (source) output: 32 points, 12/24 V DC, spring-clamp terminal block
	RY41PT1P	Transistor (source) output: 32 points, 12/24 V DC, 40-pin connector
Transistor high-speed output	RY41NT2H	Transistor (sink) output: 32 points, 5/12/24 V DC, min. response time: 2 $\mu$ s 40-pin connector
	RY41PT2H	Transistor (source) output: 32 points, 5/12/24 V DC, min. response time: 2 $\mu$ s 40-pin connector
Transistor output with diagnostic functions	RY40PT5B	Transistor (source) output: 16 points, 24 V DC, screw terminal block
Transistor output with safety functions	RY48PT20S-TS <b>NEW</b>	Single wiring: 8 points; double wiring: 4 points, 24 V DC (2 A/point, 16 A/common) source + source, spring-clamp terminal block
Relay output	RY18R2A	8 points, 24 V DC 2 A/point, 240 V AC 2 A/point, screw terminal block
	RY10R2-TS	16 points, 24 V DC 2 A/point, 240 V AC 2 A/point, spring-clamp terminal block
	RY10R2	16 points, 24 V DC 2 A/point, 240 V AC 2 A/point, screw terminal block
Triac output	RY20S6	16 points, 100...240 V AC, screw terminal block
I/O combined	RH42C4NT2P	DC input: 32 points, 24 V DC (input current: 4.0 mA), positive/negative common shared Transistor (sink) output: 32 points, 12/24 V DC, 40-pin connector (2x)



### ■ Analog/temperature input/temperature control modules

Product name	Model	Outline
Analog input	R60AD4	4 channels for voltage/current inputs -10...10 V DC/-32000...32000, 0...20 mA DC/0...32000, 80 μs/channel, screw terminal block
	R60ADV8	8 channels for voltage inputs -10...10 V DC/-32000...32000, 80 μs/channel, screw terminal block
	R60ADI8	8 channels for current inputs 0...20 mA DC/0...32000, 80 μs/channel, screw terminal block
	R60ADI8-HA	8 channels for current inputs 4...20 mA DC/0...32000, 80 ms/8 channels, HART® communication, spring-clamp terminal block
	R60AD8-G	8 channels for voltage/current inputs, channel isolated -10...10 V DC/-32000...32000, 0...20 mA DC/0...32000, 10 ms/channel, 40-pin connector
	R60AD16-G	16 channels for voltage/current inputs, channel isolated -10...10 V DC/-32000...32000, 0...20 mA DC/0...32000, 10 ms/channel 40-pin connector (2x)
High-speed analog input	R60ADH4	4 channels for voltage/current inputs -10...10 V DC/-32000...32000, 0...20 mA DC/0...32000, 1 μs/CH, screw terminal block
Channel isolated analog input	R60AD6-DG	6 channels for current inputs, channel isolated 4...20 mA DC (2-wire transmitter is connected)/0...32000, 0...20 mA DC/0...32000, 10 ms/channel 40-pin connector
Analog output	R60DA4	4 channels for voltage/current outputs -32000...32000/-10...10 V DC, 0...32000/0...20 mA DC, 80 μs/channel, screw terminal block
	R60DAV8	8 channels for voltage outputs -32000...32000/-10...10 V DC, 80 μs/channel, screw terminal block
	R60DAI8	8 channels for current outputs 0...32000/0...20 mA DC, 80 μs/channel, screw terminal block
	R60DA8-G	8 channels for voltage/current outputs, channel isolated -32000...32000/-12...12 V DC, 0...32000/0...20 mA DC, 1 ms/channel, 40-pin connector
	R60DA16-G	16 channels for voltage/current outputs, channel isolated -32000...32000/-12...12 V DC, 0...32000/0...20 mA DC, 1 ms/channel 40-pin connector (2x)
High-speed analog output	R60DAH4	4 channels for voltage/current outputs -32000...32000/-10...10 V DC, 0...32000/0...20 mA DC, 1 μs/channel, screw terminal block
SIL2 analog control output	RY40PT5B-AS	Transistor (source) output: 16 points, 24 V DC (max. load current: 0.5 A/point), screw terminal block
Temperature input	R60TD8-G	Thermocouple (B, R, S, K, E, J, T, N), 8 channels for inputs, channel isolated, 30 ms/channel, 40-pin connector
	R60RD8-G	RTD (Pt100, JPt100, Ni100, Pt50), 8 channels for inputs, channel isolated, 10 ms/channel 40-pin connector
Temperature control	R60TCTR2T2-TS	Thermocouple (B, R, S, K, E, J, T, N, U, L, PLII, W5Re/W26Re), 4 channels for inputs (2 channels can also be used for RTD inputs), spring-clamp terminal block type
	R60TCTR2T2	Thermocouple (B, R, S, K, E, J, T, N, U, L, PLII, W5Re/W26Re), 4 channels for inputs (2 channels can also be used for RTD inputs), screw terminal block
	R60TCRT4-TS	RTD (Pt100, JPt100), 4 channels for inputs, spring-clamp terminal block type
	R60TCRT4	RTD (Pt100, JPt100), 4 channels for inputs, screw terminal block
	R60TCTR2T2BW	Thermocouple (B, R, S, K, E, J, T, N, U, L, PLII, W5Re/W26Re), 4 channels for inputs (2 channels can also be used for RTD inputs), heater disconnection detection, screw terminal block
	R60TCRT4BW	RTD (Pt100, JPt100), 4 channels for inputs, heater disconnection detection, screw terminal block

### ■ Motion/positioning modules

Product name	Model	Outline
Motion	RD78G4	Max. number of control axes: 4, linear/circular/helical interpolation, CC-Link IE TSN-compatible
	RD78G8	Max. number of control axes: 8, linear/circular/helical interpolation, CC-Link IE TSN-compatible
	RD78G16	Max. number of control axes: 16, linear/circular/helical interpolation, CC-Link IE TSN-compatible
	RD78G32	Max. number of control axes: 32, linear/circular interpolation, CC-Link IE TSN-compatible
	RD78G64	Max. number of control axes: 64, linear/circular interpolation, CC-Link IE TSN-compatible
	RD78GHV	High-performance type, max. number of control axes: 128, linear/circular interpolation, CC-Link IE TSN-compatible
	RD78GHW	High-performance type, max. number of control axes: 256, linear/circular interpolation, CC-Link IE TSN-compatible
Simple motion	RD77GF4	Max. number of control axes: 4, linear/circular/helical interpolation, advanced synchronous control CC-Link IE Field Network-compatible
	RD77GF8	Max. number of control axes: 8, linear/circular/helical interpolation, advanced synchronous control CC-Link IE Field Network-compatible
	RD77GF16	Max. number of control axes: 16, linear/circular/helical interpolation, advanced synchronous control CC-Link IE Field Network-compatible
	RD77GF32	Max. number of control axes: 32, linear/circular/helical interpolation, advanced synchronous control CC-Link IE Field Network-compatible
	RD77MS2	Max. number of control axes: 2, linear/circular interpolation, advanced synchronous control SSCNETⅢ/H-compatible
	RD77MS4	Max. number of control axes: 4, linear/circular/helical interpolation, advanced synchronous control SSCNETⅢ/H-compatible
	RD77MS8	Max. number of control axes: 8, linear/circular/helical interpolation, advanced synchronous control SSCNETⅢ/H-compatible
	RD77MS16	Max. number of control axes: 16, linear/circular/helical interpolation, advanced synchronous control SSCNETⅢ/H-compatible
Positioning	RD75P2	Open collector output: 2 axes, max. output: 200k pulse/s, linear/circular interpolation
	RD75P4	Open collector output: 4 axes, max. output: 200k pulse/s, linear/circular/helical interpolation
	RD75D2	Differential driver output: 2 axes, max. output: 5M pulse/s, linear/circular interpolation
	RD75D4	Differential driver output: 4 axes, max. output: 5M pulse/s, linear/circular/helical interpolation

## ■ High-speed counter/channel isolated pulse input/flexible high-speed I/O modules

Product name	Model	Outline
High-speed counter	RD62P2	5/12/24 V DC input: 2 channels; Max. counting speed: 200k pulse/s; External output: transistor (sink)
	RD62P2E	5/12/24 V DC input: 2 channels; Max. counting speed: 200k pulse/s; External output: transistor (source)
	RD62D2	Differential input: 2 channels; Max. counting speed: 8M pulse/s; External output: transistor (sink)
Channel isolated pulse input	RD60P8-G	5/12...24 V DC input: 8 channels; Channel isolated; Max. counting speed: 30k pulse/s
Flexible high-speed I/O control	RD40PD01	[Input] 12 points (5/24 V DC/differential); Max. counting speed: 8M pulse/s (differential) [Output] 14 points (5...24 V DC: 8 points; Differential: 6 points); Max. output: 8M pulse/s (differential)

## ■ CC-Link IE TSN-compatible FPGA modules

Product name	Model	Outline
Main module		
DC input/output	NZ2GN2S-D41P01	[Input] 48 points; 24 V DC; Response time: 1 μs or less; Positive/negative common shared [Output] 48 points; 5/12/24 V DC; Sink
Differential input/output	NZ2GN2S-D41D01	[Differential (RS-422) input] 24 points; Response time: 0.2 μs or less [Differential (RS-422) output] 24 points [Differential (RS-485) input/output] 3 points
DC input/output, differential input/output	NZ2GN2S-D41PD02	[Input] 32 points; 24 V DC; Response time: 1 μs or less; Positive/negative common shared [Output] 32 points; 5/12/24 V DC; Sink [Differential (RS-422) input] 8 points; Response time: 0.2 μs or less [Differential (RS-422) output] 8 points [Differential (RS-485) input/output] 1 point
Extension module		
DC input/output	NZ2EX2S-D41P01	[Input] 48 points; 24 V DC; Response time: 1 μs or less; Positive/negative common shared [Output] 48 points; 5/12/24 V DC; Sink
Differential input/output	NZ2EX2S-D41D01	[Differential (RS-422) input] 24 points; Response time: 0.2 μs or less [Differential (RS-422) output] 24 points [Differential (RS-485) input/output] 3 points
Analog input/output	NZ2EX2S-D41A01	[Input] 36 points; -9.9...9.9 V DC, -19.8...19.8 mA DC [Output] 6 points; -9.9...9.9 V DC, 0.2...19.8 mA DC

## ■ Network modules

DB ...Co-branded product\*1

Product name	Model	Outline
CC-Link IE TSN master/local	RJ71GN11-T2	1 Gbps/100 Mbps, master/local station
CC-Link IE TSN Plus master/local	RJ71GN11-EIP	1 Gbps/100 Mbps, master/local station, EtherNet/IP™-compatible
CC-Link IE Controller Network	RJ71GP21-SX	1 Gbps, fiber-optic cable, control/normal station (standard type)
	RJ71GP21S-SX	1 Gbps, fiber-optic cable, control/normal station (with external power supply)
CC-Link IE Field Network master/local	RJ71GF11-T2	1 Gbps, master/local station
CC-Link IE Field Network remote head	RJ72GF15-T2	1 Gbps, intelligent device station
CC-Link system master/local	RJ61BT11	Max. 10 Mbps, master/local station, CC-Link Ver.2-compatible
AnyWireASLINK master	RJ51AW12AL <span style="background-color: #0056b3; color: white; padding: 0 2px;">DB</span>	AnyWireASLINK system-compatible, master station
MELSECNET/H network	RJ71LP21-25	Optical loop type, max. 25 Mbps SI/H-PCF/broadband H-PCF/QSI/broadband silica glass optical fiber cable control/normal station (PLC to PLC network)
	RJ71BR11	Coaxial bus type, 10 Mbps, coaxial cable, control/normal station (PLC to PLC network)
Terminating resistor	A6RCON-R75	Terminating resistor for MELSECNET/H coaxial bus system, 75 Ω
BACnet®	RJ71BAC96 <span style="background-color: #0056b3; color: white; padding: 0 2px;">DB</span>	BACnet® system-compatible, controller/workstation
EtherNet/IP network interface	RJ71EIP91	EtherNet/IP™ system-compatible, scanner
CIP Safety™	RJ71SEIP91-T4 <span style="background-color: #0056b3; color: white; padding: 0 2px;">DB</span>	CIP Safety™ system-compatible, scanner
CANopen®	RJ71CN91	CANopen® system-compatible, NMT master/NMT slave
DeviceNet master/slave	RJ71DN91	DeviceNet® system-compatible, master/slave
PROFIBUS-DP	RJ71PB91V	PROFIBUS® system-compatible, DP master/slave
PROFINET IO	RJ71PN92	PROFINET IO Controller
	RJ71PN93	PROFINET IO Device
GP-IB interface	RJ71GB91	GP-IB system-compatible, controller/device
Ethernet interface (CC-Link IE embedded)	RJ71EN71	1 Gbps/100 Mbps/10 Mbps: 2 ports Multi-network connectivity (EtherNet/CC-Link IE Field/CC-Link IE Controller Network (twisted pair cable))
	RJ71C24	Max. 230.4 kbps, RS-232: 1 channel, RS-422/485: 1 channel
Serial communication	RJ71C24-R2	Max. 230.4 kbps, RS-232: 2 channels
	RJ71C24-R4	Max. 230.4 kbps, RS-422/485: 2 channels

\*1. General specifications and product guarantee conditions for co-branded products may vary from those of general MELSEC products.  
For more information, please refer to the relevant product manuals or contact your local Mitsubishi Electric sales office or representative.

■ CC-Link IE TSN-compatible block-type remote modules

Product name	Model	Outline
Block-type remote module		
DC input	NZ2GN2S1-16D	16 points; 24 V DC; Response time: 0...70 ms; Positive/negative common shared Spring-clamp terminal block; 1-wire
	NZ2GN2S1-32D	32 points; 24 V DC; Response time: 0...70 ms; Positive/negative common shared Spring-clamp terminal block; 1-wire
	NZ2GN2B1-16D	16 points; 24 V DC; Response time: 0...70 ms; Positive/negative common shared Screw terminal block; 1-wire
	NZ2GN2B1-32D	32 points; 24 V DC; Response time: 0...70 ms; Positive/negative common shared Screw terminal block; 1-wire
	NZ2GNCE3-32D	32 points; 24 V DC; Response time: 0...70 ms; Positive common; Sensor connector (e-CON); 3-wire
	NZ2GNCF1-32D	32 points; 24 V DC; Response time: 0...70 ms; Positive/negative common shared; 40-pin connector, 1-wire
Transistor output	NZ2GN2S1-16T	16 points; 12/24 V DC; Sink; Spring-clamp terminal block; 1-wire
	NZ2GN2S1-16TE	16 points; 12/24 V DC; Source; Spring-clamp terminal block; 1-wire
	NZ2GN2S1-32T	32 points; 12/24 V DC; Sink; Spring-clamp terminal block; 1-wire
	NZ2GN2S1-32TE	32 points; 12/24 V DC; Source; Spring-clamp terminal block; 1-wire
	NZ2GN2B1-16T	16 points; 12/24 V DC; Sink; Screw terminal block; 1-wire
	NZ2GN2B1-16TE	16 points; 12/24 V DC; Source; Screw terminal block; 1-wire
	NZ2GN2B1-32T	32 points; 12/24 V DC; Sink; Screw terminal block; 1-wire
	NZ2GN2B1-32TE	32 points; 12/24 V DC; Source; Screw terminal block; 1-wire
	NZ2GNCF1-32T	32 points; 12/24 V DC; Sink; 40-pin connector; 1-wire
	I/O combined	NZ2GN2S1-32DT
NZ2GN2S1-32DTE		[Input] 16 points; 24 V DC; Response time: 0...70 ms; Negative common [Output] 16 points; 24 V DC; Source Spring-clamp terminal block; 1-wire
NZ2GN2B1-32DT		[Input] 16 points; 24 V DC; Response time: 0...70 ms; Positive common [Output] 16 points; 24 V DC; Sink Screw terminal block; 1-wire
NZ2GN2B1-32DTE		[Input] 16 points; 24 V DC; Response time: 0...70 ms; Negative common [Output] 16 points; 24 V DC; Source Screw terminal block; 1-wire
NZ2GNCE3-32DT		[Input] 16 points; 24 V DC; Response time: 0...70 ms; Positive common [Output] 16 points; 24 V DC; Sink Sensor connector (e-CON); 3-wire
Analog input	NZ2GN2S-60AD4	4 channels; input: -10...10 V DC; 0...20 mA DC Conversion speed: 200 μs/channel; Spring-clamp terminal block
	NZ2GN2B-60AD4	4 channels; input: -10...10 V DC; 0...20 mA DC Conversion speed: 200 μs/channel; Screw terminal block
Analog output	NZ2GN2S-60DA4	4 channels; output: -10...10 V DC; 0...20 mA DC Conversion speed: 200 μs/channel; Spring-clamp terminal block
	NZ2GN2B-60DA4	4 channels; output: -10...10 V DC; 0...20 mA DC Conversion speed: 200 μs/channel; Screw terminal block
Waterproof/dustproof type (IP67) remote module		
DC input	NZ2GN12A4-16D	16 points; 24 V DC; Response time: 0...70 ms; Positive common Waterproof connector; 2- to 4-wire
	NZ2GN12A4-16DE	16 points; 24 V DC; Response time: 0...70 ms; Negative common Waterproof connector; 2- to 4-wire
Transistor output	NZ2GN12A2-16T	16 points; 12/24 V DC; Sink; Waterproof connector; 2-wire
	NZ2GN12A2-16TE	16 points; 12/24 V DC; Source; Waterproof connector; 2-wire
I/O combined	NZ2GN12A42-16DT	[Input] 8 points; 24 V DC; Response time: 0...70 ms; Positive common; 2- to 4-wire [Output] 8 points; 12/24 V DC; Sink; 2-wire Waterproof connector
	NZ2GN12A42-16DTE	[Input] 8 points; 24 V DC; Response time: 0...70 ms; Negative common; 2- to 4-wire [Output] 8 points; 12/24 V DC; Source; 2-wire Waterproof connector
Block-type remote module with safety functions		
DC input	NZ2GNSS2-8D	Single wiring: 8 points; Double wiring: 4 points; 24 V DC; Response time: 1...70 ms; Negative common; Spring-clamp terminal block; 2-wire
Transistor output	NZ2GNSS2-8TE	Single wiring: 8 points; Double wiring: 4 points; 24 V DC; Source + source; Spring-clamp terminal block; 2-wire
I/O combined	NZ2GNSS2-16DTE	[Input] Single wiring: 8 points; Double wiring: 4 points; 24 V DC; Response time: 1...70 ms; Negative common [Output] Single wiring: 8 points; Double wiring: 4 points; 24 V DC; Source + source Spring-clamp terminal block; 2-wire
Waterproof/dustproof type (IP67) I/O combined	NZ2GNS12A2-14DT	[Input] Single wiring: 12 points; Double wiring: 6 points; 24 V DC; Response time: 1...70 ms; Negative common [Output] Single wiring: not possible; Double wiring: 2 points; 24 V DC; Source + sink Waterproof connector; 2-wire
	NZ2GNS12A2-16DTE	[Input] Single wiring: 12 points; Double wiring: 6 points; 24 V DC; Response time: 1...70 ms; Negative common [Output] Single wiring: 4 points; Double wiring: 2 points; 24 V DC; Source + source Waterproof connector; 2-wire

## ■ CC-Link IE TSN-compatible bridge modules

Product name	Model	Outline
Bridge	NZ2GN-GFB	CC-Link IE TSN-CC-Link IE Field Network bridge module
	NZ2AW1GNAL	CC-Link IE TSN-AnyWireASLINK bridge module

## ■ Advanced information modules

Product name	Model	Outline
Recorder	RD81RC96	Device and label collection
Camera recorder	RD81RC96-CA	Device and label collection, camera image
MES interface	RD81MES96N	Database connection (MX MESInterface-R "SW1DND-RMESIF" is required.)
OPC UA server	RD81OPC96	Embedded OPC UA server (MX OPC UA Module Configurator-R "SW1DND-ROPCUA" is required.)
High-speed data logger	RD81DL96	File server connection (High-speed data logger module tool "SW1DNN-RDLUTL" is required.)* <sup>1</sup>
High-speed data communication	RD81DC96	Program connection (High-speed data communication module tool "SW1DNN-RDCUTL" is required.)* <sup>1</sup>

\*1. For information on how to obtain the software, please contact your local Mitsubishi Electric sales office or representative.

## ■ Energy measuring module

Product name	Model	Outline
Energy measuring	RE81WH	Energy measurement: 1 circuit, data refresh cycle: 10...10000 ms (setting available in 10 ms increments) (A dedicated split-type current sensor is required.)

## ■ Options

Product name	Model	Outline
40-pin connector	A6CON1	Soldering type
	A6CON2	Crimp-contact type
	A6CON3	Insulation-displacement (IDC) type
	A6CON4	Soldering type (cable protrusion: straight or diagonal 45° angle)
Spring-clamp terminal block	Q6TE-18SN	For 18-point screw terminal block type, 0.3...1.5 mm <sup>2</sup> (22...16 AWG)
Connector/terminal block conversion module	A6TBXY36	For positive common input modules and sink/source output modules (standard type)
	A6TBXY54	For positive common input modules and sink/source output modules (2-wire type)
	A6TBX70	For positive common input modules (3-wire type)
Connector/terminal block conversion module cable	AC05TB	For A6TBXY36, A6TBXY54, and A6TBX70 (positive common/sink/source), 0.5 m
	AC10TB	For A6TBXY36, A6TBXY54, and A6TBX70 (positive common/sink/source), 1 m
	AC20TB	For A6TBXY36, A6TBXY54, and A6TBX70 (positive common/sink/source), 2 m
	AC30TB	For A6TBXY36, A6TBXY54, and A6TBX70 (positive common/sink/source), 3 m
	AC50TB	For A6TBXY36, A6TBXY54, and A6TBX70 (positive common/sink/source), 5 m
	AC80TB	For A6TBXY36, A6TBXY54, and A6TBX70 (positive common/sink/source), 8 m* <sup>2</sup>
Relay terminal module	AC100TB	For A6TBXY36, A6TBXY54, and A6TBX70 (positive common/sink/source), 10 m* <sup>2</sup>
	A6TE2-16SRN	For 40-pin connector 24 V DC transistor output modules (sink)
Relay terminal module cable	AC06TE	For A6TE2-16SRN, (sink), 0.6 m
	AC10TE	For A6TE2-16SRN, (sink), 1 m
	AC30TE	For A6TE2-16SRN, (sink), 3 m
	AC50TE	For A6TE2-16SRN, (sink), 5 m
	AC100TE	For A6TE2-16SRN, (sink), 10 m

\*2. Common current 0.5 A or lower

## ■ Software

Product name	Model	Outline
MELSOFT iQ Works	SW2DND-IQWK-E (DVD-ROM edition)	FA engineering software*1 • System management software: MELSOFT Navigator • Programmable controller engineering software: MELSOFT GX Works3*2 (including GX Works2, PX Developer*3) • Motion controller engineering software: MELSOFT MT Works2 • HMI/GOT screen design software: MELSOFT GT Works3 • Robot engineering software: MELSOFT RT ToolBox3**4 • Inverter setup software: MELSOFT FR Configurator2 • Servo setup software: MELSOFT MR Configurator2 • C Controller setting and monitoring tool: MELSOFT CW Configurator
MELSOFT GX Works3	SW1DND-GXW3-E (DVD-ROM edition)	• Programmable controller engineering software (including GX Works2, PX Developer*3)

\*1. For detailed information about supported modules, please refer to the manuals of the relevant software package.

\*2. The MELSOFT GX Works3 menu is switchable between Japanese, English, and simplified Chinese.

\*3. Includes both programming tool and monitor tool for process control.

\*4. RT ToolBox3 mini (simplified version) will be installed if iQ Works product ID is used. When RT ToolBox3 (with simulation function) is required, please purchase RT ToolBox3 product ID.

Product name	Model	Outline
CW Workbench	SW1DND-CWWR-E	Engineering software for C Controller module and C intelligent function module
	SW1DND-CWWR-EZ	Engineering software for C Controller module and C intelligent function module, additional license
	SW1DND-CWWR-EVZ	Engineering software for C Controller module and C intelligent function module, update license
CW-Sim	SW1DND-CWSIMR-EZ	VxWorks® simulation environment for CW Workbench, additional license
	SW1DNC-CWSIMSAR-E	VxWorks® simulation environment for CW Workbench, standalone type
MELSOFT CW Configurator	SW1DND-RCCPU-E	Setting and monitoring tool for C Controller
MELSOFT MX MESInterface-R	SW1DND-RMESIF-E	MES interface function configuration tool
MELSOFT MX OPC UA Module Configurator-R	SW1DND-ROPCUA-E	OPC UA server module configuration tool
MELSOFT PX Developer Monitor tool	SW1DNC-FBDQMON-E	Monitoring tool for process control

"Amazon Web Services," and "AWS" are trademarks of Amazon.com, Inc. or its affiliates in the United States and/or other countries.  
 AnalytiX and its respective modules are registered trademarks of ICONICS, Inc.  
 Android is trademarks of Google LLC.  
 Arm is a registered trademark of Arm Limited (or its subsidiaries) in the US and/or elsewhere.  
 BACnet is a trademark of ASHRAE  
 CANopen and CIA are registered trademarks of CAN in Automation e.V.  
 CFast is a trademark of Compactflash Association.  
 Edgexcross is a registered trademark of the Edgexcross Consortium.  
 EtherNet/IP, DeviceNet, and CIP Safety are trademarks of ODVA, Inc.  
 GENESIS64, Hyper Historian, BridgeWorX, ReportWorX, Energy AnalytiX, Quality AnalytiX, Facility AnalytiX, CFSWorX, IoTWorX, KPIWorX, MobileHMI, WebHMI and their respective modules, Make the Invisible Visible, and ICONICS company logo, are trademarks of ICONICS, Inc.  
 HART® is a registered trademark of FieldComm Group.  
 Intel, Intel Atom, and Intel Core are trademarks of Intel Corporation or its subsidiaries in the U.S. and/or other countries.  
 IOS is a registered trademark or trademark of Cisco Systems, Inc. and/or its affiliates in the United States and certain other countries.  
 Linux is the registered trademark of Linus Torvalds in the United States and other countries.  
 The MariaDB® mark is a trademark of MariaDB Corporation Ab.  
 MATLAB and Simulink are registered trademarks of The MathWorks, Inc.  
 Microsoft, Access, ActiveX, Excel, SQL Server, Visual Basic, Visual C#, Visual Studio, and Windows are registered trademarks of Microsoft Corporation in the United States and other countries.  
 MODBUS is a registered trademark of Schneider Electric USA, Inc.  
 ONVIF is a trademark of Onvif, Inc.  
 OPC UA logo and OPC CERTIFIED logo are registered trademarks of OPC Foundation.  
 Oracle, Java and MySQL are registered trademarks of Oracle Corporation and/or its affiliates.  
 The name PLCopen® is a registered trademark owned by the association PLCopen.  
 PostgreSQL is a registered trademark of the PostgreSQL Community Association of Canada.  
 PROFIBUS and PROFINET are trademarks of PROFIBUS Nutzerorganisation e.V.  
 Python is a registered trademark of the Python Software Foundation ("PSF").  
 QR Code is a trademark or a registered trademark of DENSO WAVE INCORPORATED in JAPAN, the United States and/or other countries.  
 SD/SDHC logo is a trademark of SD-3C, LLC.  
 TimeStorm is a registered trademark of Timesys Corporation.  
 Unicode is a registered trademark of Unicode, Inc. in the United States and other countries.  
 Wind River and VxWorks are trademarks of Wind River Systems, Inc.  
 All other company names and product names used in this document are trademarks or registered trademarks of their respective companies.  
 Trademark symbols such as "™" and "®" might be omitted in this document.

#### Precautions before use

This publication explains the typical features and functions of the products herein and does not provide restrictions or other information related to usage and module combinations. Before using the products, always read the product user manuals. Mitsubishi Electric will not be held liable for damage caused by factors found not to be the cause of Mitsubishi Electric; opportunity loss or lost profits caused by faults in Mitsubishi Electric products; damage, secondary damage, or accident compensation, whether foreseeable or not, caused by special factors; damage to products other than Mitsubishi Electric products; or any other duties.

#### For safe use

- To use the products given in this publication properly, always read the relevant manuals before beginning operation.
- The products have been manufactured as general-purpose parts for general industries, and are not designed or manufactured to be incorporated in a device or system used in purposes related to human life.
- Before using the products for special purposes such as nuclear power, electric power, aerospace, medicine or passenger-carrying vehicles, consult with Mitsubishi Electric.
- The products have been manufactured under strict quality control. However, when installing the products where major accidents or losses could occur if the products fail, install appropriate backup or fail-safe functions in the system.

## Creating Solutions Together.



Low-voltage Power Distribution Products



Transformers, Med-voltage Distribution Products



Power Monitoring and Energy Saving Products



Power (UPS) and Environmental Products



Compact and Modular Controllers



Servos, Motors and Inverters



Visualization: HMIs



Edge Computing Products



Numerical Control (NC)



Collaborative and Industrial Robots



Processing machines: EDM, Lasers



SCADA, analytics and simulation software

Mitsubishi Electric's product lineup, from various controllers and drives to energy-saving devices and processing machines, all help you to automate your world. They are underpinned by software, innovative data monitoring, and modelling systems supported by advanced industrial networking and Edgecross IT/OT connectivity. Together with a worldwide partner ecosystem, Mitsubishi Electric factory automation (FA) has everything to make IoT and Digital Manufacturing a reality.

With a complete portfolio and comprehensive capabilities that combine synergies with diverse business units, Mitsubishi Electric provides a one-stop approach to how companies can tackle the shift to clean energy and energy conservation, carbon neutrality and sustainability, which are now a universal requirement of factories, buildings, and social infrastructure.

We at Mitsubishi Electric FA are your solution partners waiting to work with you as you take a step toward the realization of sustainable manufacturing and society through the application of automation. Let's automate the world together!

# Sales office

MITSUBISHI ELECTRIC Factory Automation Global Website

► Locations Worldwide

[www.MitsubishiElectric.com/fa/about-us/overseas/](http://www.MitsubishiElectric.com/fa/about-us/overseas/)



Mitsubishi Electric's e-F@ctory concept utilizes both FA and IT technologies, to reduce the total cost of development, production and maintenance, with the aim of achieving manufacturing that is a "step ahead of the times". It is supported by the e-F@ctory Alliance Partners covering software, devices, and system integration, creating the optimal e-F@ctory architecture to meet the end users needs and investment plans.



**MITSUBISHI ELECTRIC CORPORATION**  
HEAD OFFICE: TOKYO BLDG., 2-7-3, MARUNOUCHI, CHIYODA-KU, TOKYO 100-8310, JAPAN