

FACTORY AUTOMATION

ICONICS Automation Software Suite



GENESIS64™



Automating the World



Our Factory Automation business is focused on "Automating the World" to make it a better, more sustainable environment supporting manufacturing and society, celebrating diversity and contributing towards an active and fulfilling role.

Mitsubishi Electric is involved in many areas including the following:

Energy and Electric Systems

A wide range of power and electrical products from generators to large-scale displays.

Electronic Devices

A wide portfolio of cutting-edge semiconductor devices for systems and products.

Home Appliance

Dependable consumer products like air conditioners and home entertainment systems.

Information and Communication Systems

Commercial and consumer-centric equipment, products and systems.

Industrial Automation Systems

Maximizing productivity and efficiency with cutting-edge automation technology.



The Mitsubishi Electric Group is actively solving social issues, such as decarbonization and labor shortages, by providing production sites with energy-saving equipment and solutions that utilize automation systems, thereby helping towards a sustainable society.

Product lineup	4
Solutions for every role	8
Operator role.....	10
Engineer role.....	14
Executive role	18
System integrator role	20
Functions	23
Flow of product selection	36
How to count tags	40
License registration procedure	44
Support	45
Operating environment	47
Product list	48

Mitsubishi Electric Visualization products

Flexible HMI solutions that scale to fit your needs

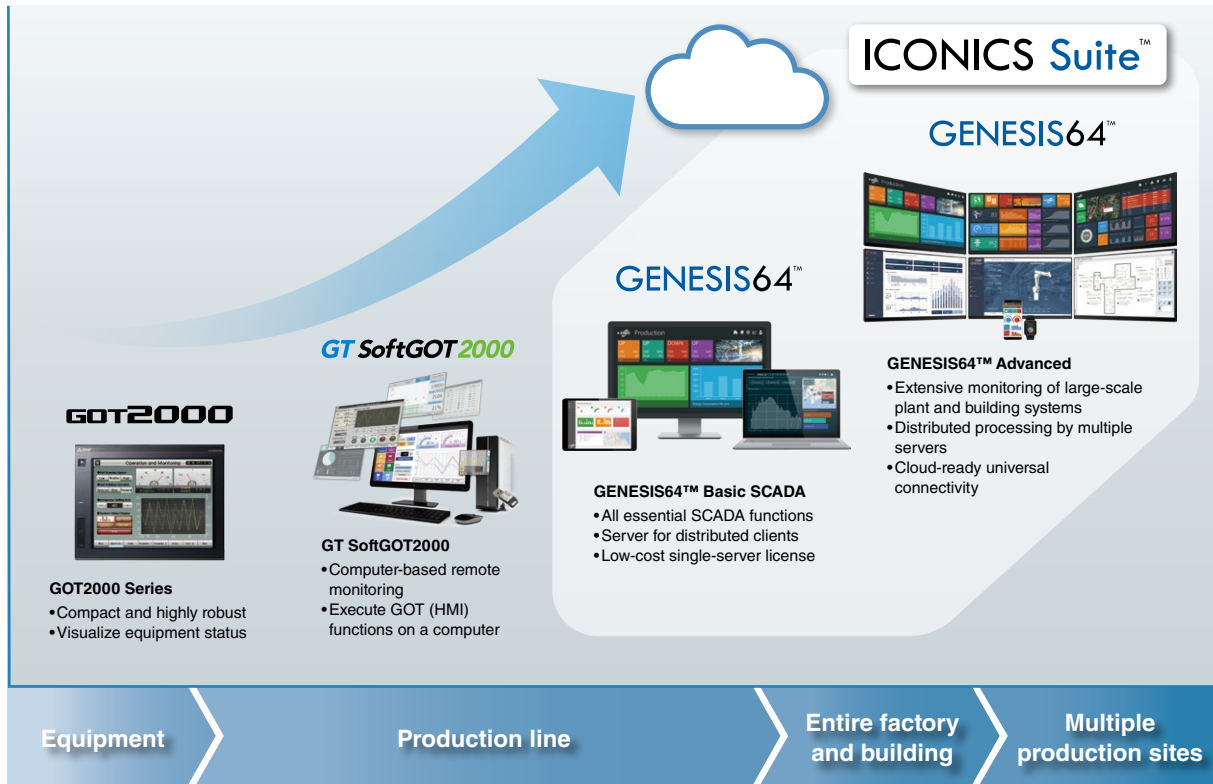

ICONICS Suite™ for integrated monitoring and control

GENESIS64™ is just one in the flexible portfolio of products that is part of the ICONICS Suite™. The scalable software solutions feature advanced visualization technology to run on any desktop or mobile device, high availability, centralized configuration, and ability to connect to a wide variety industry standard communication protocols.

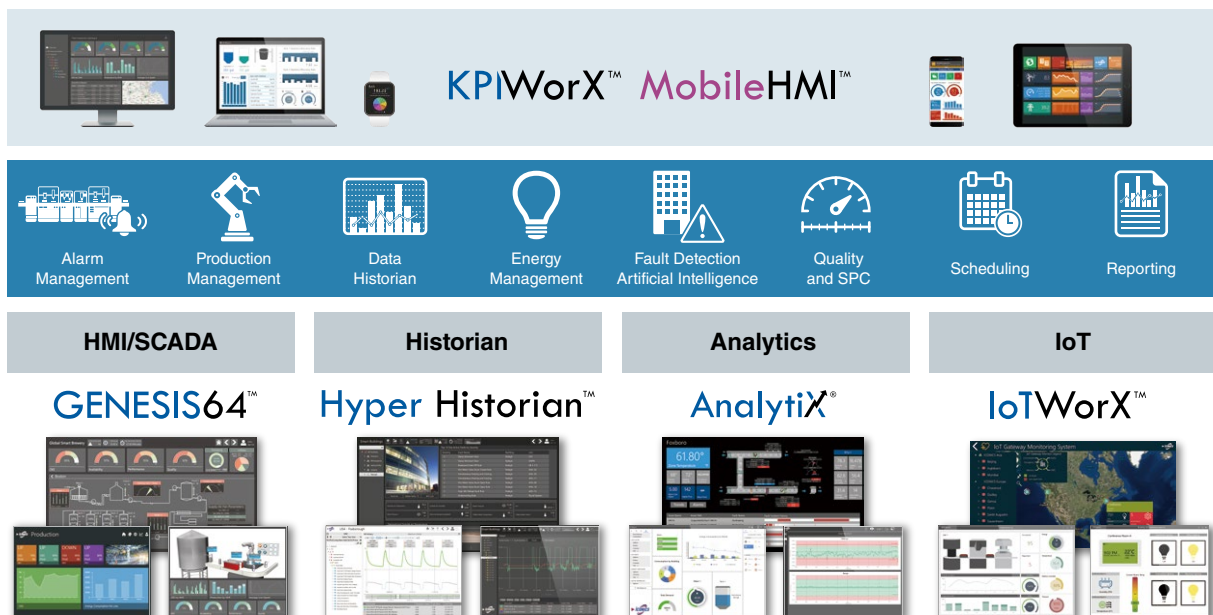

■ GENESIS64™ Basic SCADA Entry-level SCADA package



- Basic SCADA functions
- State-of-the-art, real-time visualization
- ANSI/ISA-18.2 compliant alarm management
- Robust, reliable historical data collection

■ GENESIS64™ Advanced Full-fledged functionality



- Extensive monitoring of enterprise-wide plant and building systems
- Scales to large, distributed systems
- Support for secure cloud communications

ICONICS Suite™ is ideal for any industry

Automotive



Food/beverage



Logistics



Building automation



Water treatment



Oil/natural gas



Data center

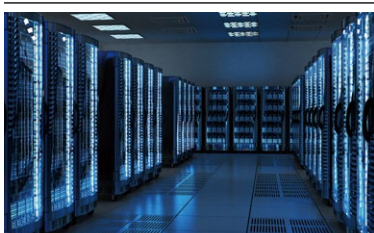

Transportation

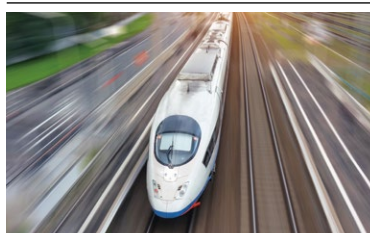

Pharmaceutical



ICONICS Suite™

Make the Invisible Visible™

Real-time insight for operational excellence

This cutting-edge software delivers real-time visualization, mobility, analytics, and connectivity to deliver a contextualized view of enterprise operations for manufacturing, industrial automation, and smart buildings customers.



CONNECT

GENESIS64™ universal connectivity platform supports industry standard open protocol, accelerating integration of all kinds of devices, equipment, and systems, resulting in convergence of IT and OT*1.

*1. OT: Operational Technology

CONTEXTUALIZE

Asset-based organization and navigation facilitates data normalization, comparisons, and situational awareness to get to the root cause quicker through contextualized and actionable information.

VISUALIZE

Secure, real-time visualization on any device is critical to keeping operations running smoothly. GENESIS64™ scales from desktops to browsers, tablets, smartphones, and wearable devices.

DATA UTILIZATION

Improve operational productivity and quality with interactive analytics. Industry applications include OEE*2, SPC*3, energy, and fault detection to provide insight from edge to cloud.

*2. OEE: Overall Equipment Effectiveness
*3. SPC: Statistical Process Control

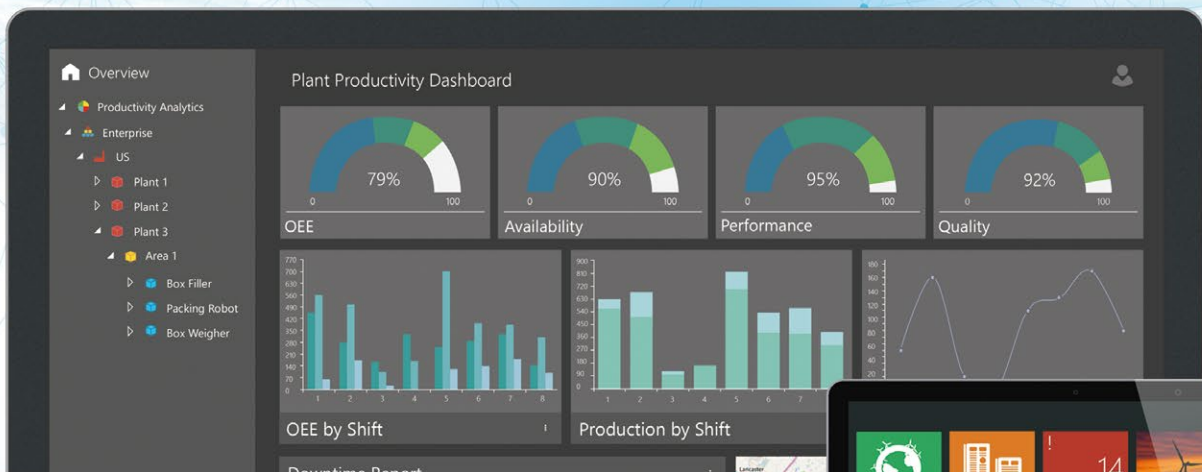

Operator role

Production management

Equipment maintenance



Improve visibility and operational efficiency

▶ P.10

Drive process improvements with actionable information

▶ P.12

Engineer role

Preventive maintenance

Energy saving

Remote monitoring



Identify and address root cause issues

▶ P.14

Configure highly reliable systems

▶ P.17

Executive role

Business improvement

Big data utilization

Remote monitoring



Gain critical insight into your operations with KPIs*¹ and analytics

▶ P.18

Manage global deployments across the enterprise

▶ P.19

*1. KPI: Key Performance Indicator

System integrator role

Easy connectivity and integration

Efficient engineering



Custom solutions to develop value-added services

▶ P.20

Reduce engineering time

▶ P.22

Improve visibility and operational efficiency

Case 01

Production and equipment status need to be monitored to achieve operational excellence

Solution

Leverage universal connectivity to visualize all related information within a fast, responsive, and intuitive graphical environment

- Support for standard Internet browsers and apps on Android™ and Apple® platforms
- Read/write and monitoring capabilities from any device
- Advanced visualization with 2D and 3D models and animations

Visualize production status
GraphWorX™ ▶ Graphic creation/visualization

Display various information on production status and 3D models of monitored targets on one screen

3D model angle can be changed

Production time: 34 %
Total count/Run time: 100 %
Total count/total count: 95 %

Operation Quality Environment Web Manual Movie

OEE Availability x performance x quality: 94.39 %
Current count: 20,950
Target count: 30,000
1/15/2021

Availability Run time/Planned production time: 98.34 %

Performance (Ideal cycle time x total count)/Run time: 98.00 %

Quality Good count/total count: 97.95 %

Automotive assembly line

View screens using a web browser on any mobile device such as computer, tablet, smartphone, and wearable device

WebHMI™/MobileHMI™
▶ Remote monitoring on any smart device

Case 02

Identify errors quickly

Solution

Pinpoint abnormal data patterns and send email notifications. Analyzing the alarm history can quickly identify the root cause

- Alarm list display (intuitive sort and filter function to detect errors)
- Alarm notification by emails
- Check abnormal data shown in AR on a wearable device

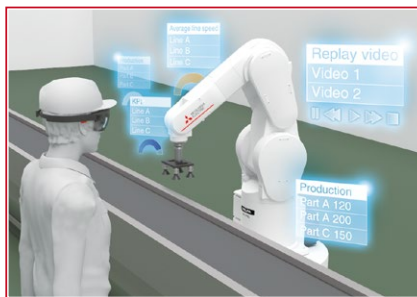

Data related to a faulty device can be checked in AR via a wearable device

WebHMI™/MobileHMI™

► Remote monitoring on any smart device

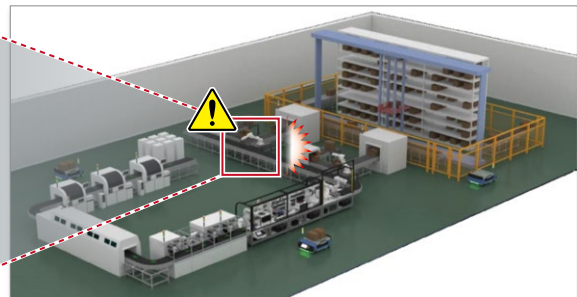

After checking alarm details, a faulty device can be identified on the screen

GraphWorX™ ► Graphic creation/visualization

- Visualize fault causes in order of probability for troubleshooting
- Fault cases can be checked according to priority

Facility AnalytiX® ► Advanced fault detection and diagnostics (FDD) technology **Option**

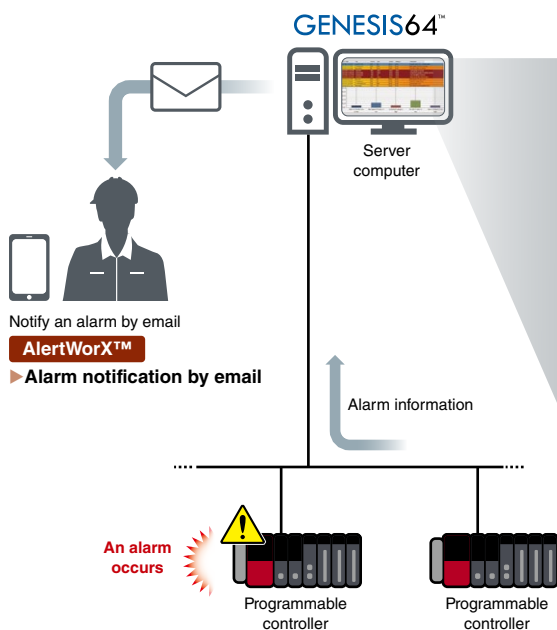

An error occurs

Date / Time	Tag	Priority	Type	Quality	Category	Description
5/23/2013 5:30 PM	Constant Level	1000	LO	Good	Limit	Constant level is low. Possible tank?
5/23/2013 5:31 PM	Pressure	1000	High	Good	Limit	Belt Speed of Pump1 is normal
5/23/2013 7:26 PM	Tank PSI	800	LO/LO	Good	Limit	Level gauge is normal.
5/23/2013 8:08 PM	Level Gauge	750	LO/LO	Good	Limit	Compressor gauge is reading normal
5/23/2013 8:07 PM	Compressor	700	LO	Good	Limit	Core Humidity is normal.
5/23/2013 8:18 PM	Humidity	850	LO/LO	Good	Limit	Valve 3 on the Box Line is slow
5/23/2013 8:22 PM	Pressure	1000	High	Good	Limit	
5/23/2013 8:58 PM	Pressure	1000	High	Good	Limit	The PSI in Tank1 is low
5/23/2013 8:00 PM	Temperature	1000	High	Good	Limit	Level gauge is low.
5/23/2013 6:11 PM	Belt Speed	1000	High	Good	Limit	Alarm Torque is at acceptable level.

- Visualize the alarm information list with eye-catching colors
- Quickly confirm an error

AlertWorX™ ► Alarm visualization

Drive process improvements with actionable information

Case 03

Get access to relevant information when and where it is needed

Solution

Prompt troubleshooting of equipment with various functions such as related manual display and remote instruction utilizing AR

- Remote instructions via voice and images
- Access equipment manuals in conjunction with error details
- Check troubleshooting instructions on a wearable device in real-time

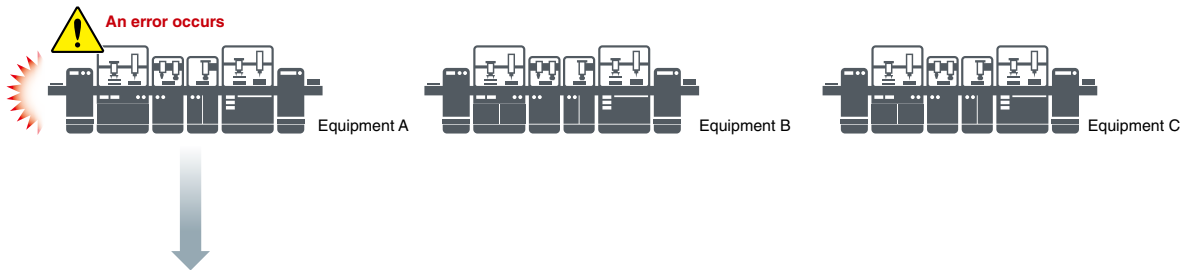

Example 1

Access manuals to identify equipment error codes. A field service worker can quickly check the manual on a computer, tablet, or smartphone.

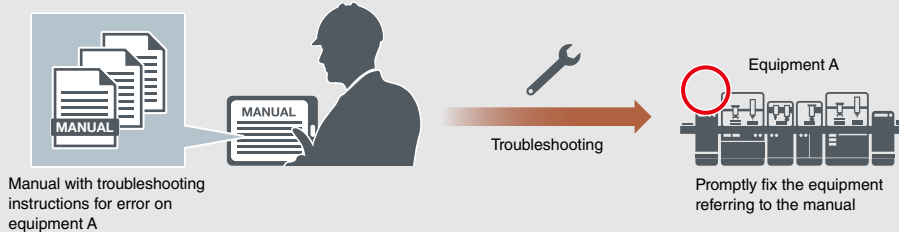

Example 2

A product expert can provide instructions on his tablet or any other mobile device by directly writing on the screen. A field service worker can troubleshoot equipment by checking instructions of AR display on a wearable device.

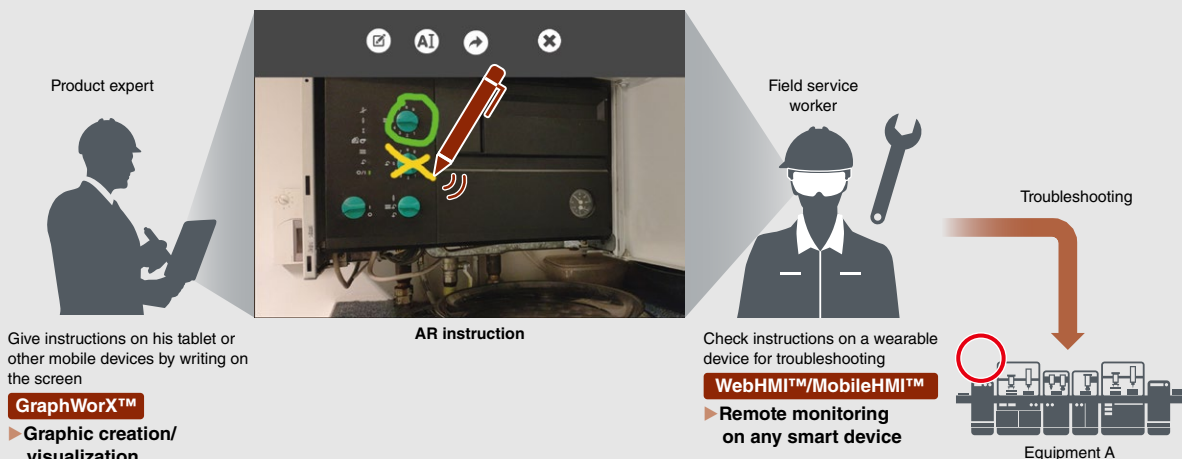

Case 04

Require prompt troubleshooting support when equipment fails

Solution

Upon equipment downtime, assign the field service worker closest to the target factory using built-in location services*1

- Detect facility and equipment errors and manage alarm information
- Provide push notifications to field service worker's mobile phones for quick response times and fast troubleshooting



Visualize information from factory B The status of target equipment can be identified through alarm information and trend graphs

Alarm information

Time / Date	Tag	Priority	Type	Quality	Category	Description
5/23/2013 7:30 PM	CoastLevel	100	LO	Good	Limit	Coast level is low. Possible leak?
5/23/2013 8:33 PM	~Pressure	100	HI	Good	Limit	Belt Speed of Pump1 is normal
5/23/2013 7:26 PM	Tank PSI	800	LOLO	Good	Limit	Level gauge is normal.
5/23/2013 6:08 PM	Level Gauge	700	LOLO	Good	Limit	Compressor gauge is reading normal
5/23/2013 6:37 PM	Compressor	300	LO	Good	Limit	Core humidity is normal.
5/23/2013 6:18 PM	Humidity	850	LOLO	Good	Limit	Belt 1 on the Box Line is slow.
5/23/2013 6:58 PM	~Pressure	100	LO	Good	Limit	The PSI in Tank1 is low.
5/23/2013 6:00 PM	~Temperature	100	HIHI	Good	Limit	Level gauge is low.
5/23/2013 6:11 PM	Belt Speed	100	LO	Good	Limit	Aux Torque is at acceptable level.

Alarm visualization

Trend graph

Real-time and historical trends

Check field service location from a remote location

CFSWorX™ ▶ Monitoring of field service workers and maintenance personnel **Option**

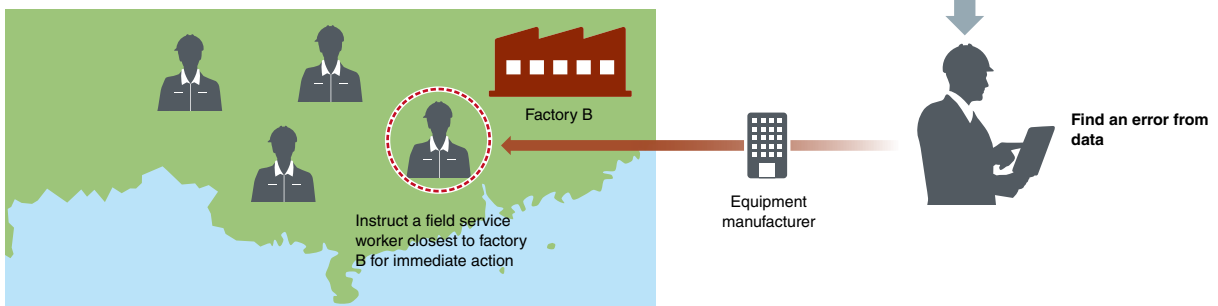

*1. GENESIS64™ provides a monitoring of field service workers and maintenance personnel function. However, Mitsubishi Electric does not provide maintenance service utilizing this function.

Identify and address root cause issues

Case 05

Improve productivity through IT and OT integration

Solution

Integrate with enterprise systems to improve productivity through unified monitoring, control and analysis of production data

- Analyze system data through integrated IT and OT systems
- Transform production data into actionable information

GENESIS64™



System connection

GridWorXTM
Database access



MES

ERP

Breakdown of total count

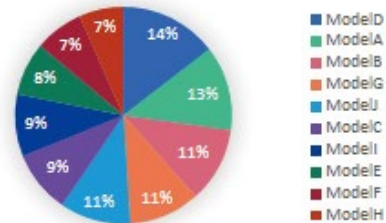
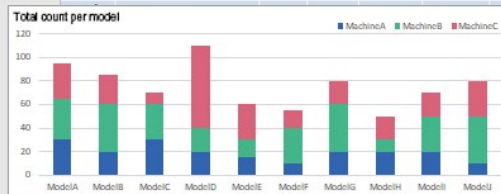

Image	Item	Planned count	Actual volume	Inventory turnover	Stock	Throughput	Quality	Lead time
	Model A	1,000	530	69%	40	120	98%	5.6
	Model B	1,500	1,050	90%	300	150	95%	4.8
						100	99%	3.4
						1,000	97%	9.0
						80	100%	12.5



Visualize production information as a graph and table



Turn data into information to improve production and equipment performance



Production line

Case 06

Optimize system operation by analyzing accumulated data

Solution

Various analysis functions using historical data help identify energy offenders and allow for quick troubleshooting

- Preventive maintenance by analyzing equipment operational status
- Visualization and analysis of energy consumption realizes energy saving
- Improve product quality by visualizing process control limits

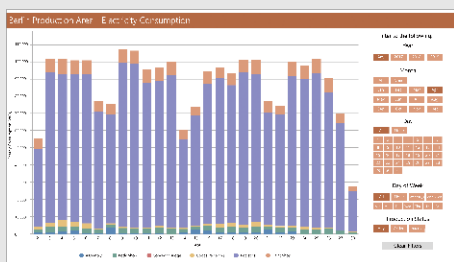

Energy consumption charts identifying saving opportunities

Energy AnalytiX®

- Visualization and analysis of energy consumption

Option

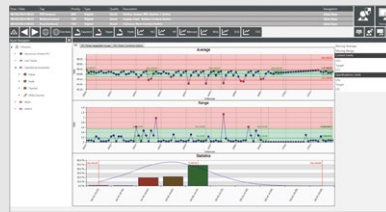

Quality management of production line using control chart

Quality AnalytiX®

- Quality control

Option

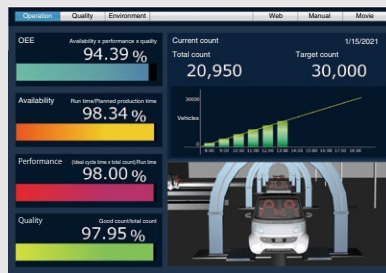

Visualize equipment operational status on one screen

GraphWorX™

- Graphic creation/ visualization

Analyze collected data



Get actionable information for preventive maintenance from the analysis results

GENESIS64™



Data collection (database accumulation)

Hyper Historian™

- High-speed/highly reliable data collection

Option

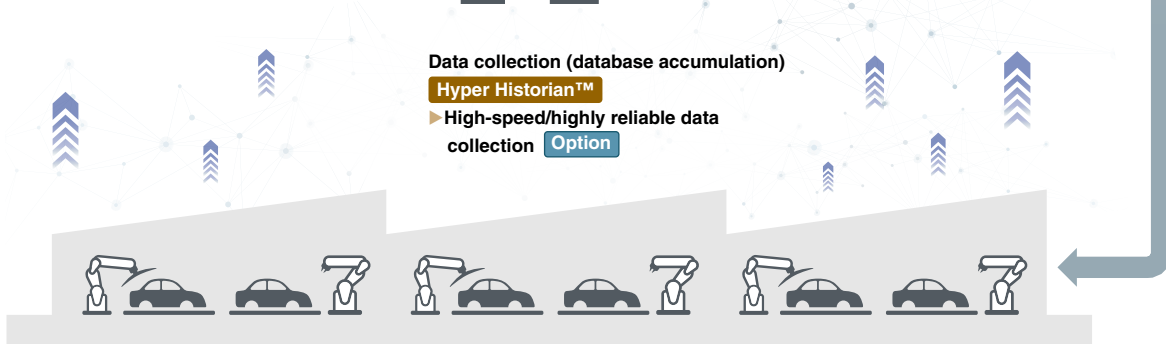

Production line

Case 07

Multi-site production management

Quickly compare the performance of multiple sites through real-time visualization of geographically disparate systems

Solution

- Unified production site data management
- Realize standardized operations through monitoring and management of multiple assets
- GOT (HMI) screens created for equipment can be utilized, enabling integrated screens creation easier

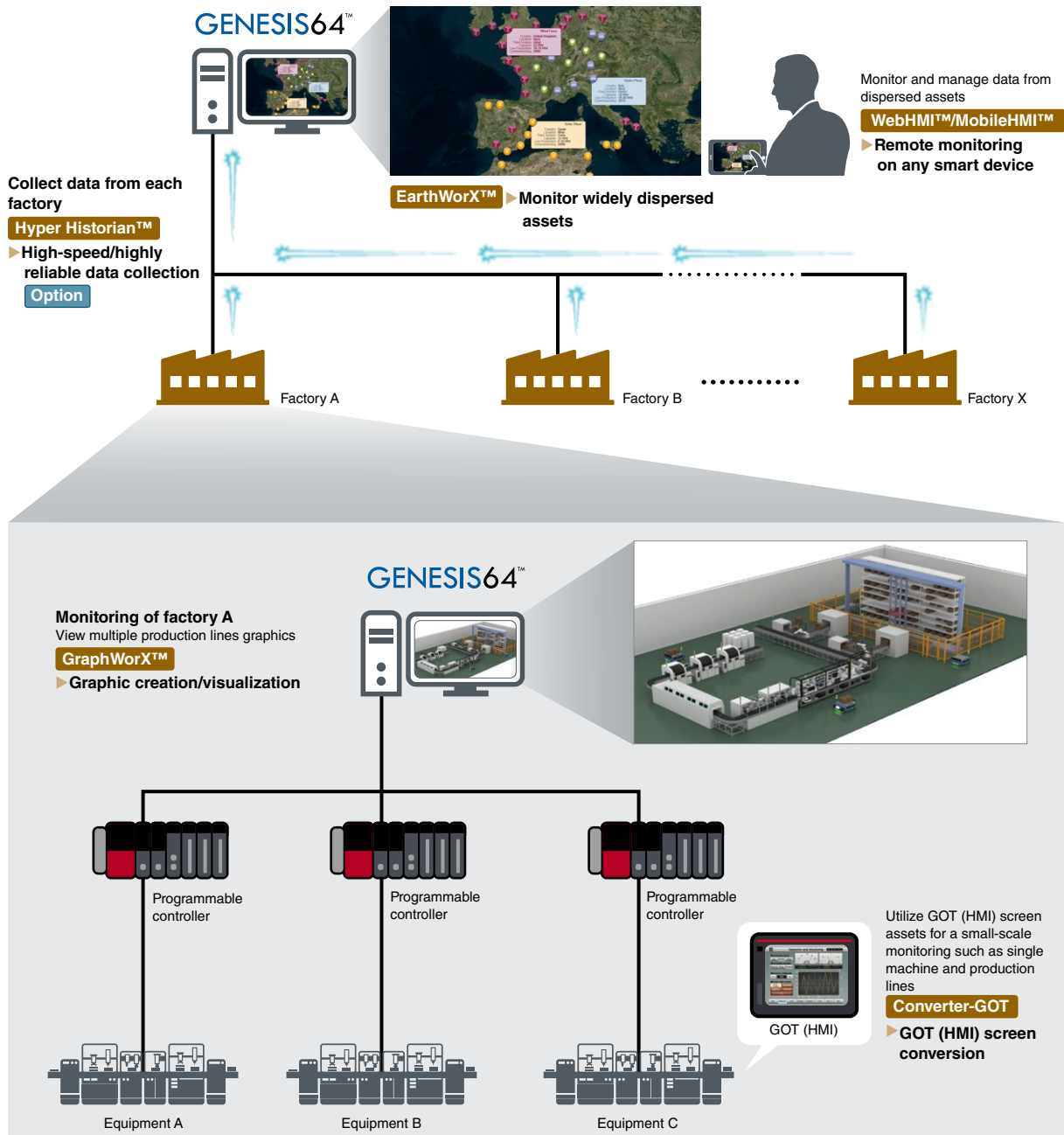

Configure highly reliable systems

Case 08

Ensure system uptime through high availability deployment options

Solution

Provide stable operations by applying mission critical system architectures

- Redundant servers ensure continuous operation even when an error occurs
- Prevent overload of servers with distributed processing by multiple servers

Redundant server configuration

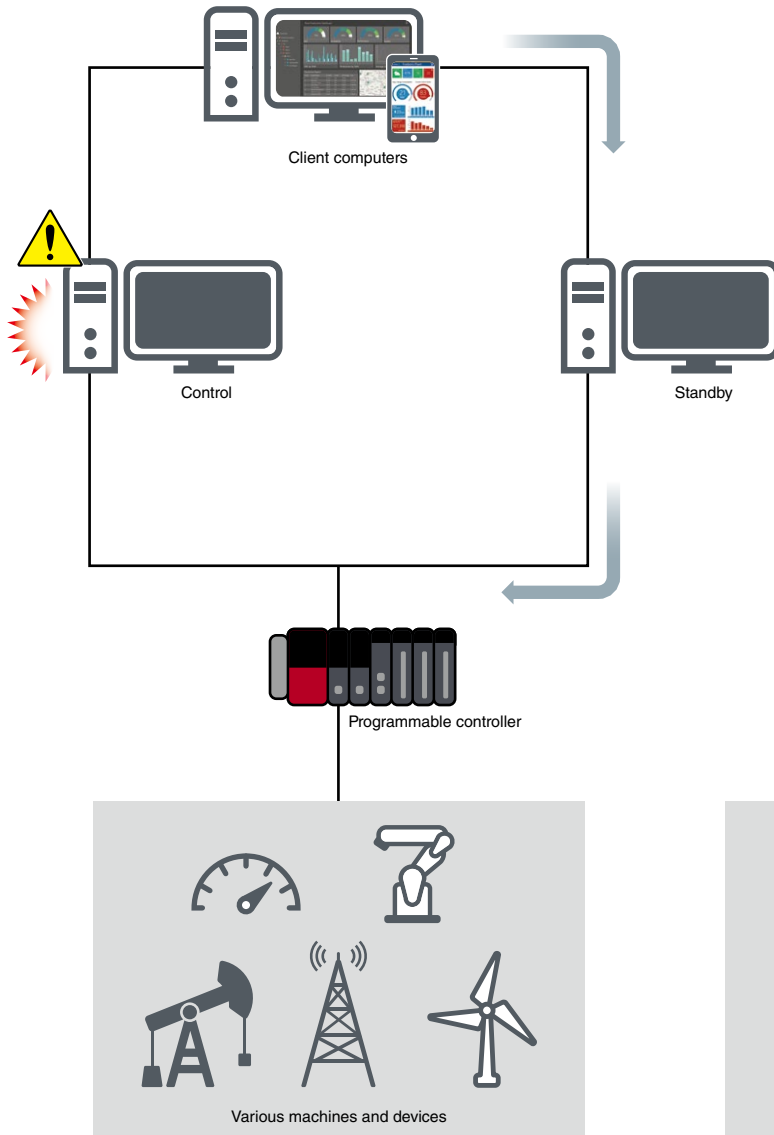

Distributed server configuration

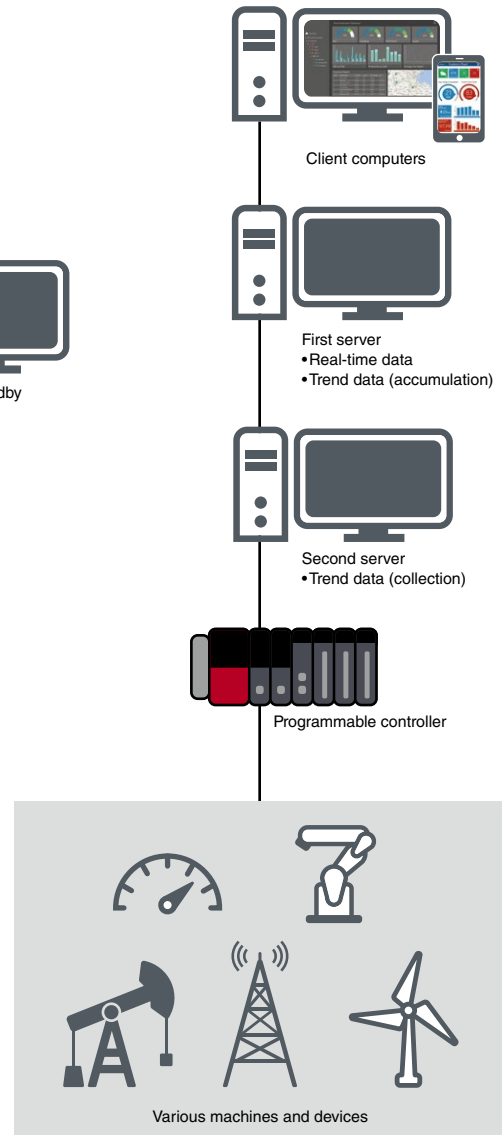

Operator role

Engineer role

Executive role

System Integrator role

Functions

Gain critical insight into your operations with KPIs and analytics

Case 09

Turn large amounts of data into actionable information to improve business operations

Solution

Extract large volumes of data and visualize in easy self-service dashboards

- High-speed and large capacity data collection
- Create templates by combining various graphical objects and data styles
- Create self-service dashboards (drag and drop) on any mobile device

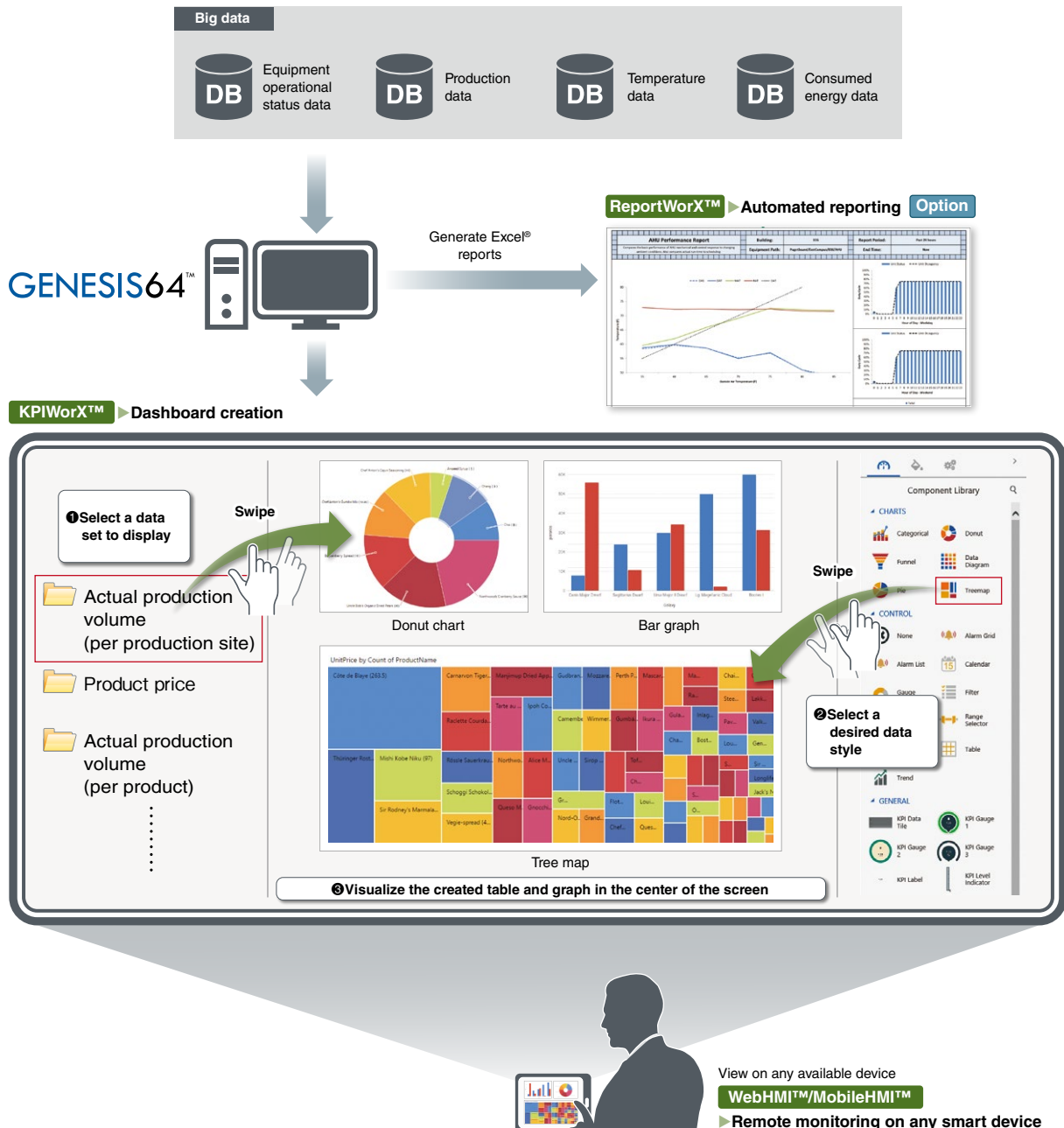

Manage global deployments across the enterprise

Case 10

Monitor sites worldwide in real-time to shorten improvement cycles

Solution

Integrate and collect data from widely dispersed assets in the cloud

- Utilize the cloud for secure data collection and system monitoring
- Unified management of data from different production sites
- Remote monitoring and control via web browsers and mobile applications

Centrally manage all production sites data in one server

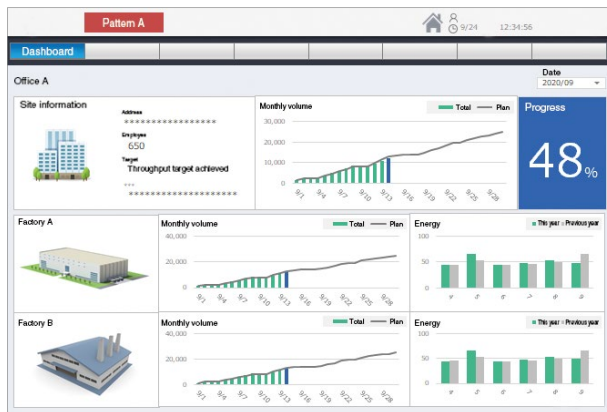

GraphWorX™

► **Graphic creation/visualization**



Executive

Check the monitoring screen on a web browser and mobile application

WebHMI™/MobileHMI™

► **Remote monitoring on any smart device**

Send feedback about insights from the data to the field

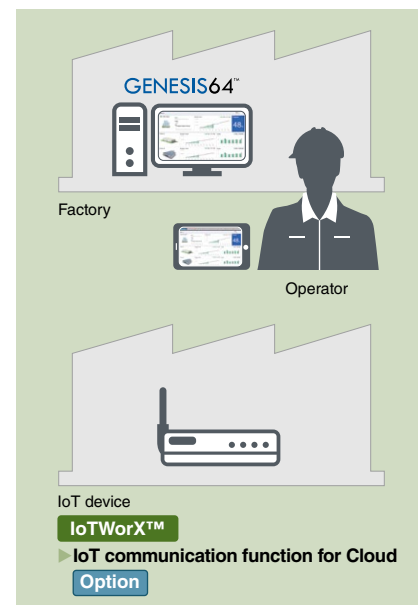

Operator role

Engineer role

Executive role

System integrator role

Functions

Custom solutions to develop value-added services

Case 11

Connect with a wide variety of devices and systems

Enhanced connectivity enables communication with various devices, secure information exchange, and integration with third-party systems

Solution

- Support popular open protocols such as OPC™, BACnet®, and MODBUS®
- Deliver shop floor data to MES, ERP, and work order management systems
- Flexible system configuration by managing device data in a hierarchical tree structure
- Enable enterprise data monitoring and control via the cloud

Flexibly support system change by managing device data in a hierarchical tree structure

AssetWorX™

▶ Asset management using a hierarchical tree structure



Easily monitor disparate assets via secure cloud communications



IoT device

IoTWorX™

▶ IoT communication function for Cloud **Option**

GENESIS64™



System connection

GridWorX™

▶ Database access

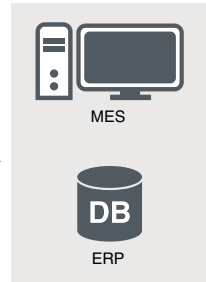

OPC server

BACnet® MODBUS®



Lighting controller

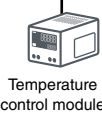

Temperature control module

OPC™

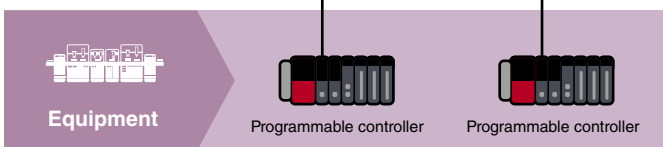
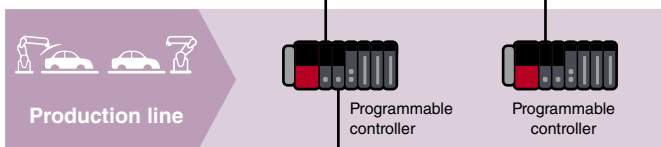
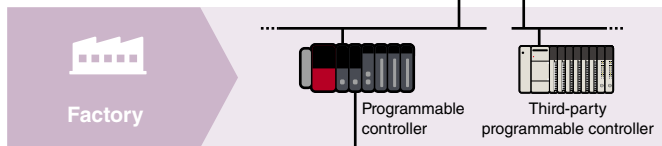

Case 12

Coordination with the process system such as lighting/air conditioning and power monitoring

Solution

Easily generate communication settings and monitoring screens for the process system

- Utilizing process programs created with GX Works3, generating communication settings and monitoring screen for the process system is easier, reducing system configuration time
- Display the faceplate list from the control panel screen
- Adjust equipment status by opening a tuning screen from the faceplate

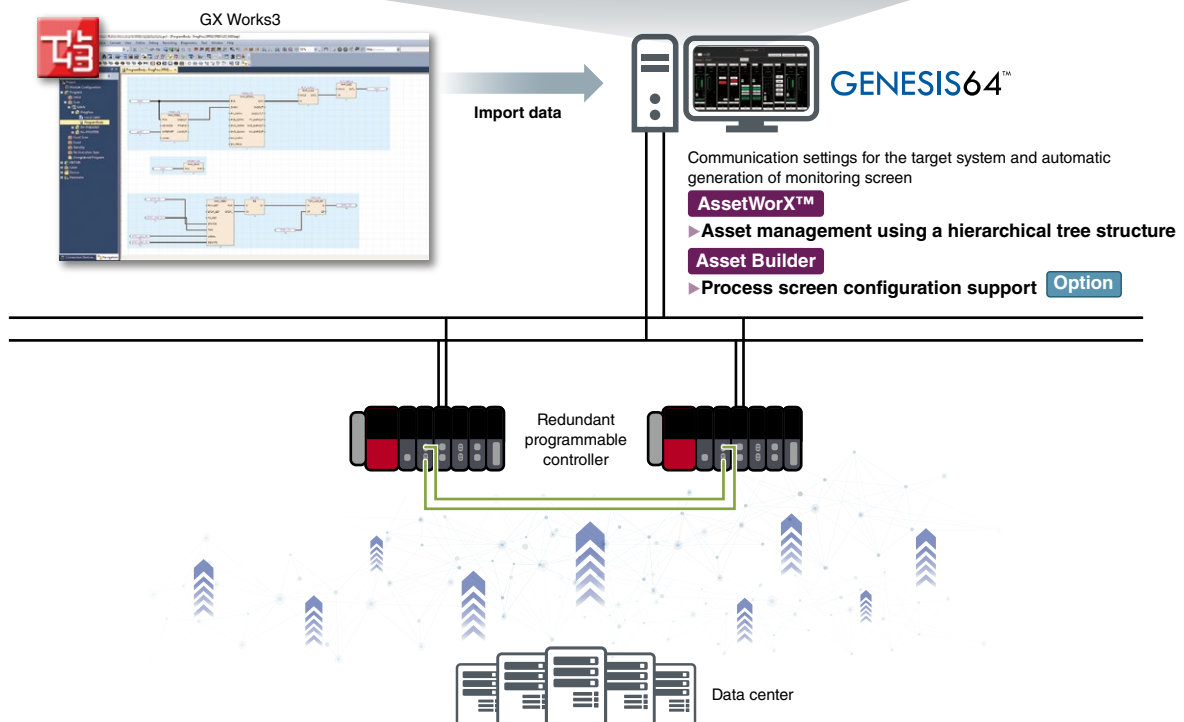
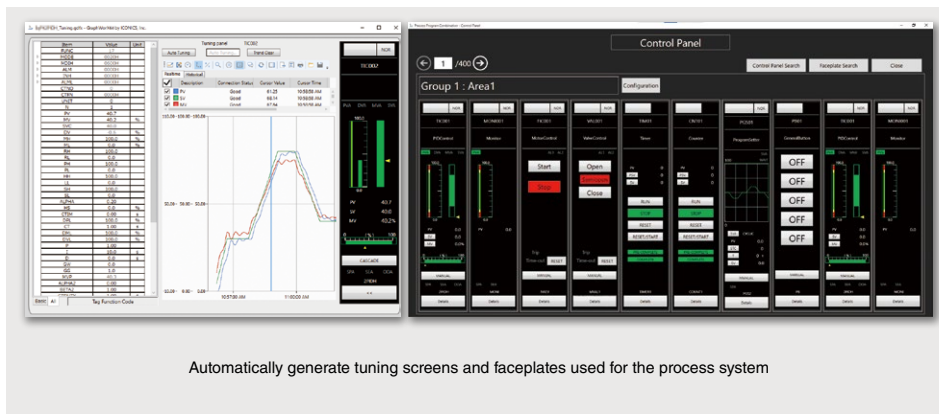

Operator role

Engineer role

Executive role

System Integrator role

Functions

Reduce engineering time

Case 13

Efficiently develop systems that solve complex customer needs

Solution

Boost software scalability and rapidly deliver innovative capabilities with time-saving development tools

- Reduce display creation time by importing CAD drawings of graphical assets
- Develop reusable equipment and asset templates to rapidly deploy across your enterprise
- Exchange information with external databases using powerful workflow technology
- Simplify screen development using point-and-click tools; no scripting required



Easily create intuitive operator displays
User-friendly screens in high-definition can be created with 2D and 3D graphics and various symbols
GraphWorX™ ▶ Graphic creation/visualization



Monitor operating status
Visualize data collected at high speed in charts, trends, or reports to easily identify patterns or abnormalities
TrendWorX™ ▶ Real-time and historical trends
ReportWorX™ ▶ Automated reporting **Option**

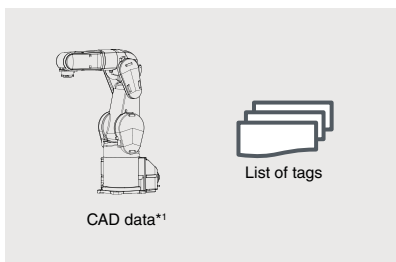

GENESIS64™

Quickly configure alarms, historical data logging, assets, and more from any workstation
Workbench
▶ Centralized project management

Create monitoring displays with dynamic properties, animations, and flexible aliasing
GraphWorX™
▶ Graphic creation/visualization

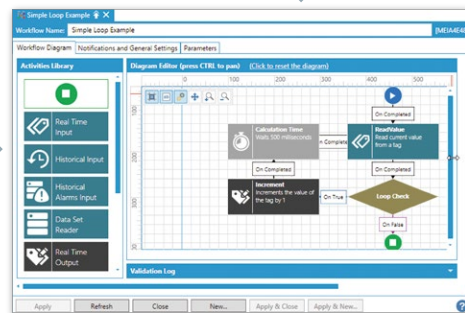
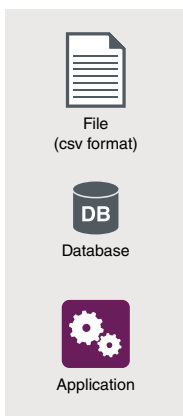

Customized applications can be executed (or read/write) through Workflow from GENESIS64™
Workflow ▶ Programming by flowchart



Remotely monitor and control
Remote monitoring function enables access from mobile devices such as smartphones and tablets (voice command control is also supported)
WebHMI™/MobileHMI™
▶ Remote monitoring on any smart device

*1. Following CAD formats are supported.
3D format: XAML (.xaml), COLLADA™ (.dae), 3D Studio (.3ds), Wavefront (.obj), Autodesk® (.dwg/.dxf), Green Building XML (.gbXML)
2D format: XAML (.xaml), Windows® Metafiles (.wmf/.emf), Scalable Vector Graphics (.svg), Autodesk® (.dwg/.dxf)

GraphWorX™

■ Graphic creation/visualization

Stunning and user-friendly graphics can be created at a low cost using provided 2D, 3D*1 symbols and CAD data. Various displays according to applications are available, such as automatically changing displayed information according to magnification and reduction percentage and showing the entire system realistically using 3D models*1.

*1. GENESIS64™ Basic SCADA does not support 3D.

▶ Graphic creation

Easily create graphics using various symbols, figures, and viewers provided and customer's CAD data.

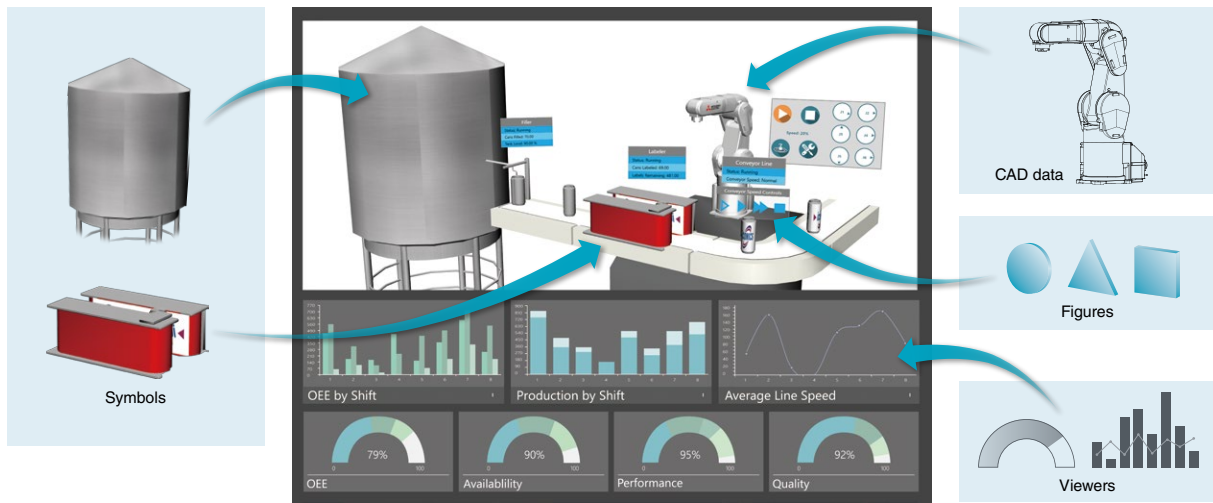

▶ Graphic visualization

Angle change and zooming of created graphics are possible. In addition, color can be added to visualize the status intuitively.

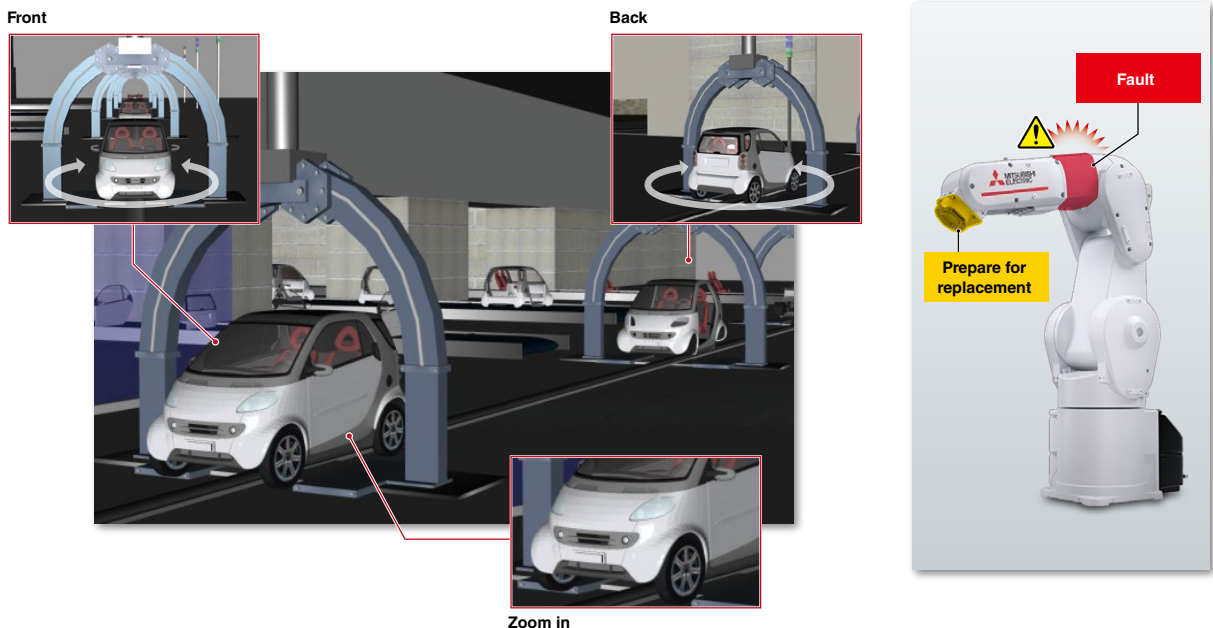

Operator role

Engineer role

Executive role

System Integrator role

Functions

TrendWorX™

Real-time and historical trends

Visualize enterprise-wide data in trends, logs, charts, and reports with TrendWorX™. Chart real-time and historical data from any database to provide users with actionable data. Customize replay rates, colors, axis scales, and multiple cursors. Interact with trends during operation with multiple playback and filtering functions.



Data can be color-coded as a heat map*1 to make data easily visible, allowing quick analysis.

*1. Days and times when alarms most frequently occur and such can be easily understood by colors that change based on threshold values.

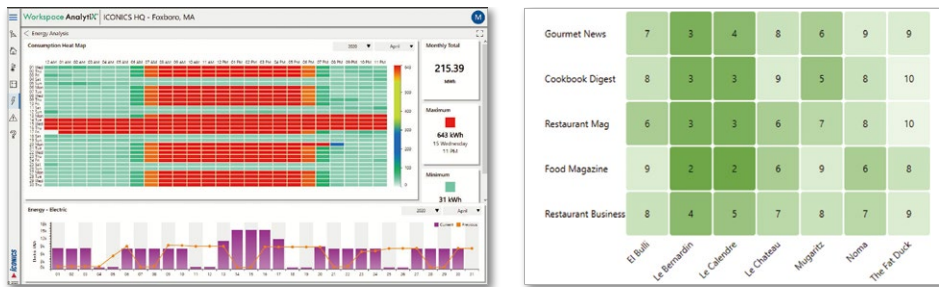

AlarmWorX™/AlertWorX™

Alarm visualization/notification

Notify your personnel of abnormal conditions and events in real time with ANSI/ISA-18.2 compliant features. Integrate the AlarmWorX™ Viewer into any SCADA or HMI display to bring to light real-time and historical alarms when and where operators need to see them.

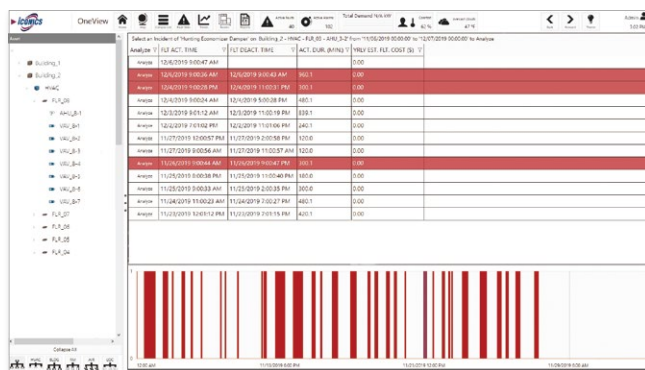

	Present	Active	Acked
area A	43	10	2
factory A	3	0	0
factory B	0	0	0
factory C	1	0	0
factory D	1	0	0
factory E	11	2	1
factory F	5	0	0
factory G	10	7	0
factory line A	3	1	0

Visualize alarms according to the equipment and factory line configuration created with AssetWorX™

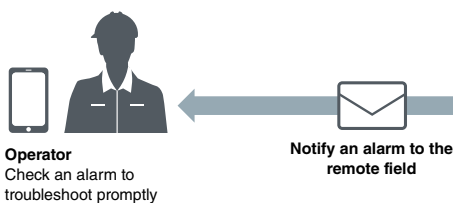

WebHMI™/MobileHMI™

■ Remote monitoring on any smart device

Bring SCADA visualization to any device. Create displays on the desktop that can responsively scale to run on any mobile client. Leverage native apps to provide a consistent user experience on any smartphone, tablet, or HTML5 compliant web browser*1. GENESIS64™ responsive UI technology flawlessly transitions between clients to provide a consistent user experience*2.

*1. Please refer to the operating environment on page 47 for supported web browsers.

*2. Please refer to "2. Select client products" on page 38 flow of product selection for details.

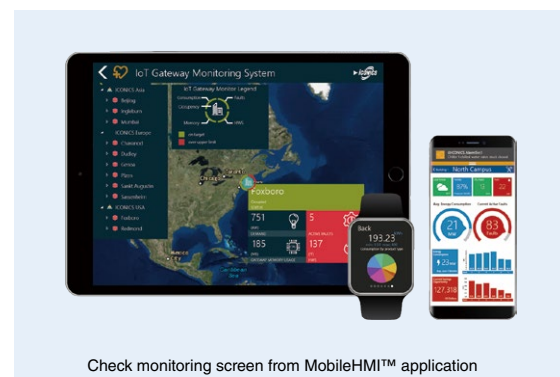
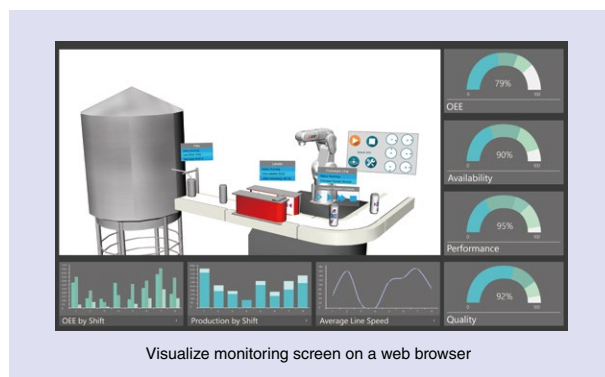

Intuitive operation is possible on a tablet and smartphone



EarthWorX™

■ Monitor widely dispersed assets

EarthWorX™, a geographic information system (GIS) mapping module, provides visualization for widely dispersed assets. Create a geographical overview to monitor multiple locations while maintaining the ability to locate and drill into specific assets. Smart Pin™ enables the status of many assets to be easily understood at a glance. Users can integrate with Google Maps™, Bing® Maps, and Esri™ to include additional GIS mapping features and data layers.

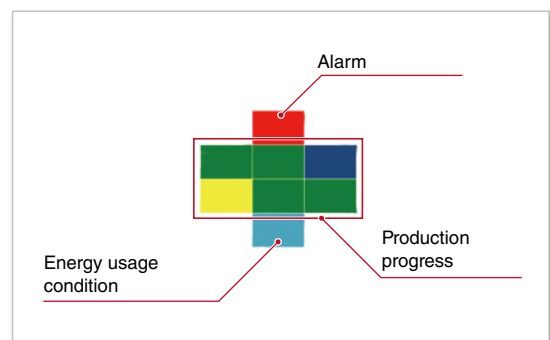
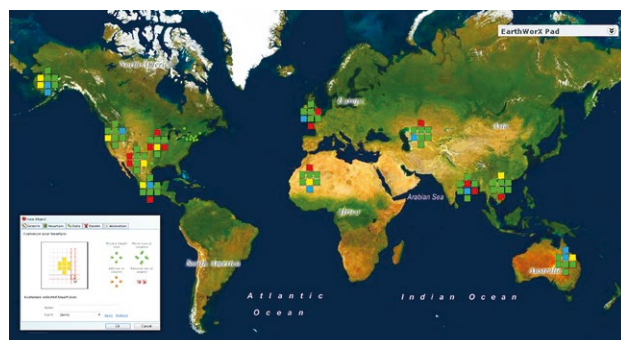

Operator role

Engineer role

Executive role

System integrator role

Functions

AssetWorX™

■ Asset management using a hierarchical tree structure

AssetWorX™ is an international standard ANSI/ISA-95*1 compliant asset management module. Map the physical world to its digital twin according to the actual structure of the enterprise, company, process, factory, line, etc. Assets can be organized and configured in the Workbench, optionally including alarms, customizable colors, icons, and drag-and-drop functionalities. The runtime component provides intuitive navigation and is perfectly suited for scaling large projects, which can be easily achieved using the Excel® based bulk asset configuration.

*1. International standard which defines equipment hierarchy models for physical assets in manufacturing.

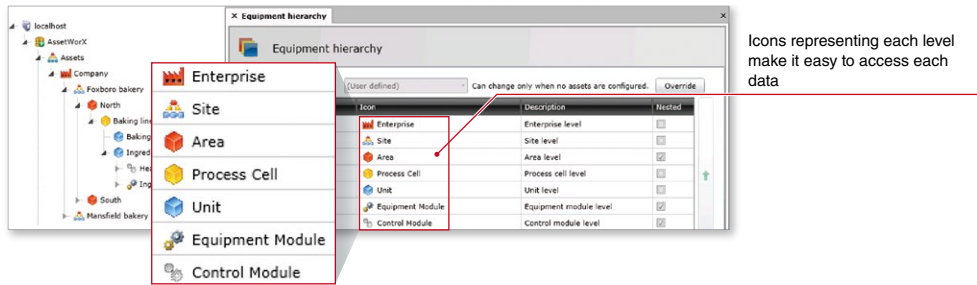

Icons representing each level make it easy to access each data

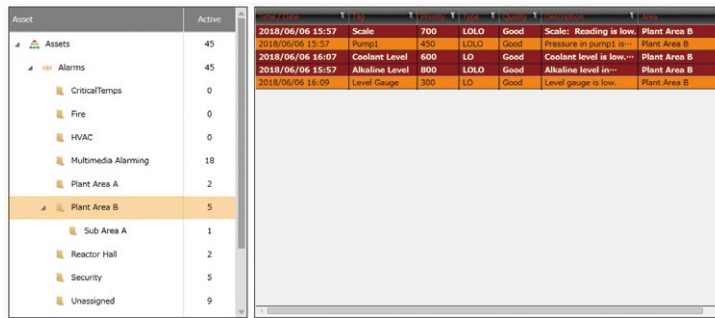

AssetWorX™ further enhances visualization of alarms and trends on each level when combined with other functions such as AlarmWorX™ and TrendWorX™

GridWorX™

■ Database access

GridWorX™ processes values retrieved from third-party databases such as Microsoft® SQL Server®, Oracle®, and ODBC, and displays values as tables and charts. Easily integrate with MES, ERP, work order systems, and other business applications, enabling detection and early identification of system issues.

- Microsoft® SQL Server®
- Oracle®
- ODBC



Visualize

No.	Product name	Production site	Starting date	Updated date	Cumulative sum
1	Product A	Area A	20/03/25	20/05/06	102
2	Product B	Area B	20/01/15	20/07/14	100
3	Product C	Area C	20/10/30	20/01/23	305
4	Product D	Area D	20/02/22	20/09/06	256
5	Product E	Area E	20/04/10	20/02/14	463
6	Product F	Area F	20/06/05	20/11/23	110

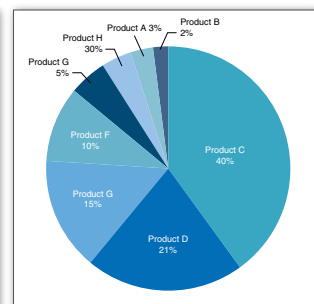
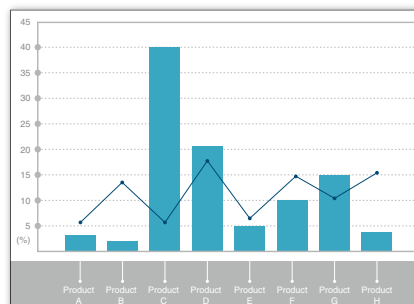

KPIWorX™

■ Dashboard creation

KPIWorX™ is an application for delivering self-service executive dashboards to any desktop or mobile device, utilizing preconfigured widgets and symbols such as meters, alarms, trends, and charts for business intelligence. Get timely KPI and OEE information on any smartphone or tablet computer, or on your wrist with Apple Watch® support. Executives can quickly view insightful charts and analytics information for more proactive decision making.

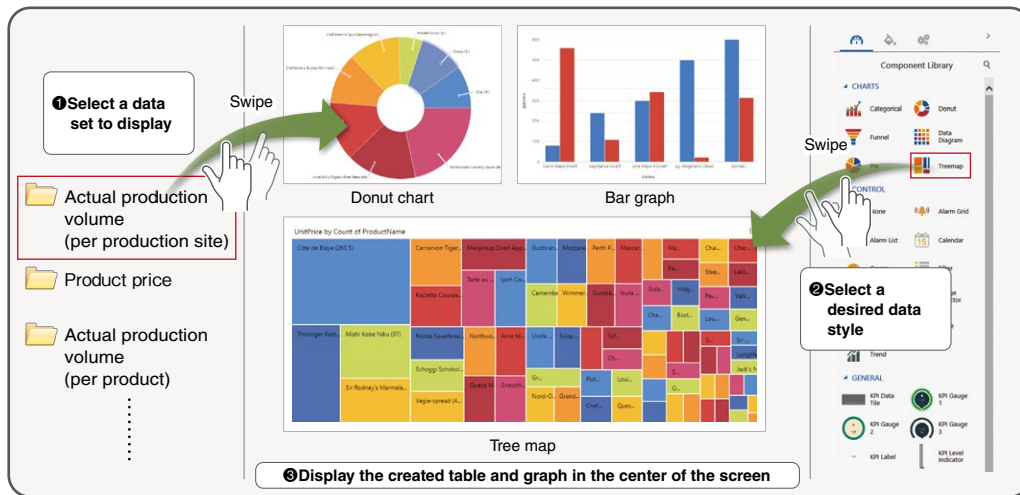

Hyper Historian™*1 Option

■ High-speed/highly reliable data collection

Hyper Historian™ is a high-speed*2, reliable, and robust historian. Designed for the most demanding applications with support for redundancy and distributed data collection, Hyper Historian™'s advanced high compression algorithm delivers unparalleled performance with efficient use of resources. It integrates with the latest big data technologies, including Azure® SQL, Azure® Data Lake, Apache Kafka®, and Apache Hadoop®. This makes Hyper Historian™ the most efficient and secure real-time plant historian for the latest Microsoft® operating systems.

*1. Hyper Historian™ Express (simplified ver.) is included in GENESIS64™. Please refer to the function list (Hyper Historian™ product) on page 38 for details.
 *2. The speed depends on the system configuration.

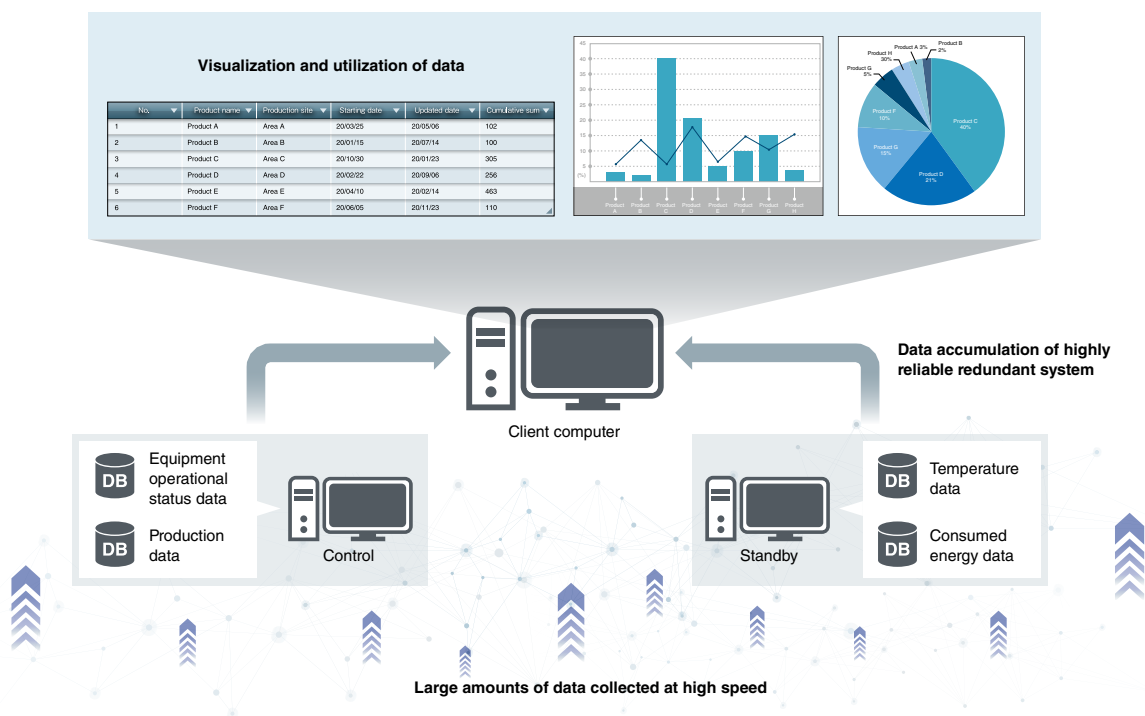

Operator role

Engineer role

Executive role

System integrator role

Functions

Workflow

■ Programming by flowchart

Workflow is continuous processing based on data such as real-time or historical data values, alarm notifications, faults, and more. It can be graphically configured and executed using a flowchart built from a library of highly-customizable activities.

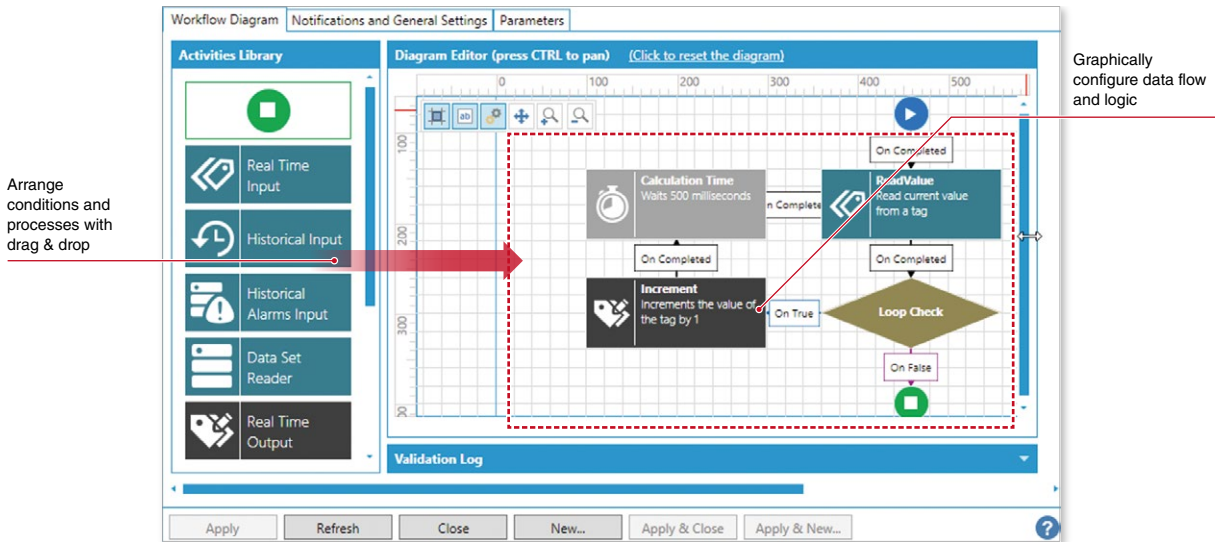

BridgeWorX™*1

■ Transaction-based processing by flowchart

BridgeWorX™ enables configuration and execution of transactions built on the powerful Workflow engine. Graphical data bridging enables users to rapidly implement data orchestration and integration tasks that adhere to business logic without requiring programming. BridgeWorX™ can access Microsoft® SQL Server®, Oracle®, Microsoft® Access®, SAP®, and virtually any real-time or archived manufacturing or business data source.

*1. GENESIS64™ includes LITE (5 transactions). Please refer to the function list (server product) on page 37 for details.

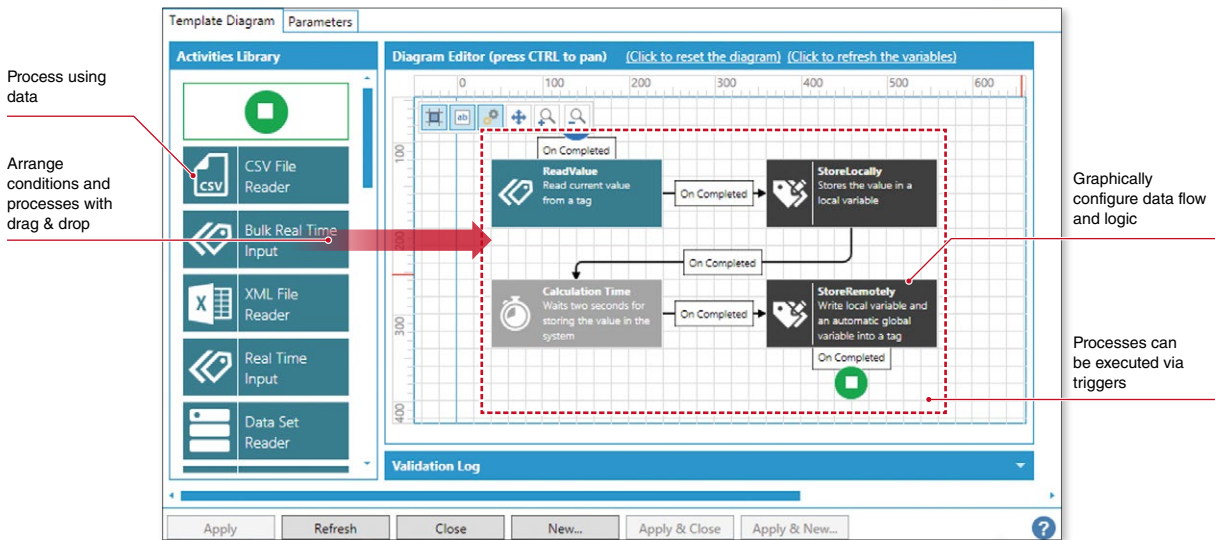

Comparison between Workflow and BridgeWorX™

	Workflow	BridgeWorX™
Processable data	Data on GENESIS64™	Data on GENESIS64™ Data/file/web service
Execution format	Cycle	Cycle, trigger

ReportWorX™*1 Option

■ Automated reporting

ReportWorX™ is a powerful reporting tool that turns volumes of data into manufacturing intelligence. Create reports in Excel®, HTML, or PDF format with data from the plant floor, corporate databases, and everywhere in between.*2 Its advanced scheduling engine delivers reports automatically via the web, from an HMI screen, or based on user-specified criteria. Scheduling options include daily, weekly, monthly, and yearly, or based on a variety of triggers.

*1. ReportWorX™ Express (simplified ver.) is included in GENESIS64™. Please refer to the function list (A server product) on page 37 for details.
 *2. Original templates are created in Excel®.

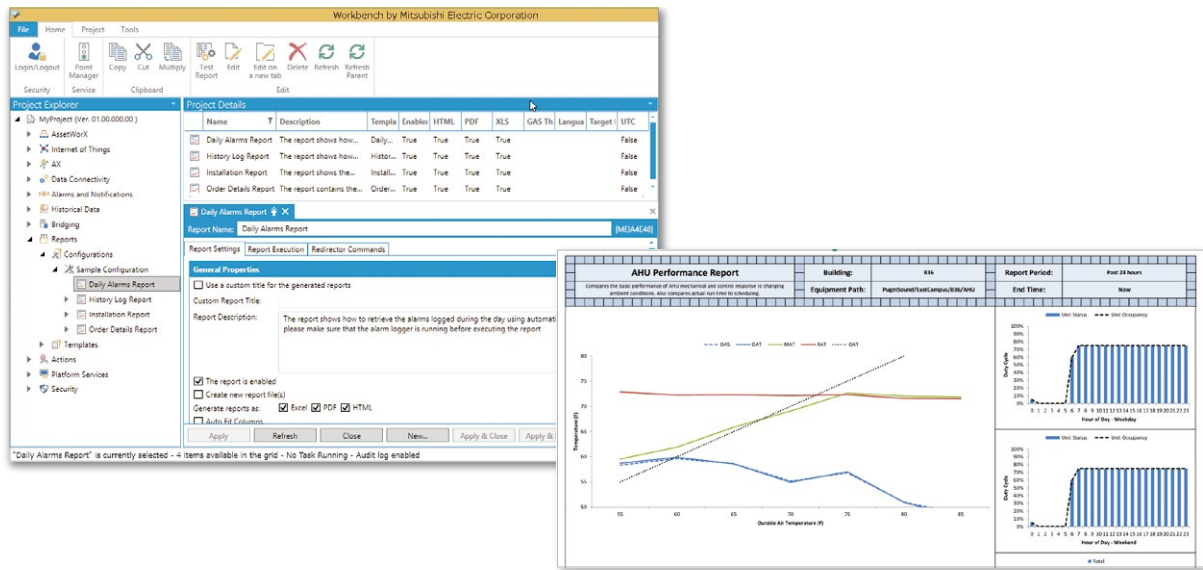

Workbench

■ Centralized project management

Workbench is the multi-functional, centralized project management tool and configuration environment for all GENESIS64™ server applications, making development more efficient and minimizing design time for any application. Configure assets and historical logging from the same screen. Users can configure and manage their entire GENESIS64™ application from any workstation.

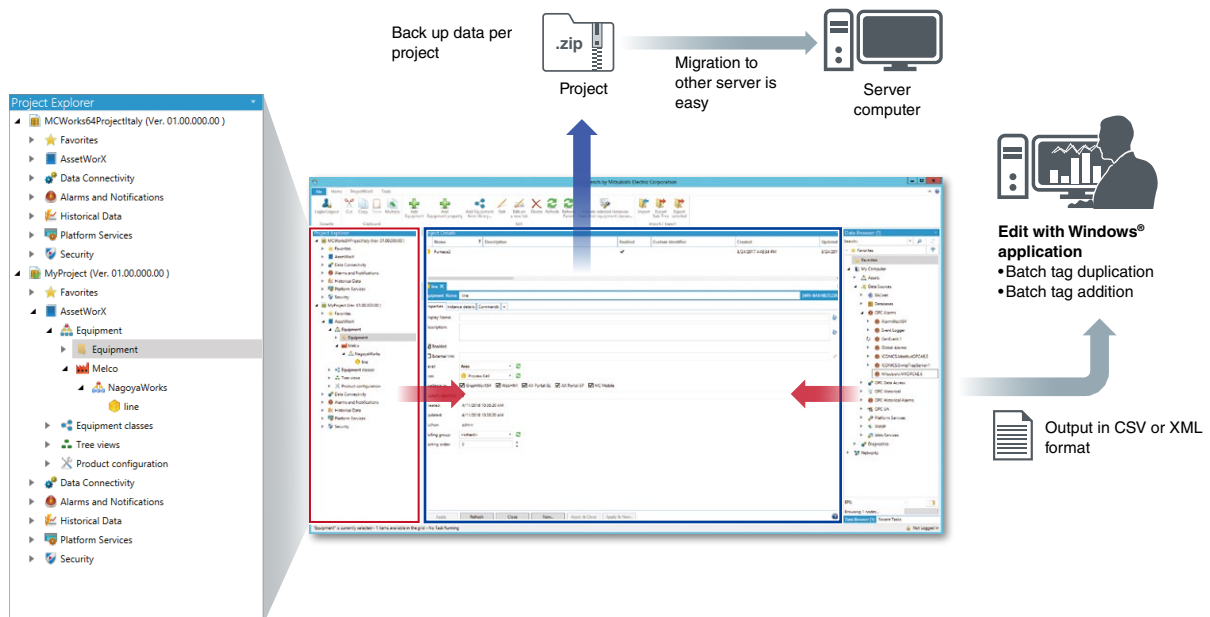

Project tree
 Development by intuitive operation with drag & drop

Operator role

Engineer role

Executive role

System integrator role

Functions

Energy AnalytiX® Option

■ Visualization and analysis of energy consumption

Energy AnalytiX® provides real-time data collection and visualization of energy consumption such as electric, gas, and other utilities. It enables the calculation of specific CO₂ emissions data and other energy metrics at any level of your organizational hierarchy, making it easy to uncover energy efficiency offenders and reduce overall energy costs.

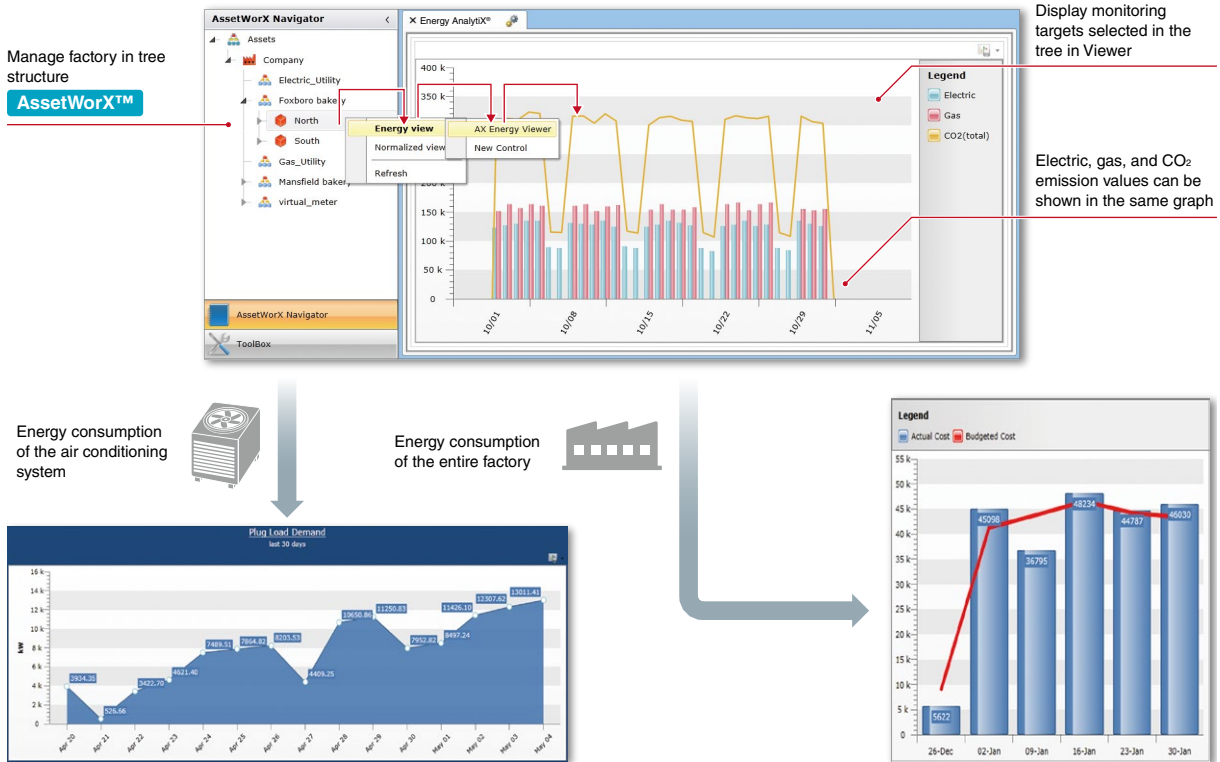

Quality AnalytiX® Option

■ Quality control

Quality AnalytiX® enables operators, quality personnel, manufacturing engineers, and executives to view SPC^{*1} and quality data, along with other production parameters impacting product quality. Apply any of the extensive set of built-in calculations to any process variable to drive corrective actions based on process trends.

*1. SPC: Statistical Process Control



Facility AnalytiX® Option

■ Advanced fault detection and diagnostics (FDD) technology

Facility AnalytiX® incorporates customizable fault rules to predict faults and failures, weigh the probability of equipment failure, and advise personnel of immediate preventive actions that can be taken, improving safety and optimizing energy savings. An extensive library of standard HVAC*1 and process equipment diagnostic models minimizes configuration, while a rules editor enables intuitive customization and equipment diagnostic modeling.

*1. HVAC: Heating, Ventilation, and Air Conditioning

► Customizable fault definitions (rules) with algorithms to determine probable causes



Equipment data



Specifications



Weather information

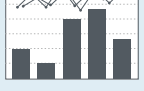

Trend graph



Know-how

No.	Product name	Production area	Starting date	Updated date	Consumable unit
1	Product A	Area A	200325	200505	102
2	Product B	Area B	200115	200714	100
3	Product C	Area C	201030	200103	305
4	Product D	Area D	200222	200908	205
5	Product E	Area E	200410	200214	453
6	Product F	Area F	200605	201103	110

Production data

Drag a column header and drop it here to group by that column

Photo	Name	Date/Time	Fault	Area
	JCI VAV Model: 2514A	10/25/2010 11:26 AM	Efficiency less than 80%	BR.BR1.Floor1

Details Causes Performance Chart

Possible Causes

- Tuning problem with airflow feedback controller loop
- Zone temperature sensor drift/failure
- Supply air static pressure too low
- Scheduling conflict with AHU
- Minimum airflow setpoint too high
- Inappropriate zone temperature setpoint
- AHU supply air too cool
- Damper actuator stuck or failed
- Tuning problem with zone temperature feedback control loop
- Maximum airflow setpoint too low
- Discharge temperature sensor drift/failure

	JCI VAV Model: 2514A	10/25/2010 7:09 PM	Air flow VS fan speed ratio less than 10%	BR.BR1.Floor5
---	----------------------	--------------------	---	---------------

Check alarms received from equipment and visualize fault causes in order of probability for troubleshooting

► Application example: Detect a fan speed abnormality of air conditioning system

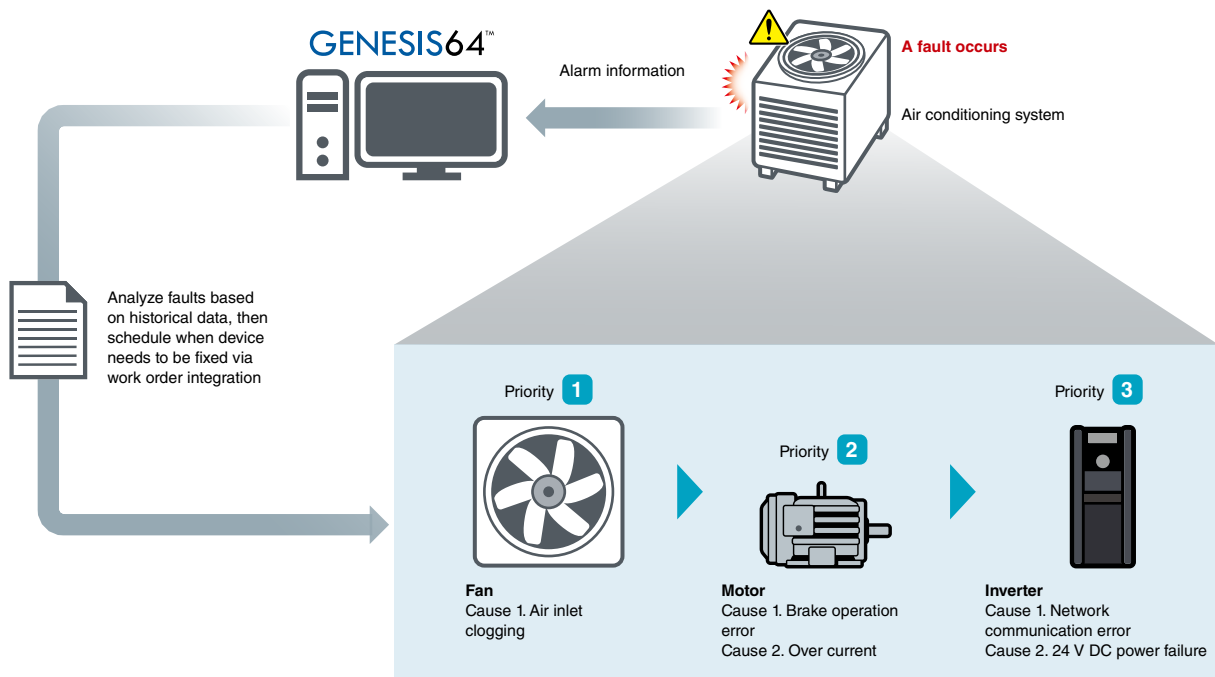

CFSWorX™ Option

■ Monitoring of field service workers and maintenance personnel

CFSWorX™ is useful for monitoring of field service workers from a central location. It determines which worker is best for the maintenance task according to location, schedule, availability, and skill level. CFSWorX™ can even instantly connect remote workers to subject matter experts via its video expert capability.

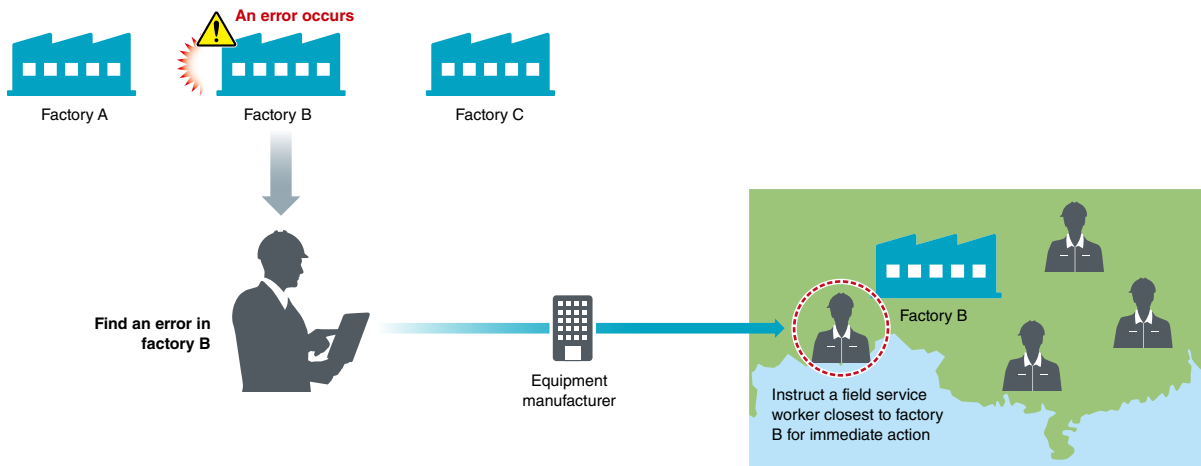

IoTWorX™ Option

■ IoT communication function for Cloud

IoTWorX™ combines cutting-edge micro SCADA software technology with integrated SCADA, analytics, and mobile solutions running in the cloud. It includes open connectivity to assets, secure cloud communications, and built-in real-time visualization and analytics.

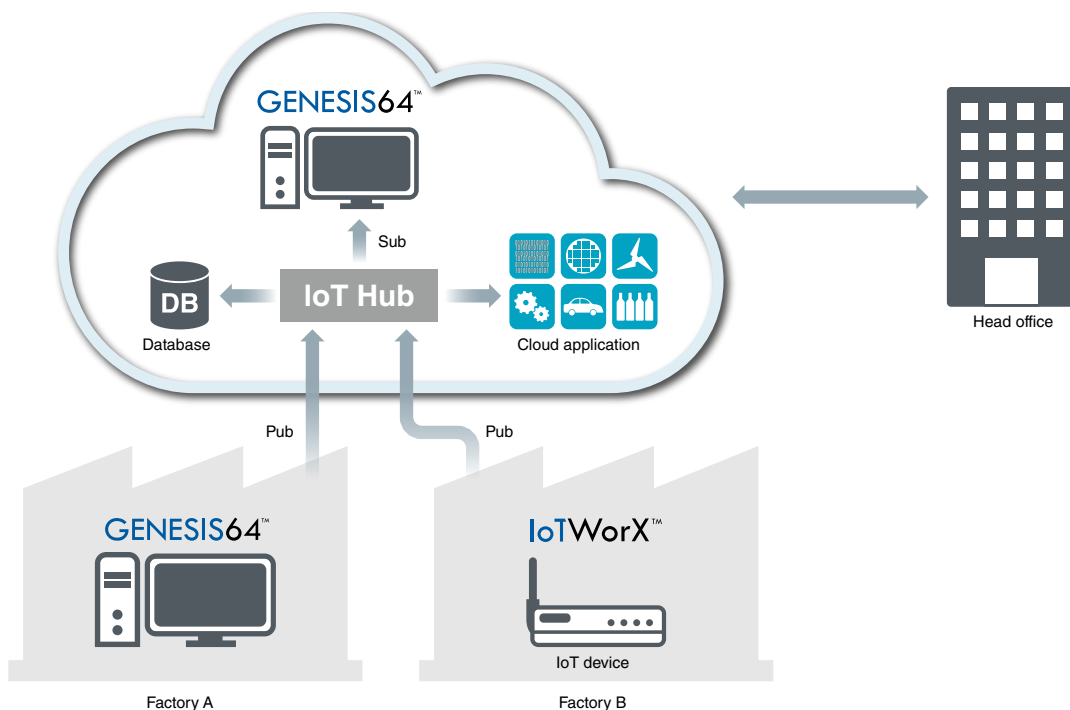

Open connectivity

GENESIS64™ supports industry standard communications such as OPC™, OPC UA, MODBUS®, BACnet®, MQTT, web services, and various databases such as SQL Database, Oracle®, and ODBC can be directly connected without an OPC server. Simple device discovery on the network makes integration seamless and efficient. The Mitsubishi Electric Factory Automation (FA) Connector supports MELSEC iQ-R and iQ-F Series. Other devices that do not require an OPC server will be added in the future.

■ Mitsubishi Electric controllers supported by GENESIS64™

Model	Connection path				Remarks
	USB	Serial	Ethernet	CC-Link IE Control	
MELSEC iQ-R/Q Series CPU module	●	●	●	●	R□CPU, R□ENCPU, R□SFCPU, R□PCPU, and R□PSFCPU are supported.
MELSEC iQ-F/FX/L Series CPU module	●	●	●	-	FX5CPU is supported. (FX5UCCPU does not support USB and serial expansion board.)
GOT2000 Series/SoftGOT2000	-	-	●	-	-

■ Various protocols are supported

Various protocols such as OPC UA, BACnet®, MODBUS® are supported, allowing configuration of a monitoring system connected with various production lines, equipment, and devices.

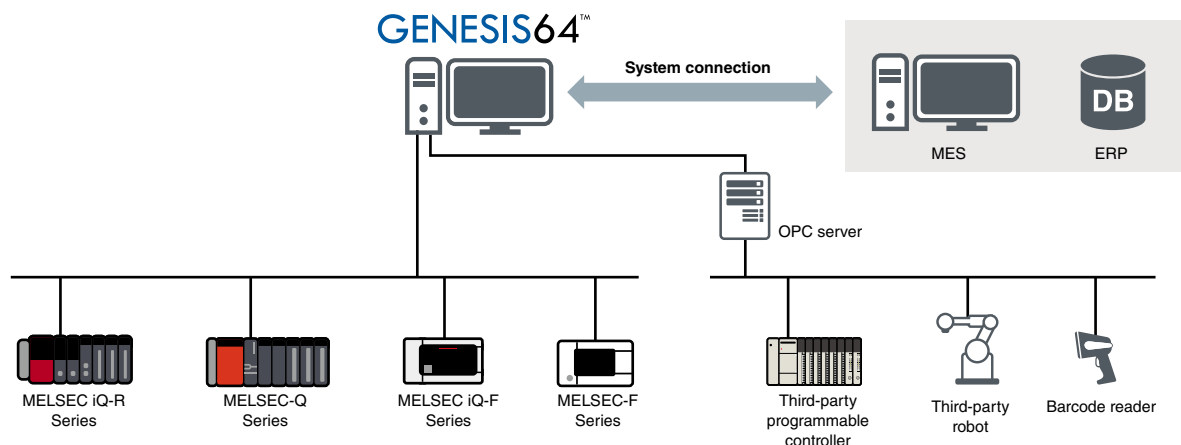

For the supported networks, please refer to “Connection to devices/external services” of the function list (A server product) on page 37.

■ Recommended OPC server Option

DeviceXPlorer OPC server for GENESIS64™

Communication software supporting programmable controller CPU module, C Controller module, motion CPU module, and GOT (HMI). Data retrieval via networks such as Ethernet and CC-Link and data communication through OPC DA, OPC UA, and OPC UA Pub/Sub are supported.

[Supported models]

MELSEC programmable controller, GOT (HMI) and other Mitsubishi Electric products*1

*1. More than 230 devices are supported.

[Supported networks]

Ethernet, serial, CC-Link, CC-Link IE, MELSECNET/H, etc.

[Supported areas]

Asia, Europe, North America, Latin America, Africa

Converter-GOT

■ GOT (HMI) screen conversion

GOT (HMI) screen data created with GT Designer3 can be converted to GraphWorX™ data. Creating additional screens for GENESIS64™ is unnecessary, thereby reducing engineering time. A remote monitoring system enabling monitoring and operation with the GOT (HMI) in production sites and GENESIS64™ in the office can be configured.

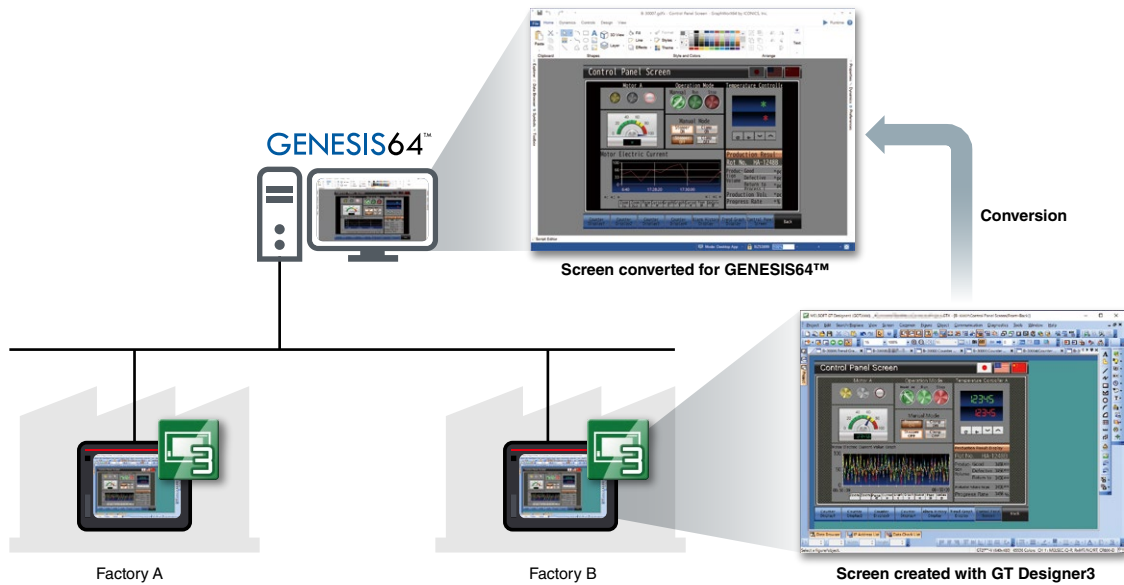

Asset Builder Option

■ Process screen configuration support

By importing process programs created with engineering software GX Works3 to GENESIS64™, monitoring screens for the process system can be created. Process tag information can be automatically assigned to faceplates and tuning screens, setting process tags with GENESIS64™ is unnecessary.

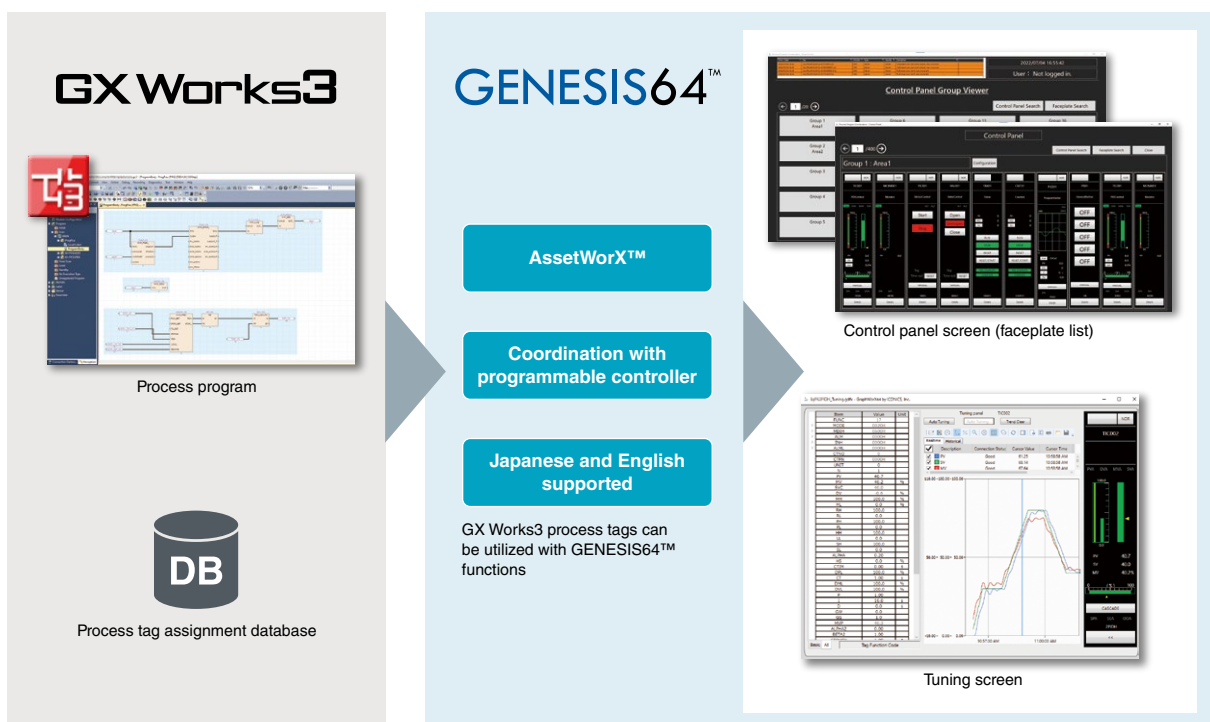

Edgexcross compatible

GENESIS64™ operates on Edgexcross compatible industrial computer such as MELIPC MI5000. Utilizing Edgexcross applications, production data collection and analysis are possible.



Edgexcross application (MELSOFT Mailab)
One software enables real-time diagnosis and offline analysis of production data

GENESIS64™
Visualize facility and equipment where a sign of error is detected, allowing maintenance before it happens.

GENESIS64™
Visualize facility and equipment status and KPI information sent from Edgexcross.

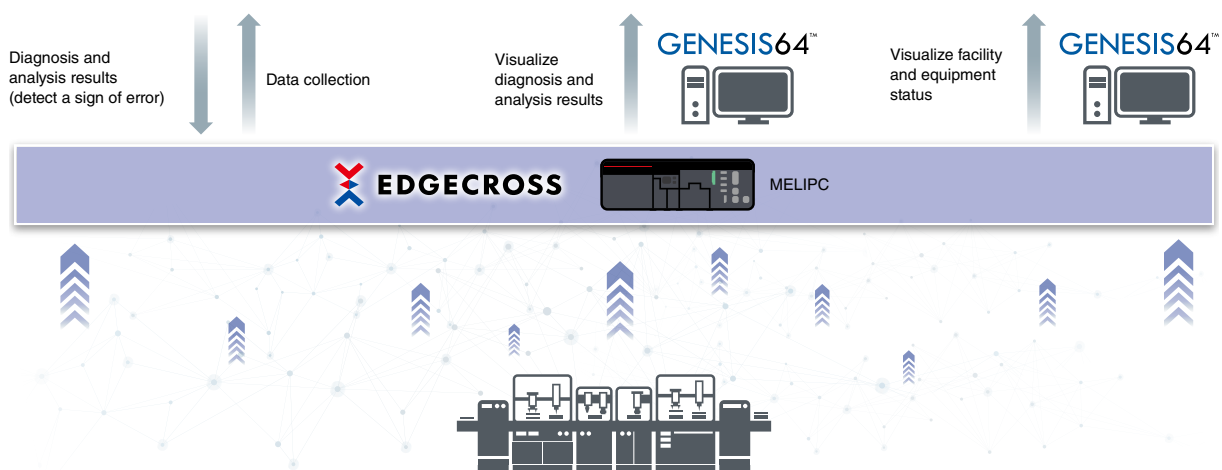

Global standard compliance

■ Configure ANSI/ISA-18.2 compliant projects

AlarmWorX™ provides functions to comply with ANSI/ISA-18.2, a standard for management of alarm systems. GENESIS64™ helps promote global compatibility of customer's systems through compliance with internationally mainstream alarm system.

■ Configure ANSI/ASHRAE Standard 135-2008 compliant projects

BACnet® connection function used for Building Automation system is provided. GENESIS64™ enables connection complying with ANSI/ASHRAE Standard 135-2008.

■ Configure FDA 21 CFR Part 11 compliant projects

GENESIS64™ provides functions to configure a system complying with FDA 21 CFR Part 11 which specifies electronic record management concerning food and pharmaceutical development and manufacturing.

Operator role

Engineer role

Executive role

System Integrator role

Functions

GENESIS64™ product configuration

GENESIS64™ licenses are available as a server license, client license, and optional license. Please select products by referring to steps on page 38 and later.

Please refer to page 48 for the product list.

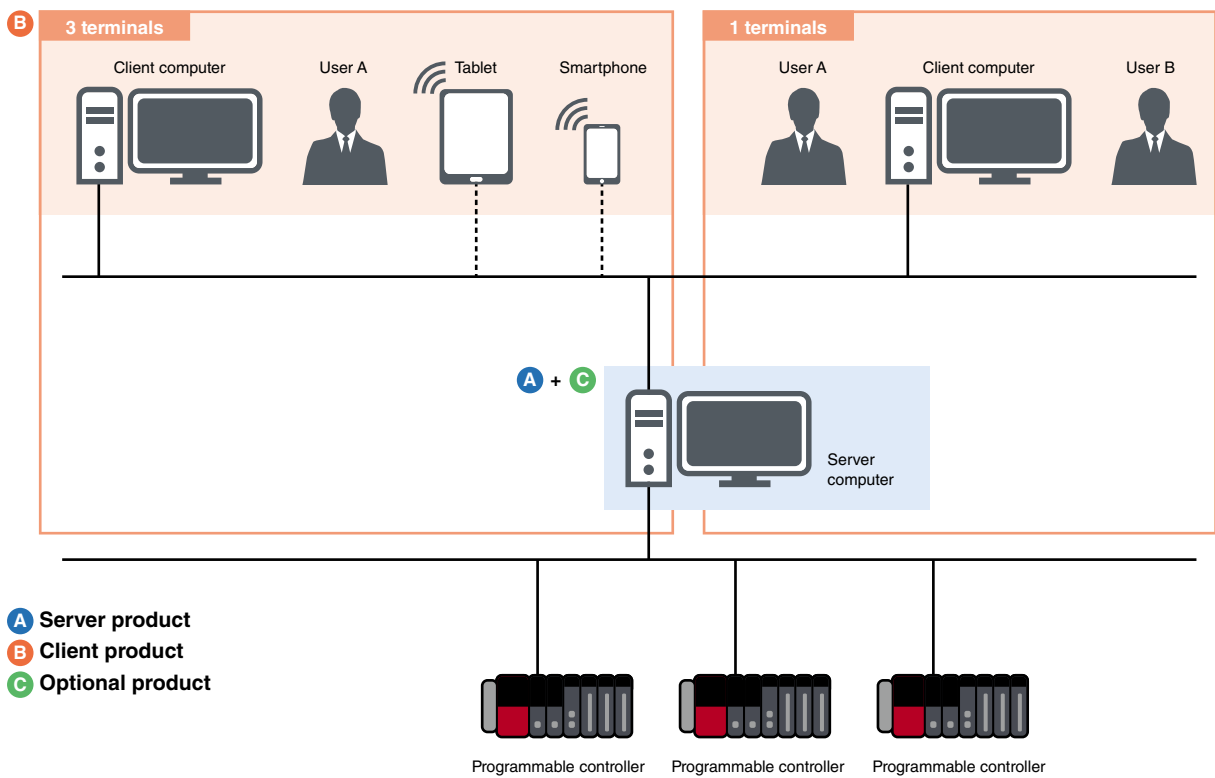

■ Function list (A server product)

●: included -: not included

		GENESIS64™ Basic SCADA	GENESIS64™ Advanced
How to count tags		Static Tag (count all tags)	Dynamic Tag (count tags in use)
Number of tags		75, 150, 500, 1500, 5k, 15k, 30k*1	75, 150, 500, 1500, 5k, 15k, 50k, 100k, 250k*1
Server function			
AlarmWorX™ Server & Logger Hyper Alarm Server & Logger	Alarm visualization	●	●
WebHMI™ Server	Remote monitoring (for web browser)	●	●
AssetWorX™ Server	Asset management using a hierarchical tree structure	●	●
Hyper Historian™ Express*2	High-speed/highly reliable data collection	●	●
Redundant/Distribute	Redundant/distributed server	-	●
AlertWorX™	Alarm notification by email	●	●
MobileHMI™ Server	Remote monitoring (for mobile application)	●	●
Workflow	Programming by flowchart	●	●
Hyper Historian™ Standard/Enterprise*2	High-speed/highly reliable data collection (extended version)	Option	Option
BridgeWorX™	Transaction-based processing by flowchart	● (5 transactions)*3	● (5 transactions)*3
ReportWorX™	Automated reporting	Option	Option
Connection to devices/external services			
Mitsubishi Electric FA Connector	Mitsubishi Electric products connection (direct driver)	●	●
OPC Classic	OPC Classic connection	●	●
OPC UA	OPC UA connection	●	●
Databases (GridWorX™ Server)	Database access	●	●
MODBUS®	MODBUS® connection	●	●
BACnet®	BACnet® connection	Option	●
SNMP	SNMP connection	●	●
Web Services	Web service access	●	●
IoT Publisher (MQTT/AMQP/JSON)	Data transferring to cloud service	●	●
Client function			
GraphWorX™	Graphic creation/visualization	● (without 3D function)	●
TrendWorX™ Viewer	Real-time and historical trends	●	●
AlarmWorX™ Viewer	Alarm visualization	●	●
EarthWorX™ Viewer	Monitor widely dispersed assets	●	●
KPIWorX™	Dashboard creation	●	●
ReportWorX™ Express	Manual reporting	●	●
Workbench	Centralized project management	●	●
Asset Navigator	Asset tree display	●	●
GridWorX™ Viewer	Database access	●	●
System configuration support function			
Converter-GOT	GOT (HMI) screen conversion	●	●
Asset Builder	Process screen creation support	Option	Option

*1. Select additional tag option to increase tag count if needed.

*2. For functional differences, please refer to the function list (Hyper Historian™ products) on page 38.

*3. GENESIS64™ server products include 5 transactions. Purchase optional BridgeWorX™ add-on transactions as needed.

1

Select a server product

Select either GENESIS64™ Basic SCADA or GENESIS64™ Advanced according to the number of tags and necessary functions referring to the product list on page 48 and function list (A server product) on page 37.

For tags, please refer to page 40.

2

Select client products

The maximum number of client devices*1 simultaneously accessing the monitoring control screen of the GENESIS64™ server during system monitoring. Select client products according to the estimated maximum number of client devices.

*1. Count as "2" when the same user accesses from both computer and smartphone simultaneously. Count as "1" when a different user accesses from a shared computer.

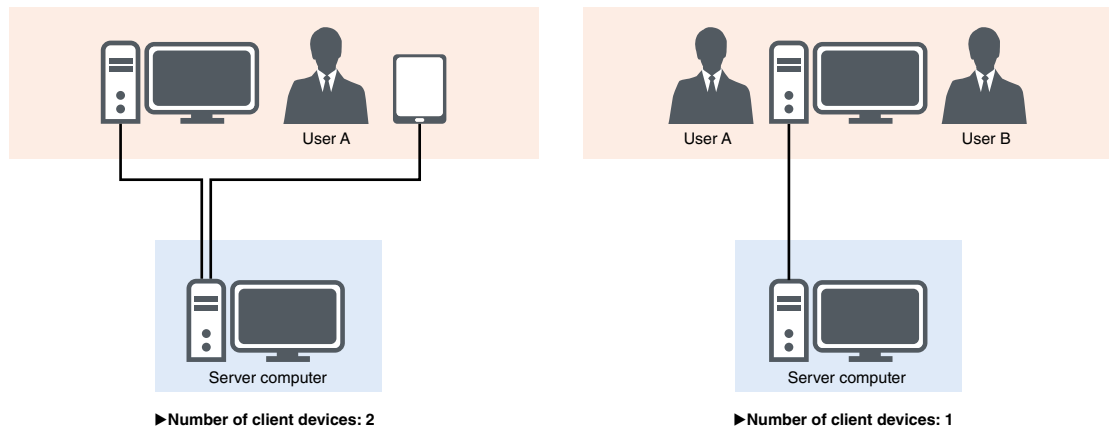

Device	Accessing method	Necessary product
Computer	Browser*2	WebHMI™
Mobile device (smartphone, tablet)	Browser*2	WebHMI™
	Application*3	WebHMI™ or MobileHMI™

*2. Please refer to the operating environment on page 47 for supported browsers.
 *3. To use the application, please search for "MobileHMI™" in App Store® or Google Play™.

3

Select optional products

Select optional products from the product list according to selected functions.

Function list (Hyper Historian™ products)

Function	Hyper Historian™ Enterprise (GEN64-HH-ENT)	Hyper Historian™ Standard (GEN64-HH-STD)	Hyper Historian™ Express (included in GENESIS64™ server product)
High-speed data collection	●	●	●
Collected data calculation/storage	●	●	-
Collection/accumulation distribution	●	-	-
Server redundancy	●*4	-	-
How to count tags	Tags are counted separately from the server product		Tags are counted as GENESIS64™ tags
Number of tags	75, 150, 500, 1500, 5k, 15k, 50k, 100k, 250k, 500k, 1M		Same as GENESIS64™ tag count

*4. Hyper Historian™ Redundant (GEN64-HH-R) for redundant system is available. Please refer to the product list on page 48 for details.

option
1

System configuration options

GENESIS64™ supports several levels of highly reliable/high availability systems. To determine the best fit for your application needs, please refer to the system configuration below.

■ Redundant server configuration (supported by GENESIS64™ Advanced only)

- Redundant GENESIS64™ Advanced servers (continuous monitoring is assured by automatic screen switching)
- Redundant Hyper Historian™ servers (secure data by continuous historical data collection)
 - ▶ ① GENESIS64™ and ② Hyper Historian™ Enterprise (GEN64-HH-ENT) are necessary for each control and standby server

■ Distributed server configuration

- Distributed Hyper Historian™ servers for collection/accumulation function
 - ▶ Hyper Historian™ Enterprise (GEN64-HH-ENT) is necessary

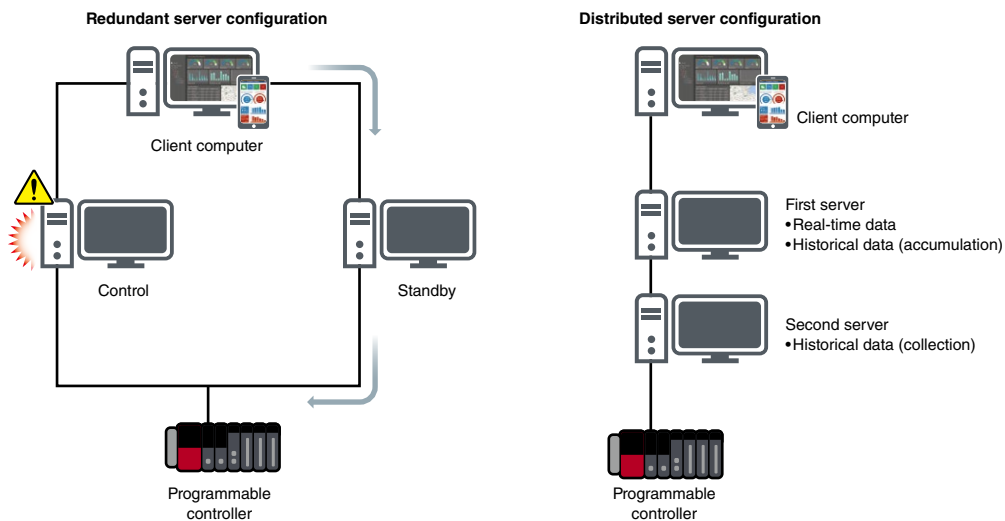

option
2

Select software or hardware license

License is applied to either a server computer or USB hardware key. Choose either referring to the table below.

Options	Server computer	USB hardware key
Image		
Benefits	<ul style="list-style-type: none"> • Purchasing of USB hardware key is unnecessary • No risk of accidental loss of USB hardware key 	<ul style="list-style-type: none"> • License migration from development server to production server is easy • In case of an issue with the production server, the license can easily be transferred to another server

Please refer to page 44 for license registration procedure.

What are tags?

Tags are data sets for GENESIS64™ to access external devices. The number of data sets used in runtime of GENESIS64™ are counted. The example below shows two tags being counted, one real-time value of a programmable controller = 25 and another from a SQL statement that refers to last week's temperature = 20.

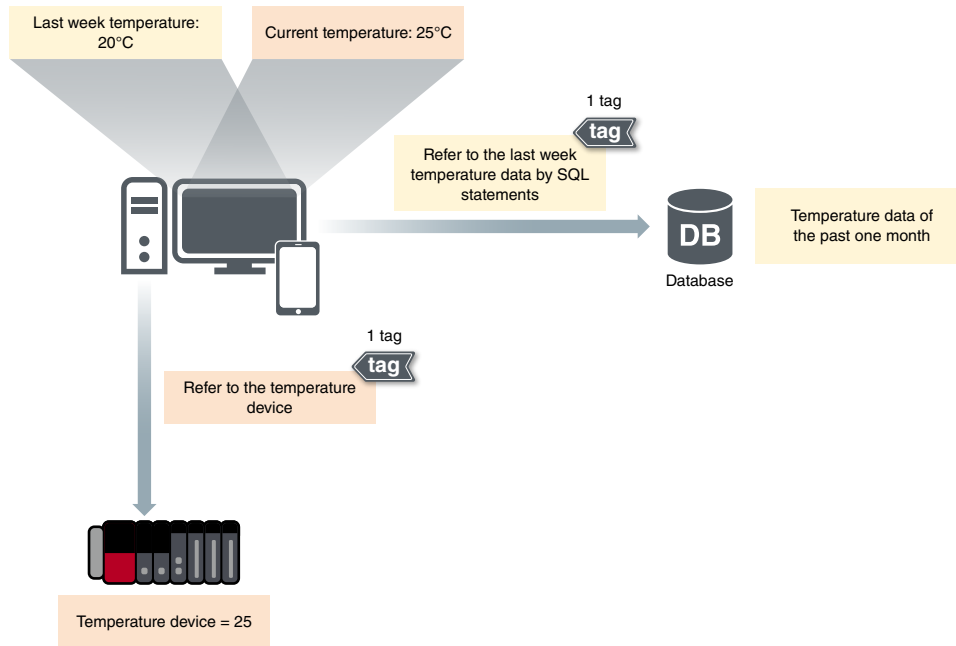

■ In the case of Hyper Historian™

- When using Hyper Historian™, tags are counted separately from GENESIS64™*1*2
- “The number of historical data collection settings” are counted as the number of tags

Difference of counted tag

Type of data	Real-time data	Historical data
When using Hyper Historian™	GENESIS64™ tag	Hyper Historian™ tag
When using Hyper Historian™ Express	GENESIS64™ tag	GENESIS64™ tag

*1. When using historical data collection/accumulation (Hyper Historian™ Express) included in GENESIS64™ server product (refer to the product list on page 48), a tag is counted as GENESIS64™ tag.
 *2. Historical data collection setting that exceeds the number of tags of Hyper Historian™ in use cannot be counted as GENESIS64™ tag.

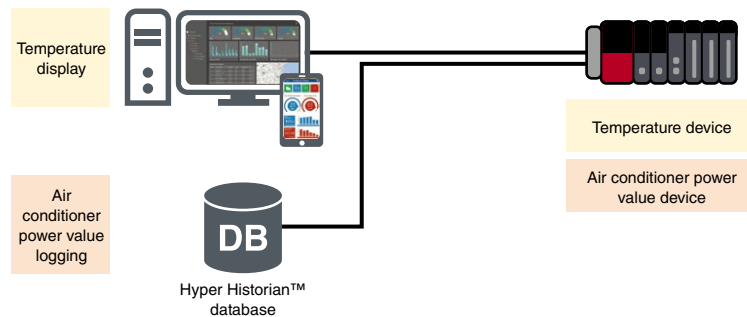

How to count tags -GENESIS64™ Basic SCADA-

Data to be used for displaying alarm conditions and screen/table need to be defined as asset tag on AssetWorX™.

Example

Display average temperature of two rooms

Number of asset tags are defined during configuration of the tag database in AssetWorX™. Counting method of tags differs according to building method of asset tags.

Building method 1

To assign an asset tag to display “average temperature of room 1 and 2” (when calculating the average temperature of room 1 and 2 in the programmable controller outside the SCADA), the following three tags are necessary: “room 1 temperature,” “room 2 temperature,” and an expression for “average temperature of room 1 and 2”

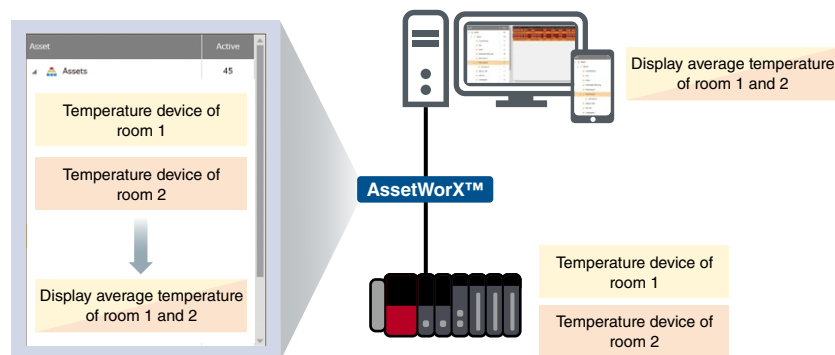

Building method 2

To assign a defined formula to calculate “average temperature of room 1 and 2” on the display, two asset tags “temperature of room 1” and “temperature of room 2” are necessary.

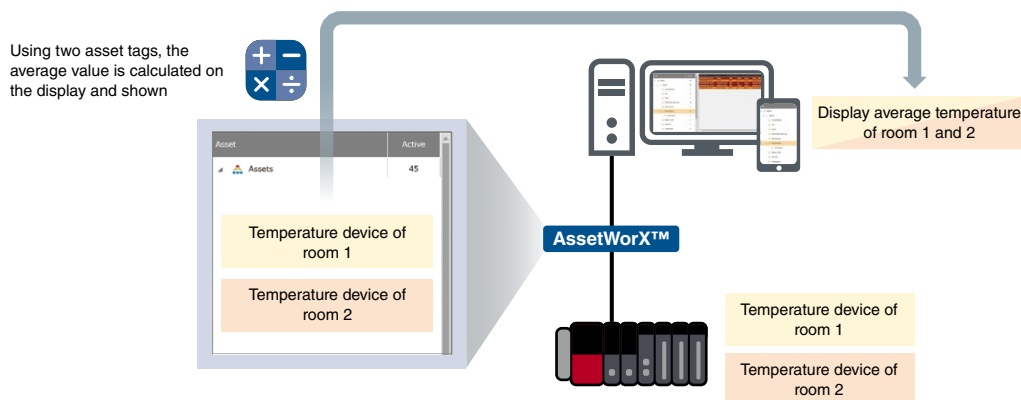

■ Timing of counting tags

All tags are counted at a start of a server according to the configuration of the AssetWorX™ tag database.

■ How to count tags when accessing from multiple clients

Tags are counted at the timing of server starting, the number of clients being accessed will not affect the number of tags counted.

■ How to count tags when Hyper Historian™ is used

Both asset tags and Hyper Historian™ tags are counted.

How to count tags -GENESIS64™ Advanced-

Tags are counted by data set unit for read and write.

Example 1

Display average temperature of two rooms on the screen

Only one data set is displayed with this setting, however, it is counted as **two tags** since two data sets are read.

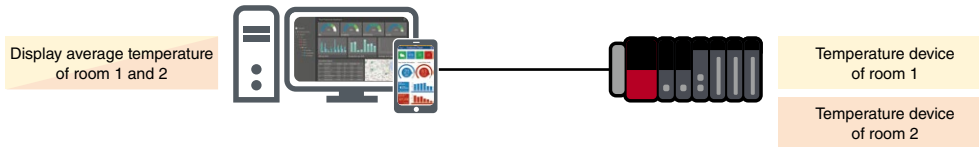

Example 2

Set temperature device of a programmable controller to “screen display” and “alarm conditions”

Only one “temperature” data set is accessed for read and write with this setting, it is counted as **one tag**.

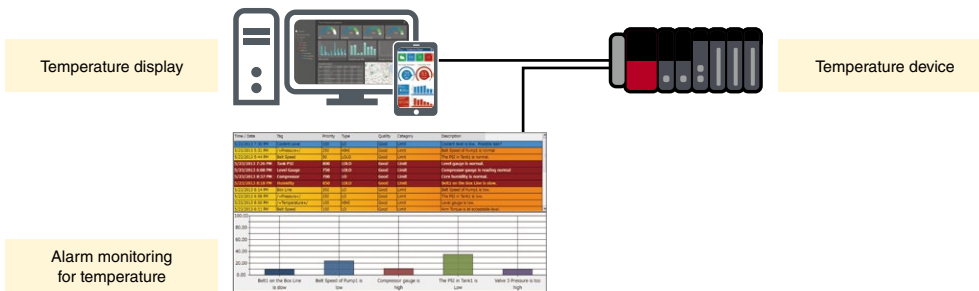

■ Timing of counting tag- Catch and release

Tags are counted in runtime at the start of reading from/writing to external data sources. GENESIS64™ Advanced stops counting (releasing tags) upon completion of reading from/writing to external data (e.g. closing a screen).

Example

System to display temperature device of a programmable controller and monitor alarm of operating device

Tag is counted as **one tag** upon start of alarm monitoring. **Another tag** is counted when opening a display.

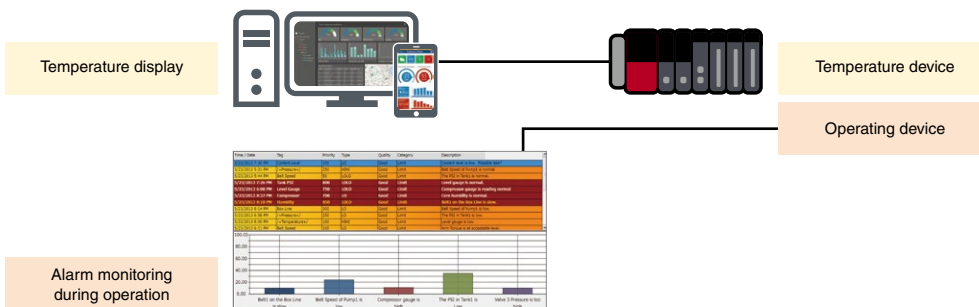

Tag count increase and decrease

●: Counted -: Not counted

	Start	Alarm monitoring start	Display	Close display*1	Alarm monitoring end
Temperature tag	-	-	●	-	-
Operating tag	-	●	●	●	-
Total tags	0	1	2	1	0

*1. After closing the screen, connection is maintained for a while and counting status is kept to promptly redisplay.

■ How to count tags when viewed from multiple clients

When viewing the same screen, the total number of tags on one screen are counted. When accessing other screens, the total number of tags on accessed screens are counted.

Example 1

When multiple users display the same screen (same data set)

Only room 1 temperature is read, it is counted as **one tag**.

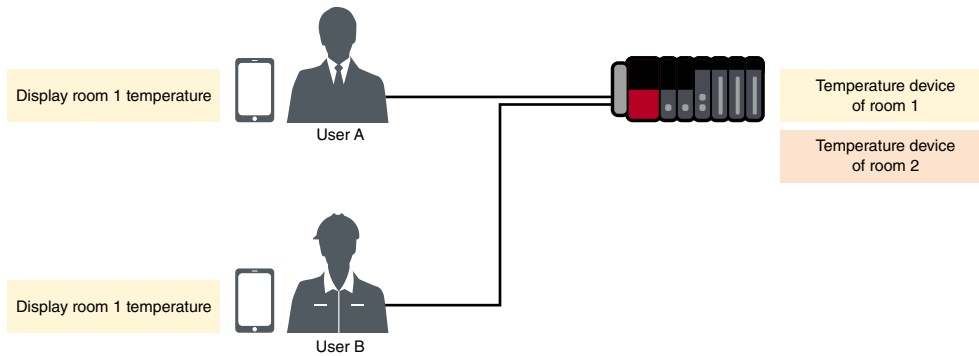

Example 2

When multiple users display different screens (different data sets)

Room 1 and 2 temperatures are read, it is counted as **two tags**.

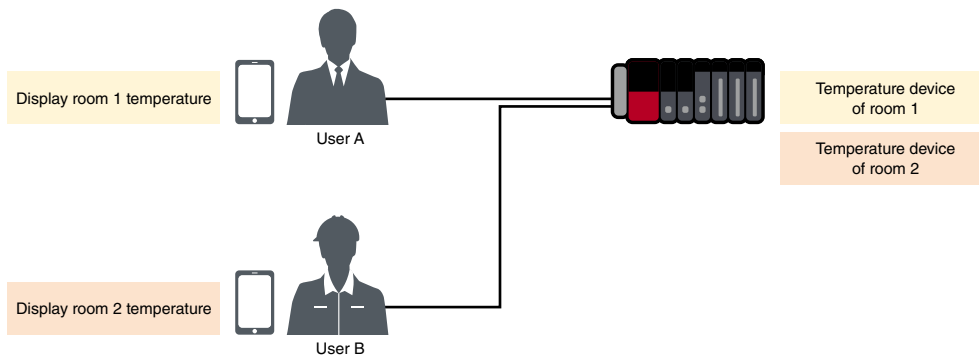

License registration procedure

Upon purchase of a product, a license to use GENESIS64™ is provided.

Software license

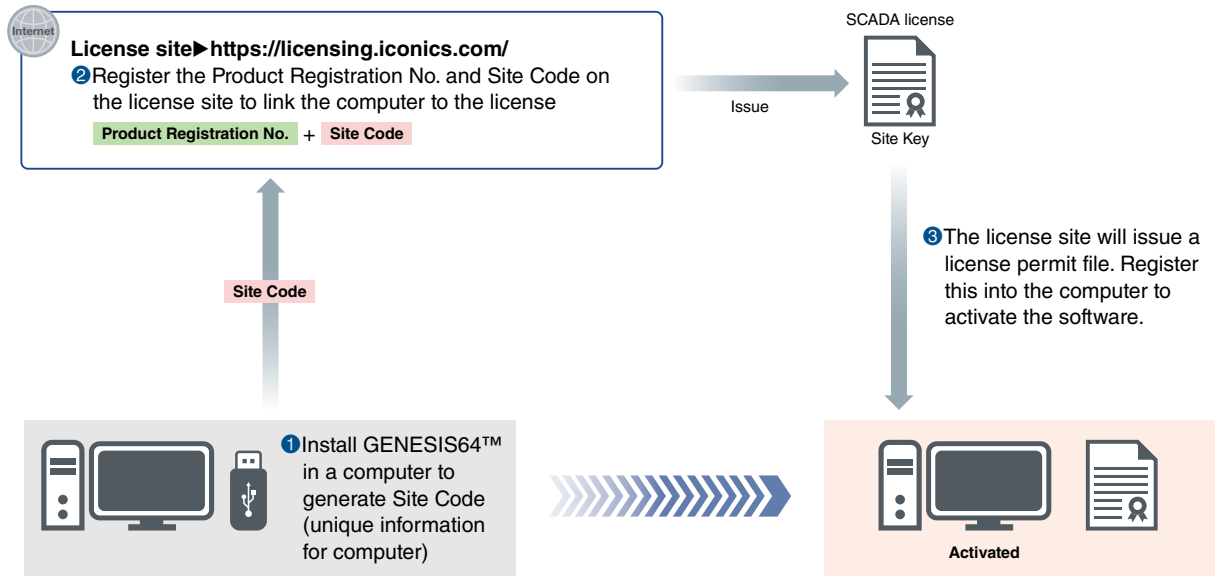

USB hardware key

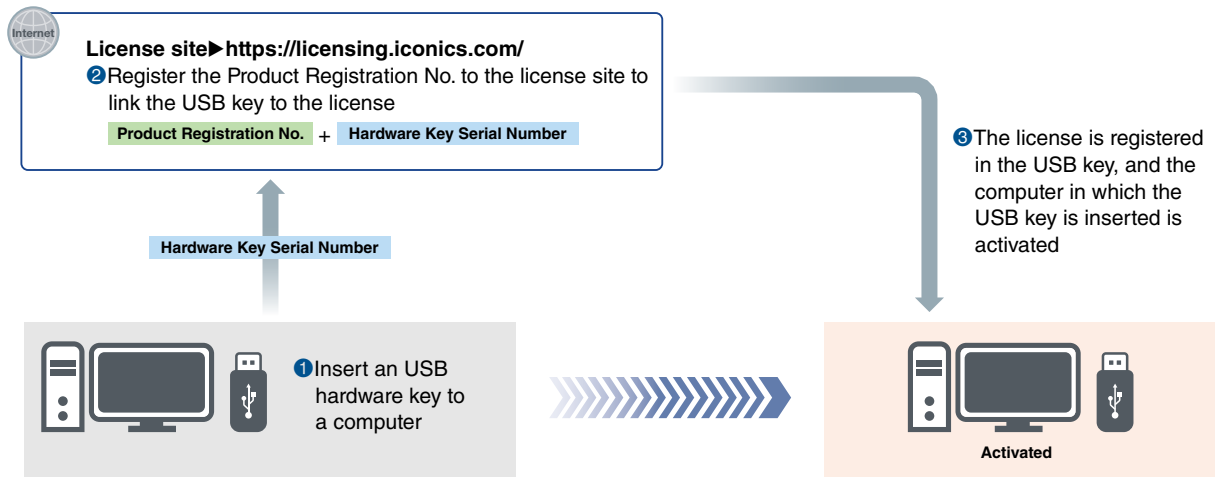

Discover the latest information in Factory Automation

Factory Automation Global website

Mitsubishi Electric Factory Automation provides a mix of services to support its customers worldwide. A consolidated global website is the main portal, offering a selection of support tools and a window to its local Mitsubishi Electric sales and support network.

■ **From here you can find:**

- Overview of available factory automation products
- Library of downloadable literature
- Support tools such as online e-learning courses, terminology dictionary, etc.
- Global sales and service network portal
- Latest news related to Mitsubishi Electric factory automation

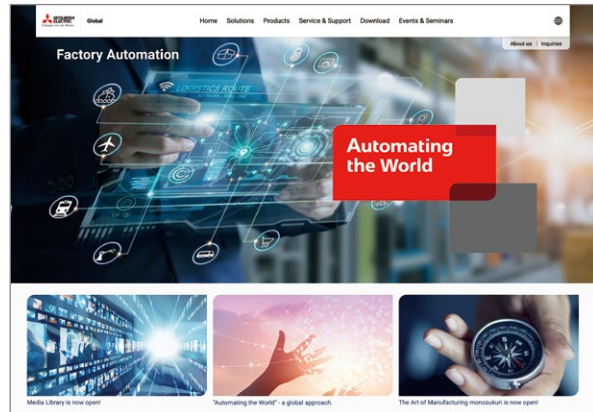

**Mitsubishi Electric Factory Automation
Global website:
www.MitsubishiElectric.com/fa**

Online e-learning

An extensive library of e-learning courses covering the factory automation product range has been prepared. Courses from beginner to advanced levels of difficulty are available in various languages.



■ **Beginner level**

Designed for newcomers to Mitsubishi Electric Factory Automation products gaining a background of the fundamentals and an overview of various products related to the course.

■ **Basic to Advanced levels**

These courses are designed to provide education at all levels. Various different features are explained with application examples providing an easy and informative resource for in-house company training.

Find information on products, factory automation, e-F@ctory solutions and other topics

Follow us on Social Media

■ **YouTube**



■ **LinkedIn**



■ **X**

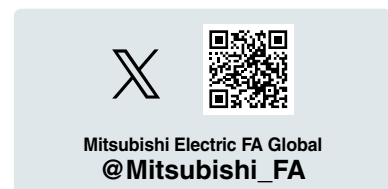

Innovative next-generation, e-Manual

e-Manual Viewer

The e-Manual viewer is a next-generation digital manual offered by Mitsubishi Electric that consolidates factory automation products manuals into an easy-to-use package with various useful features integrated into the viewer. The e-Manual allows multiple manuals to be cross-searched at once, further reducing time for setting up products and troubleshooting.

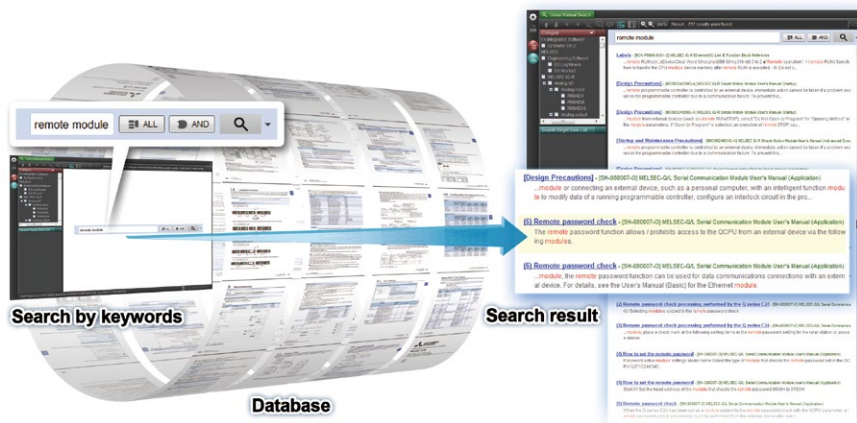

Key features included

- One-stop database containing all required manuals, with local file cache
- Included with GX Works3 engineering software
- Also available in tablet version
- Easily download manuals all at once
- Multiple users can share the latest manuals and knowhow with document sharing function
- Directly port sample programs within manuals to GX Works3
- Downloaded manuals are usable offline



e-Manual Create

e-Manual Create is software for converting word files and chm files to e-Manual documents. e-Manual Create allows users to directly refer to Mitsubishi Electric e-Manuals from user's customized device maintenance manuals and such, supporting quick troubleshooting and reduction in document creation process.

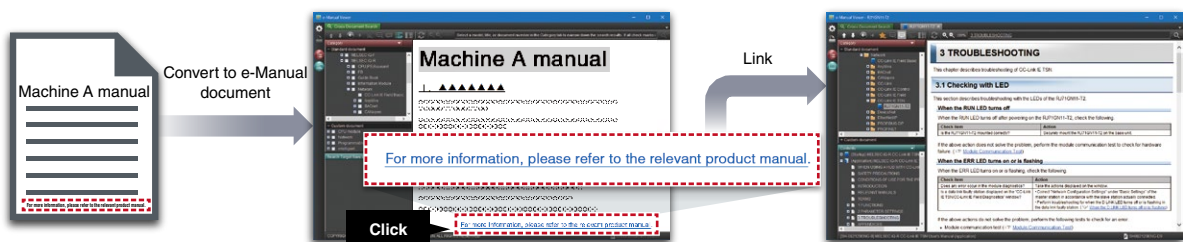

* To obtain the Windows® version of e-Manual Viewer and e-Manual Create, please contact your local Mitsubishi Electric sales office or representative.

Server product

System requirements (see <https://documentation.iconics.com> for the latest updates)

Item	Specifications
CPU	Quad Core 64-bit processor or better
RAM	8 GB or larger
Storage	4 GB or larger (adequate physical memory for the actual data to be saved)
Virtual memory	16 GB or larger (2x RAM capacity recommended)
Operating System (OS)*1	64-bit Windows® OS
Display	Resolution: 1024 × 768 pixels or more
Database*2	Microsoft® SQL Server®
Microsoft® .NET Framework	4.8, 3.5
Web server*3	Microsoft® Internet Information Services (IIS) 7.0 or later
Web browser*3	HTML5 WebHMI™ displays: Microsoft Edge®, Google Chrome™, Safari®, Mozilla Firefox® WPF WebHMI™ displays: Microsoft Edge®(in Internet Explorer® mode), Internet Explorer® 11**4

*1. Please refer to "Supported OS" table for details.

*2. Please refer to "Supported database" table for details.

*3. Use when displaying a screen on the client. For details on supported web browsers, please refer to "Supported web browser" table.

*4. Internet Explorer® 11 is only supported for Windows® Presentation Foundation (WPF) WebHMI™, not for HTML5 WebHMI™.

Supported OS

OS*5	GENESIS64™	Hyper Historian™	Energy AnalytiX® Facility AnalytiX® Quality AnalytiX®
Microsoft® Windows® 11*6	●	●	-
Microsoft® Windows® 10 x64*7	●	●	-
Microsoft® Windows Server® 2022	●	●	●
Microsoft® Windows Server® 2019*8	●	●	●
Microsoft® Windows Server® 2016 x64	●	●	●
Microsoft® Windows Server® 2012 R2 x64*9	●	●	●
Microsoft® Windows Server® 2012 x64*9	●	●	●

*5. Operation on Embedded system is not supported.

*6. Operation on Windows® 11 Professional, Enterprise, and IoT Enterprise is supported.

*7. Operation on Windows® 10 Professional, Enterprise, and IoT Enterprise (including 2021 LTSC/2019 LTSC/2016 LTSC) is supported.

*8. Includes Microsoft® Windows Server® IoT 2019.

*9. Operation on Microsoft® SQL Server® 2019 is not supported.

Supported database

Database	GENESIS64™
Microsoft® SQL Azure	●
Microsoft® SQL Server® 2019 (including Express)*10	●
Microsoft® SQL Server® 2017 (including Express)*10	●
Microsoft® SQL Server® 2016 (including Express)*10	●
Microsoft® SQL Server® 2014 (including Express)*10	●

*10. When using Microsoft® SQL Server® Express (free edition), a capacity of one database is limited to 10 GB.

IoT device

System requirements

Item	Specifications
CPU	Intel Atom® 38xx Dual Core/Arm® 32v7 Dual Core, or comparable processor
RAM	2 GB (4 GB recommended)
Storage	32 GB or larger
OS	Raspberry Pi OS Stretch (Arm®32v7) Ubuntu 20.04 (AMD 64) Ubuntu 18.04 (AMD 64) Ubuntu Server 20.04 (AMD 64) Ubuntu Server 18.04 (AMD 64) Microsoft® Windows® (using EFLOW*11)
Microsoft® Azure® service	Microsoft® Azure® IoT Hub (tier S1 or higher), Microsoft® Azure® Storage Account
Communication	Ethernet, Wi-Fi®, or cellular (3G/4G)

*11. For details on EFLOW, please visit Microsoft Corporation's website.

Screen display

Supported web browser

Web browser	HTML5 technology	Windows® Presentation Foundation (WPF) technology
Microsoft Edge®	●	●*12
Firefox®	●	-
Safari®	●	-
Google Chrome™	●	-
Internet Explorer® 11	-	●

*12. Only Internet Explorer® mode (IE mode) is supported.

GENESIS64™ server product

Product name	Model	Number of tags	Outline
GENESIS64™ Basic SCADA	GEN64-BASIC	75, 150, 500, 1500, 5k, 15k, 30k	Server for configuration and runtime with modular licensing for small to medium applications.
GENESIS64™ Advanced*1	GEN64-APP	75, 150, 500, 1500, 5k, 15k, 50k, 100k, 250k	Server for configuration and runtime with comprehensive licensing for large and distributed applications.

*1. Runtime-only license version is available. Please consult us when you are requesting for quotation.

GENESIS64™ client product

Product name	Model	Number of clients	Outline
Client for monitoring control*2*3	WEBHMI-BRWRSR	1, 5, 25, 100, 500	Fully interactive read/write clients for use on desktops, web browsers using WPF or HTML5, or as mobile app clients.
Client for monitoring control*3 (for mobile application)	MOBILEHMI-CLIENT	1, 5, 25, 100, 500	Fully interactive read/write clients dedicated to access via the MobileHMI™ app on smartphones, tablets, or AR devices.

*2. License for development (multiple persons can develop simultaneously on one server) is available.

*3. Read-only and browser-only client licensing is available.

Optional products

Product name	Model	Unit	Outline
Hyper Historian™	GEN64-HH-STD GEN64-HH-ENT GEN64-HH-R	75, 150, 500, 1500, 5k, 15k, 50k, 100k, 250k, 500k, 1M (tag)	Time series data historian collecting large amounts of shop floor data at high speed. STD: Supports performance calculations and predefined aggregates. ENT/R: In addition to the above, supports remote collectors, advanced data compression and redundancy. (Model numbers R include two ENT licenses for redundant system).*4
BridgeWorX™	BRIDGEWORX64	SVR (1 transaction) LITE (5 transactions) STD (25 transactions) ENT (1000 transactions)	Graphical data bridging tool to execute simple to very complex data transaction scenarios between automation and enterprise systems. The number of concurrently executing transactions determines which license to choose.*5*6 GENESIS64™ Advanced and Basic server products include BridgeWorX64 Server with 5 transactions.
ReportWorX™	REPORTWORX64	SVR (1 report) LITE (5 reports) STD (25 reports) ENT(1000 reports)	Report generation engine to configure and run reports on schedule or on demand. Finished reports can be delivered via email, SMS, and file copy. (Supported formats: Excel®, PDF, HTML, CSV). Number of concurrently executing reports determines which license to choose.*6*7
Asset Builder	ASSET-BUILDER-PA	-	This package supports creation of monitoring screens corresponding to the selected templates. The monitoring screen consists with screens used for process system as standard such as faceplates, tuning screen, and control panel screen.
Energy AnalytiX®*8	AX-EA-A	-	Energy monitoring, analysis, and management system delivering rich, real-time visualization for energy demand, consumption and cost.*9
	AX-EA-METER	1, 5, 25, 100, 500, 1500, 5K, 10K (meter)	Additional Energy AnalytiX® meters.
Quality AnalytiX®*8	AX-QA-A	-	This quality control package uses highly specialized Statistical Process Control (SPC) calculations for manufacturing quality management, and drive corrective actions based on process trends.*10
Facility AnalytiX®	AX-FA-A	-	This package provides advanced fault detection and diagnostics significantly reducing system downtime and improving operational efficiency.*11
	AX-FA-ASSET	1, 5, 25, 100, 500, 1500, 5K, 10K (asset)	Additional Facility AnalytiX® assets.
CFSWorX™	CFSWORX	-	This package can alert field service workers to respond to equipment service needs based on location. Worker availability and location is monitored. The package tracks field service worker responses and maintains a full audit trail.
IoTWorX™	IOT-CV IOT-CVCA IOT-CVCA-JSON-500 IOT-CVCA-JSON-5000	1, 5, 25, 100 (device)	A solution package running on IoT devices at the edge to monitor shop floor data in the cloud.*12 IOT-CV: Publish shop floor data to cloud platforms providing bidirectional real-time communication. On-premise visualization for read-only access to local data. IOT-CVCA: In addition to the above, store and forward of historical data points and merge in the cloud. Includes lightweight analytics module for fault detection. IOT-CVCA-JSON-500/5000: In addition to the above, send data in JSON format. Data sharing with third-party applications in the cloud.

*4. For difference of product functions, please refer to the function list (Hyper Historian™ products) on page 38.

*5. Purchase additional BridgeWorX64 transaction packs as needed.

*6. Add-ons to GENESIS64™ Basic SCADA require purchase of special models; contact customer service for details.

*7. Purchase additional ReportWorX64 report packs as needed. The ReportWorX Express functions come at no charge with GENESIS64™ Advanced and Basic servers.

*8. Not available for GENESIS64™ Basic SCADA. Please refer to the function list (server product) on page 37 for details.

*9. License per instrument (meter). This license includes 5 meters.

*10. Separate Hyper Historian™ and GENESIS64™ licenses are required.

*11. License per device (asset). This license includes 5 assets.

*12. This license applies to IoT devices.

USB hardware key

Product name	Model	Outline
USB hardware key	HW KEY-USB	USB device to store server/client /optional license. Just inserting this product to the server will activate stored license.*13

*13. Applying license to the server is possible. Please refer to the license registration procedure on page 44.

Android, Google Chrome, Google Maps, and Google Play are trademarks of Google LLC.
 Apache Kafka and Apache Hadoop are registered trademarks of the Apache Software Foundation.
 Apple, Apple Watch, Safari are trademarks of Apple Inc., registered in the U.S. and other countries and regions.
 App Store is a service mark of Apple Inc.
 Arm is a registered trademark of Arm Limited (or its subsidiaries or affiliates) in the US and/or elsewhere.
 Autodesk is the registered trademark of Autodesk, Inc. in the US and other countries.
 BACnet is a trademark of ASHRAE.
 COLLADA is a trademark of the Khronos Group Inc.
 Edgexcross is a registered trademark of the Edgexcross Consortium.
 Esri is a trademark of Environmental Systems Research Institute, Inc.
 Firefox is the registered trademark of Mozilla Foundation in the US and other countries.
 GENESIS64, Hyper Historian, BridgeWorX, ReportWorX, Energy AnalytiX, Quality AnalytiX, Facility AnalytiX, CFSWorX, IoTWorX, KPIWorX, MobileHMI, WebHMI and their respective modules, Make the Invisible Visible, and ICONICS company logo, are trademarks of ICONICS, Inc.
 Intel Atom is a trademark of Intel Corporation or its subsidiaries.
 Microsoft, Windows, Access, Azure, Bing, Microsoft Edge, Excel, Internet Explorer, SQL Server, and Windows Server are registered trademarks of the Microsoft group of companies.
 MODBUS is a registered trademark of Schneider Electric USA, Inc.
 OPC is a trademark of OPC Foundation.
 Oracle is a registered trademark of Oracle Corporation and/or its affiliates.
 QR Code is a trademark or a registered trademark of DENSO WAVE INCORPORATED in JAPAN, the United States and/or other countries.
 SAP is a SAP and SAP affiliate company registered trademark in Germany and other countries and corresponding common-noun descriptors.
 Wi-Fi is a registered trademark of Wi-Fi Alliance.
 All other company names and product names used in this document are trademarks or registered trademarks of their respective companies.
 Trademark symbols such as "™" and "®" might be omitted in this document.

Precautions before use

This publication explains the typical features and functions of the products herein and does not provide restrictions or other information related to usage and module combinations. Before using the products, always read the product user manuals. Mitsubishi Electric will not be held liable for damage caused by factors found not to be the cause of Mitsubishi Electric; opportunity loss or lost profits caused by faults in Mitsubishi Electric products; damage, secondary damage, or accident compensation, whether foreseeable or not, caused by special factors; damage to products other than Mitsubishi Electric products; or any other duties.

For safe use

- To use the products given in this publication properly, always read the relevant manuals before beginning operation.
- The products have been manufactured as general-purpose parts for general industries, and are not designed or manufactured to be incorporated in a device or system used in purposes related to human life.
- Before using the products for special purposes such as nuclear power, electric power, aerospace, medicine or passenger-carrying vehicles, consult with Mitsubishi Electric.
- The products have been manufactured under strict quality control. However, when installing the products where major accidents or losses could occur if the products fail, install appropriate backup or fail-safe functions in the system.

e-F@ctory

e-F@ctory is the Mitsubishi Electric solution for adding value across the manufacturing enterprise by enhancing productivity, thereby simultaneously reducing maintenance and operating costs, and enabling the seamless flow of information throughout the plant. e-F@ctory uses a combination of factory automation and IT technologies in combination with various best-in-class partner products through its alliance program.



About ICONICS



Make the Invisible Visible™

ICONICS, a group company of Mitsubishi Electric Corporation, serves as the software center of excellence for Mitsubishi Electric's Factory Automation Systems Group. Its visualization, analytics, mobile, IoT, and cloud solutions improve productivity, reduce integration time and operating costs, and optimize asset utilization. ICONICS solutions, combined with the knowledge and industry expertise of Mitsubishi Electric, maximize value to the customer by monitoring and controlling automation processes. ICONICS award-winning software boasts over 375,000 installations in Factory Automation (FA), Process Automation (PA), and Building Automation (BA) customers in over 100 countries worldwide.

Creating Solutions Together.



Low-voltage Power Distribution Products



Transformers, Med-voltage Distribution Products



Power Monitoring and Energy Saving Products



Power (UPS) and Environmental Products



Compact and Modular Controllers



Servos, Motors and Inverters



Visualization: HMIs



Edge Computing Products



Numerical Control (NC)



Collaborative and Industrial Robots



Processing machines: EDM, Lasers



SCADA, analytics and simulation software

Mitsubishi Electric's product lineup, from various controllers and drives to energy-saving devices and processing machines, all help you to automate your world. They are underpinned by software, innovative data monitoring, and modelling systems supported by advanced industrial networking and Edgecross IT/OT connectivity. Together with a worldwide partner ecosystem, Mitsubishi Electric factory automation (FA) has everything to make IoT and Digital Manufacturing a reality.

With a complete portfolio and comprehensive capabilities that combine synergies with diverse business units, Mitsubishi Electric provides a one-stop approach to how companies can tackle the shift to clean energy and energy conservation, carbon neutrality and sustainability, which are now a universal requirement of factories, buildings, and social infrastructure.

We at Mitsubishi Electric FA are your solution partners waiting to work with you as you take a step toward the realization of sustainable manufacturing and society through the application of automation. Let's automate the world together!

Country/Region, Sales office, Tel/Fax

<p>USA and Canada mitsubishi electric automation, inc., 500 Corporate Woods Parkway, Vernon Hills, IL60061, U.S.A Tel :+1-847-478-2100 Fax:+1-847-478-2253</p>	<p>Mexico mitsubishi electric automation, inc. Mexico Branch Boulevard Miguel de Cervantes Saavedra 301, Torre Norte Piso 5, Int. 502, Ampliacion Granada, Miguel Hidalgo, Ciudad de Mexico, Mexico, C.P.11520 Tel :+52-55-3067-7500</p>	<p>Brazil mitsubishi electric do brasil comercio e servicos ltda. Avenida Adelino Cardana, 293, 21 andar, Bethaville, Barueri SP, Brasil Tel :+55-11-4689-3000 Fax:+55-11-4689-3016</p>
<p>Germany mitsubishi electric europe b.v. German Branch Mitsubishi-Electric-Platz 1, 40882 Ratingen, Germany Tel :+49-2102-486-0 Fax:+49-2102-486-7780</p>	<p>UK mitsubishi electric europe b.v. UK Branch Travellers Lane, UK-Hatfield, Hertfordshire, AL10 8XB, U.K. Tel :+44-1707-28-8780 Fax:+44-1707-27-8695</p>	<p>Ireland mitsubishi electric europe b.v. Irish Branch Westgate Business Park, Ballymount, Dublin 24, Ireland Tel :+353-1-4198800 Fax:+353-1-4198890</p>
<p>Italy mitsubishi electric europe b.v. Italian Branch Campus, Energy Park Via Energy Park 14, Vimercate 20871 (MB) Italy Tel :+39-039-60531 Fax:+39-039-6053-312</p>	<p>Spain mitsubishi electric europe, b.v. Spanish Branch Carretera de Rubi, 76-80-Apdo. 420, E-08190 Sant Cugat del Valles (Barcelona), Spain Tel :+34-935-65-3131 Fax:+34-935-89-1579</p>	<p>France mitsubishi electric europe b.v. French Branch 25, Boulevard des Bouvets, 92741 Nanterre Cedex, France Tel :+33-1-55-68-55-68 Fax:+33-1-55-68-57-57</p>
<p>Czech Republic mitsubishi electric europe b.v. Czech Branch Pekarska 621/7, 155 00 Praha 5, Czech Republic Tel :+420-734-402-587</p>	<p>Poland mitsubishi electric europe b.v. Polish Branch ul. Krakowska 48, 32-083 Balice, Poland Tel :+48-12-347-65-00</p>	<p>Netherlands mitsubishi electric europe b.v.-Benelux Beechavenue 111, NL-1119 RB Schiphol-Rijk, Netherlands Tel :+31 297-250-350</p>
<p>Sweden mitsubishi electric europe b.v. (Scandinavia) Hedvig Mollersgata 6, 223 55 Lund, Sweden Tel :+46-8-625-10-00 Fax:+46-46-39-70-18</p>	<p>Turkey mitsubishi electric turkey elektrik urunleri a.s. Serifaili Mahallesi Kale Sokak No:41 Umraniye / Istanbul Tel :+90-216-969-2500 Fax:+90-216-661-4447</p>	<p>UAE mitsubishi electric europe b.v. Dubai Branch Dubai Silicon Oasis, P.O.BOX 341241, Dubai, U.A.E. Tel :+971-4-3724716 Fax:+971-4-3724721</p>
<p>South Africa ADROIT TECHNOLOGIES 20 Waterford Office Park, 189 Witkoppen Road, Fourways, South Africa Tel :+27-11-658-8100 Fax:+27-11-658-8101</p>	<p>China mitsubishi electric automation (china) ltd. Mitsubishi Electric Automation Center, No.1386 Hongqiao Road, Shanghai, China Tel :+86-21-2322-3030 Fax:+86-21-2322-3000</p>	<p>Taiwan mitsubishi electric automation (taiwan) co., ltd. 6F, No.105, Wugong 3rd Road, Wugu District, New Taipei City 248019, Taiwan Tel :+886-2-2299-2499 Fax:+886-2-2299-2509</p>
<p>Korea mitsubishi electric automation korea co., ltd. 7F to 9F, Gangseo Hangang Xi-tower A, 401, Yangcheon-ro, Gangseo-Gu, Seoul 07528, Korea Tel :+82-2-3660-9569 Fax:+82-2-3664-8372</p>	<p>Singapore mitsubishi electric asia pte. ltd. 307 Alexandra Road, Mitsubishi Electric Building, Singapore 159943 Tel :+65-6473-2308 Fax:+65-6476-7439</p>	<p>Thailand mitsubishi electric factory automation (thailand) co., ltd. 101, True Digital Park Office, 5th Floor, Sukhumvit Road, Bang Chak, Prakanong, Bangkok, Thailand Tel :+66-2682-6522-31 Fax:+66-2682-6020</p>
<p>Vietnam mitsubishi electric vietnam company limited 11th & 12th Floor, Viettel Tower B, 285 Cach Mang Thang 8 Street, Ward 12, District 10, Ho Chi Minh City, Vietnam. Tel :+84-28-3910-5945 Fax:+84-28-3910-5947</p>	<p>Indonesia PT. MITSUBISHI ELECTRIC INDONESIA Gedung Jaya 8th Floor, JL. MH. Thamrin No.12, Jakarta Pusat 10340, Indonesia Tel :+62-21-31926461 Fax:+62-21-31923942</p>	<p>India mitsubishi electric india pvt. ltd. Pune Branch Emerald House, EL-3, J Block, M.I.D.C., Bhosari, Pune-411026, Maharashtra, India Tel :+91-20-2710-2000 Fax:+91-20-2710-2100</p>
<p>Australia mitsubishi electric australia Pty. Ltd. 348 Victoria Road, P.O. Box 11, Rydalmere, N.S.W 2116, Australia Tel :+61-2-9684-7777 Fax:+61-2-9684-7245</p>		



Mitsubishi Electric's e-F@ctory concept utilizes both FA and IT technologies, to reduce the total cost of development, production and maintenance, with the aim of achieving manufacturing that is a "step ahead of the times". It is supported by the e-F@ctory Alliance Partners covering software, devices, and system integration, creating the optimal e-F@ctory architecture to meet the end users needs and investment plans.



MITSUBISHI ELECTRIC CORPORATION
 HEAD OFFICE: TOKYO BLDG., 2-7-3, MARUNOUCHI, CHIYODA-KU, TOKYO 100-8310, JAPAN